

RADICAL SOFTWARE

5

and The Realistic Hope Foundation

Visionary technology. Process evolution. You are the media. Feedback-feedforward. Networking. The Second Coming of Television. Videosphere :: New Clear Vision. Electronic literacy. High Tech. Bio-technology. Organic re-focusing. Alternatives Transformations in media America . . .

THE FUTURE OF RADICAL SOFTWARE

Radical Software began in early 1970 as print connection between the then few people who were working in alternate television. The first issue appeared in the summer of 1970 and was initially mailed free to about 700 names we'd compiled. We then started distributing to a few bookstores and later reprinted. At the time we decided to make it a quarterly and pledged ourselves to doing only six issues. Theoretically, the last issue would have appeared in December of 1971.

Included in the six issues was a book we did called *Guerrilla Television* which we decided to make issue number six. Because it got done before this issue, number six actually appeared before number five.

Meanwhile, the task of doing *Radical Software* has turned into a chore because not only do we do our own production (through layouts and supervision of printing), but we also do distribution ourselves. This means excessive bookkeeping, correspondence, trips to the post office; and shi-twork roles for some of us. While we enjoy the intelligence-gathering and design roles of *Radical Software*, the drudgework takes too much time from other things like making videotape.

In short, if we are to go on with *Radical Software* we have to have outside support services. Thus, we have made an agreement with a publishing company called Gordon and Breach to have them take over the production and distribution jobs leaving us to devote all of our time to the editorial role.

Gordon and Breach is a low-key publishing company which concentrates in the area of scientific reprints and journals. It also has a subsidiary for distribution, including an extensive mail order and institutional network.

We have agreed to regularize our format (at 9" by 12"—the same as this issue) and commit ourselves to a second volume of nine issues (the first six issues having been volume one) over a year's time beginning in September of this year.

Each issue will sell for \$1.95 at newsstands and bookstores. Naturally, we're offering a reduced subscription price. It will be \$12.50 for all nine issues, or a savings of \$5.05 over the total single copy price (and roughly equal to the current cost of the quarterly *Radical Software*: four times \$3.00). Single copies will not be available through the mail.

What does this mean to subscribers? Simply that you will no longer deal with us directly but with a more efficient distribution company. Moreover, Gordon and Breach will also be distributing the back issues of *Radical Software* (which still can be purchased individually. See offer in the back of this issue).

Thus, we have another new address for subscriptions: *Radical Software*, Suite 1304, 440 Park Avenue South, New York, New York 10016.

What does this mean to contributors? Nothing different. All editorial control and processing of information remains with us. Any correspondence you have with us comes directly to another address: *Radical Software*, Post Office Box 543, Cooper Station, New York, New York 10003.

That is a different address from our current one because we are giving up our loft in New York City and decentralizing (see *The Raindance Story* below). We will be working on future issues in Manhattan, upstate New York, California, and wherever else we go. So keep the material coming to us.

Most important is this: We want to let others do whole issues of *Radical Software*. We've already tried this in part with the California and Canada sections that were done in the last issue (number four). It worked very well.

Our idea is that there are groups and individuals who have codified enough diverse information that it should be circulated. But in many instances they lack the means to do so. To do an actual book requires a lot of time and more than casual information.

With a publication like this, however, it's possible to as soft-edged as you want. Thus, if you think you could do an issue, get in touch. We will provide a production budget (50% advanced—in cash) and an advance against a guarantee of some royalties on the issue you do. It won't be fabulously lucrative financially, because we ourselves are a non-profit group. But we can meet all expenses.

Or, if you think you would want to do part of an issue then we can provide partial expenses. If you just have a page or two to submit, do it as camera-ready copy (i.e. layed out) and we promise it will be included in a future issue. It doesn't have to be about video, of course.

We have already discussed the above with Antioch College in Baltimore, and people in Canada and California, and expect that they will each do an issue of the next volume. The first three issues we plan to do ourselves.

So, *Radical Software* goes on as an experiment in working towards a true information economy. We hope this will generate a high variety of inputs as there is obviously a genuine need for our type of information in the survival space.

As for actual videotape information, that function will be taken over by Raindance, and information on a video subscription service appears next to the *Radical Software* subscription offer in the back of this issue.

RADICAL SOFTWARE

EDITORS: Dudley Evenson, Michael Shamberg

CONTRIBUTING EDITORS: Dean Evenson,
Jodie Sibert, Megan Williams, Ann Arlen

ASSOCIATE EDITOR: Beryl Korot

HELP: Tom Klein, Ira Schneider

GORDON AND BREACH

NEW YORK • LONDON • PARIS

CONTENTS

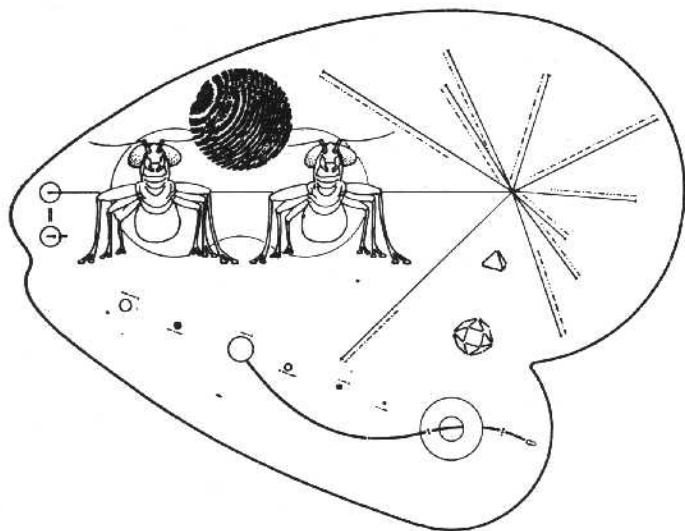

THE RAINDANCE STORY:

THE FUTURE OF THE PUBLISHERS OF RADICAL SOFTWARE	4
---	---

NETWORKS AND OTHER NATURAL SYSTEMS:

OPEN ENDED NERVOUS SYSTEM, by Dean Evenson	6
NEURAL NOTES FOR THE VIDEO WORKER, by Dimitri Devyatkin	10
COSMIC MOTION PICTURE MECHANISM, from Autobiography of a Yoga by Yogananda	12
AN AMERICANIZED PLANET: THE DOMINANCE OF SCIENCE, from Last and First Men by Olaf Stapledon	13
BOSTON VISIONARY CELL, by Paul Laffoley	14
TELEPA-VISION: THE COMMUNICATION OF MENTAL IMAGES, by Tom Bender	15
ALPHA RHYTHM, by Marjorie Kawin-Toomin	16
VITAL SIGN INTERGRATION, by John Sowaal	17
COMPUTER ART, by Manfred Mohr	18
VIDEO SOMA FEEDBACK, by Merrily Paskal.....	20
ATTITUDES TOWARD TECHNOLOGY, by David Graham	22

ECOLOGICAL LITERACY:

CONSTRUCTING NEW LIFE STYLES FROM AN ECOLOGICAL PERSPECTIVE, by Clifford Humphrey	30
ENVIRONMENTAL CONFERENCE IN SWEDEN	32
UP AGAINST THE ENVIRONMENT OR OURSELVES?, by Gregory Bateson	33
RE-CYCLING BIOTOPOLOGY 1972: NOTES FROM ECOLOGY TOOL AND TOY, by Warren Brodey	34
SHIRLEY CLARKE'S VIDEO TEEPEE'	37
FROM CRUCIFIXION TO CYBERNETIC ACUPUNCTURE, by Paul Ryan	38

VIDEO AND HEALTH CARE:

INTRODUCTION	41
USING VIDEO IN HEALTH CARE, by People's Video Theater	42
SECOND GENERATION MEDICINE, by Michael Schwartz	44

LEARNING

GESTALT LEARNING, by John Grayson	47
TOWARDS A VIDEO COLLEGE, Antioch College in Baltimore	48
PACIFIC HIGH SCHOOL APPRENTICESHIP PROGRAM	49
LEARNING, by David Graham	50
COMMUNITY CENTER FOR TELEVISION PRODUCTION, by Ralph Hocking and Ken Dominick	52
ALTERNATE EDUCATION CONFERENCE, Videotape Excerpts	53

COMMUNITY:

ICONICS, by Chris Rudy	54
PORTABLE VIDEO: THE NATURAL MEDIUM, by Dudley	55
VIDEO PONY EXPRESS, by Peter Berg	58
MEDIA BUS AT MAPLE TREE FARM, by the Videofreex	60
MAYDAY IN WASHINGTON: THE VIDEOFREEX JOURNAL, by Davidson Gigliotti	61
GLOBAL VILLAGE, by John Reilly and Rudy Stern	62
CHALLENGE FOR CHANGE	64
VIDEO OUTREACH, by Yolande Vaiquette and Peter Cuozzo	66
ALTERNATE DISTRIBUTION SYSTEMS, by Jes Harris and Allen Dragge	68
VIDEO IN PRISON, by Ann Arlen	70

VIDEOTAPES FOR SALE AND/OR EXCHANGE:

200 DIFFERENT VIDEOTAPES, by Ant Farm Video; Antioch College in Baltimore; Antioch College in Ohio; Community Video Center in Washington, D.C.; Dimitri Devyatkin; Frank Cavestani; Global Village; Johnny Videotape; Media Access Center; NCV Video; Eric Siegel; People's Video Theater; Raindance; the Vasulkas; Videofreex.....	71
---	----

CABLE TELEVISION:

COMMUNITY ACCESS VIDEO, by H. Allan Frederiksen	79
INTRODUCTION	80
THE SECOND COMING OF TELEVISION, by Ann Arlen.....	81
THE RADICAL SOFTWARE CABLE-TV REPORT: Cable Television Information Center, Books, Business, Projects, Conferences	86
WOODSTOCK CABLE, by Ken Marsh	90
APRIL VIDEO CONFERENCE AND JAMBOREE	92
CABLE-TV IN NORTH CAPE MAY, NEW JERSEY, by Carole and Maxi	93

VIDEO DIRECTORY

ALMOST EVERYONE WE KNOW, WHAT THEY'RE DOING, AND WHERE.....	94
---	----

VIDEO HARDWARE:

ERIC SIEGEL'S VIDEO REPORT, by Eric Siegel.....	108
A RADICAL SOFTWARE STATE-OF-THE-ART-REPORT	109
DO-IT-YOURSELF HIGH TECHNOLOGY: HOW TO INSTALL A TIVICON LOW-LIGHT VIDICON TUBE IN A PORTA-PAK CAMERA	114

PRINT RESOURCES:

A LIST OF USEFUL BOOKS	116
GUERRILLA TELEVISION ADVERTISEMENT	118
RADICAL SOFTWARE VOLUME ONE (BACK ISSUES) ORDER FORM.....	119
RADICAL SOFTWARE VOLUME TWO (FUTURE ISSUES) ORDER FORM	120

We thank the New York State Council on the Arts whose partial support has made this issue possible.

Copyright © 1972 by RAINDANCE FOUNDATION: In the first issue of RADICAL SOFTWARE we established what we called a Xerox mark, or an x in a circle: (X). This meant "do copy: information is access, not ownership." Library of Congress catalog number: 72-79447. ISBN 0 677 109709 (cloth). Printed in the United States of America.

REVOLUTIONARIES ARE JUST ANOTHER SPECIAL INTEREST GROUP



RAINDANCE
THE REALISTIC HOPE FOUNDATION

THE RAINDANCE STORY

Raindance* is the spiritual and legal entity which publishes *Radical Software*. We began in the fall of 1969 primarily to explore the possibilities of the then new medium of portable video. Since then, we've gone through people changes and physical and metaphysical relocations.

Because we were among the first into alternate television, and especially because we disseminated print about it (print and the mails, as medium and network, will keep your name in the public space much more readily than video. At this point, anyway), we have always filled a kind of public service role. Now that many more people have become aware of the possibilities of videotape, the demand for information has increased.

Unfortunately, it's increased so much that our physical overhead doesn't serve us as much as strangers. In other words, an address and a phone number guarantee that anyone can find you and you thus become a convenience for a lot of unfocused people. Moreover, there are demands on equipment which we feel we cannot fulfill, but that creates resentment.

We support ourselves in three basic ways:

1. Funding from the New York State Council on the Arts. Over the past two years we've received about \$55,000 (as have several other video groups in New York). While political pressures generated a lot of bad feeling the first time grants we're given, it should be said that the N.Y.S.C.A. is virtually the only funding institution in America that is supporting a lot of alternate video activity. While a few other foundations have given money in this area, they have done so very conservatively by donating large sums to one conservative institution. Only the N.Y.S.C.A. has chosen to support large scale innovation by many groups and individuals without demanding that they jump through hoops by conforming to the prejudices of its administrators.

2. Sales of Radical Software. This brings us enough to meet our physical overhead (rent, electricity, telephone) as well as its own production expenses. Salaries have come from the State Council grants, however.

3. Consultancies. Several times a month we go to universities and talk, demonstrate hardware, and show videotape. This brings us anywhere from \$100-500 depending on how ambitious the school is.

There is, of course, a fourth possible source of self-support: the sale of video software. Right now, we sell about one tape a week (and exchange a tape a week). We enjoy doing this because it seems to have a genuine effect. And we want to increase it.

Thus, we feel that one of our next moves should be towards producing software which can offer a fulltime alternative to television in America. So while others are turning their energies to championing public access plans (without actually making video themselves) and community programming (very often for communities other than their own, however), we choose to spend part of the near future exploring video as video so that the conceptual promise of the medium may be fulfilled in television that people are enthusiastic about watching. We are especially interested in the development of cable television as an alternate habit pattern in people's lives (The influence of broadcast teevee is not that it offers up something people like to watch every now and then, but that it is an integral part of their environment. Similarly, cable television won't be a true change unless viewers come to expect an ongoing alternative from it, not just a different type of show every now and then).

Other areas which interest us are video in education and video in environmental planning. Projects have been initiated in each of those areas.

Towards those ends, we are giving up our loft in New York City and decentralizing. Some of us will be working in California for a while, others in upstate New York, and the rest will remain in Manhattan under low-profile. Each of us will have adequate video equipment. (You only need a studio if you're doing studio productions. But if you're shooting on location, you can always edit anywhere there's electricity because the equipment is so compact).

Not having a physical plant will save us at least \$1,000 a month, and in no way diminish our output or detract from our commitments. We will continue to publish *Radical Software*. Moreover, we will maintain a mailing address and a telephone answering service. But we are now free to be as mobile as our video equipment will allow us.

Our new mailing address and telephone number will be:

RAINDANCE
Post Office Box 543
Cooper Station
New York, New York 10003

(212) 687-4210



The members of Raindance are: Dean Evenson, Dudley Evenson, Beryl Korot, Ira Schneider, Michael Shamberg, Jodie Sibert, and Megan Williams.

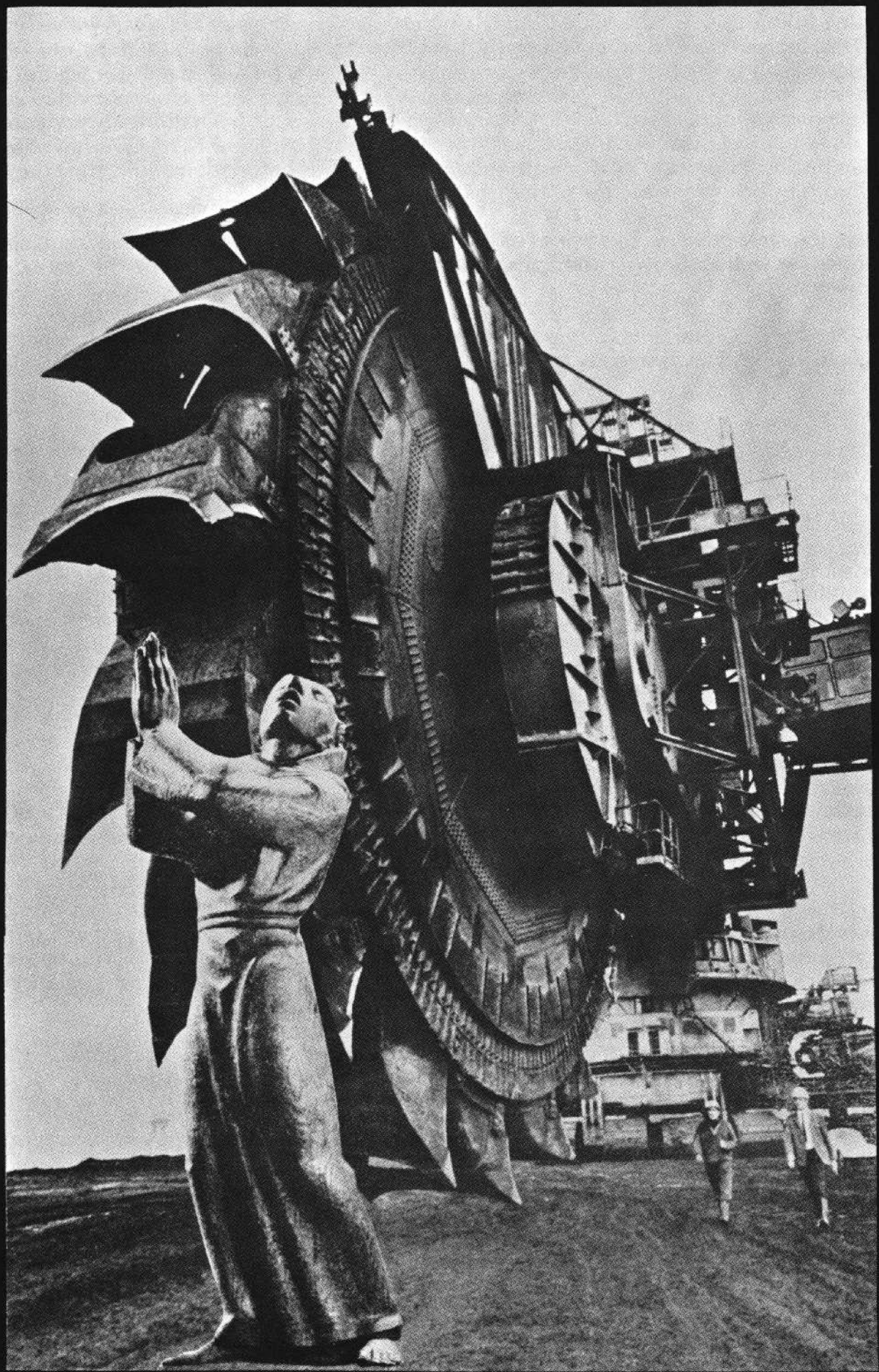

collage: Jodie Sibert

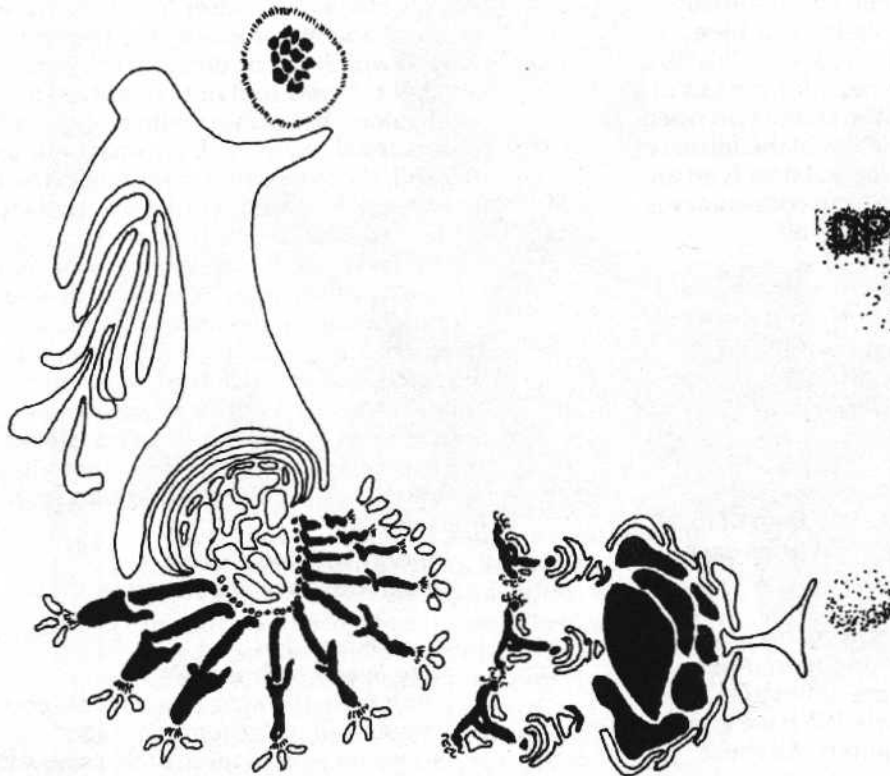

OPEN
ENDED
NERVOUS
SYSTEM

by DEAN EVENSON

A nervous system is close at hand whereby men of love can flow into each other over great distances, a flow going in all directions to all people. With satellites, cassettes, cable systems, computers interfaced with each other, electronic energy can go freely around the globe. Increasing our contact with other psyche via technology involves a recognition that the technology itself, however honest it is, is largely impotent spiritually unless it is used with a cosmic awareness. Even then it is a paltry substitute for true oneness via telepathy or via systems based totally on a spiratual love flow.

Neither modern man nor his creations in material form constitute the natural universe except in a few very conscious occasions because man's pattern of thought is one of destroying nature, not living with it. He has misinterpreted his relationship with the machine as a self-contained cosmic situation, when in reality, man relating through the machine (as a tool) to the universe and himself is a much more fulfilling evolutionary concept. His inconspicuous slot in the cosmos leaves him frustrated and causes him to build falacious systems and structures which ostensibly destroy any encroachment of that fearsome reality NATURE. Always limiting flow, not allowing the blood to circulate, the air to refresh.

Oneness on a level of human beings requires total communication. The life source in each of us wants to join with others, but is limited on an elementary

plane by our inability to spiritually and therefore physically relate to one another. Our inborn spirit is pushing out through our physical support system (our body) into the real world and hopefully to another support system of another life source. *I love you and want to serve you. That's what this paper is. These words are for you. This typewriter is part of me now but its words are a part of you when you read them.* And they can be repeated so anyone can relate their inside to many people's lumps of matter containing for the most part repressed, frustrated spirits.

Our frustration at being confined to our bodies should be realized and once known overcome by the use of tools, not to lash out in destruction, but to reach others who are equally frustrated. The ego is a blockage of free flow and is related to our identity with our bodies, our pile of matter. Our nervous system can be connected to all of the energy going on around us. The energy which comes in on many frequencies and intensities.

Cosmic energy
Life energy
All love

We have tools with us to help us relate to this flow. Our bodies are capable of placing our soul self source in the flow of love and energy. Our body is the closest matter and best related to that flow. We are the centers of life. Centers which are never centered always changing.



Our nervous system is the primary system relating our soul self world to the external reality. Through the sensory apparatus such as eyes, pain receptors, heat receptors, etc. we are connected to the outside. These apparatus upon stimulation produce an electrical flow in the nerves attached to it. This flow then activates our brain and spine, informing us of changes occurring. We react to the changes in open new ways if we have freed ourselves of the fetters of our fathers' frustration. This electrical flow is an energy flow carried by electrons whose consistency is primarily energy, not much matter at all.

Our bodies also contain emitters of energy. Our bodies are manifestations of energy. And the well being of the spirit they enclose is transmitted through this $E = MC^2$ matter we are vibrating. Each of us to our eyes is energy vibrating at a multitude of frequencies of energy. $E = hv$
 $hv = MC^2$

The energy of your soul self source flows out through matter into the universal medium of matter. Molecules flow into each other. Caress each other with vibrations of love.

What we're working toward now in this new age with the use of electronics is extending our nervous systems to a global, a universal and ultimately a cosmic scale through the use of tools. We have audio tape recorders, VTR's and computers. All these things use the same kind of flow as our closest tool: our nervous system. The structures are different mainly because we are at a primitive stage in developing our system toward their biological counterparts.

What we're talking about is tapping our psychic energy through our body through our nervous system out of our body into an external system which carries information—energy in a way similar to our nervous system's flow.

Videotape is a tool for us to use in increasing our flow on a rudimentary level. It is probably right now the best tool outside our bodies because it transfers energy efficiently (closer to natural nervous system process) and encompasses the two spectrums of energy to which our bodies are well attuned: sound and light. A new tool not connected to the material world alone but pulsing with energies closer to the nonmaterial realm of electromagnetic awareness. But still, these whirring magnetic marvels are inert energy drains which require external inputs on all levels to sustain them. They are tools to transmit ourselves through. Machines can never match the capability of a human being as a communications medium. You are the medium. You, a living being, have a much greater capacity for energy emission and reception on multiple levels, even levels which we haven't been capable of measuring. A machine loses energy in the process of transference between the source and the recipient. There's just no way around this particular generation gap. Machines are inert systems

Energy sucking systems.

Machines have enamored us

awed us

seduced us

into lives which are oiled by

their own offspring of worthless goods.

We started with them years ago

some we worshipped, others saved our time

Soon we ended up in lines-

on conveyor belts belching and farting

We are not machines, we are not inert things

We are the sources of the life force.

When our bodies love our mind and soul,

When we listen to silence. When we love all. Accept, humble and ask not of others but of ourselves.

Not relating to those programed thought patterns

provided us by those who would have us worship

and love matter alone.

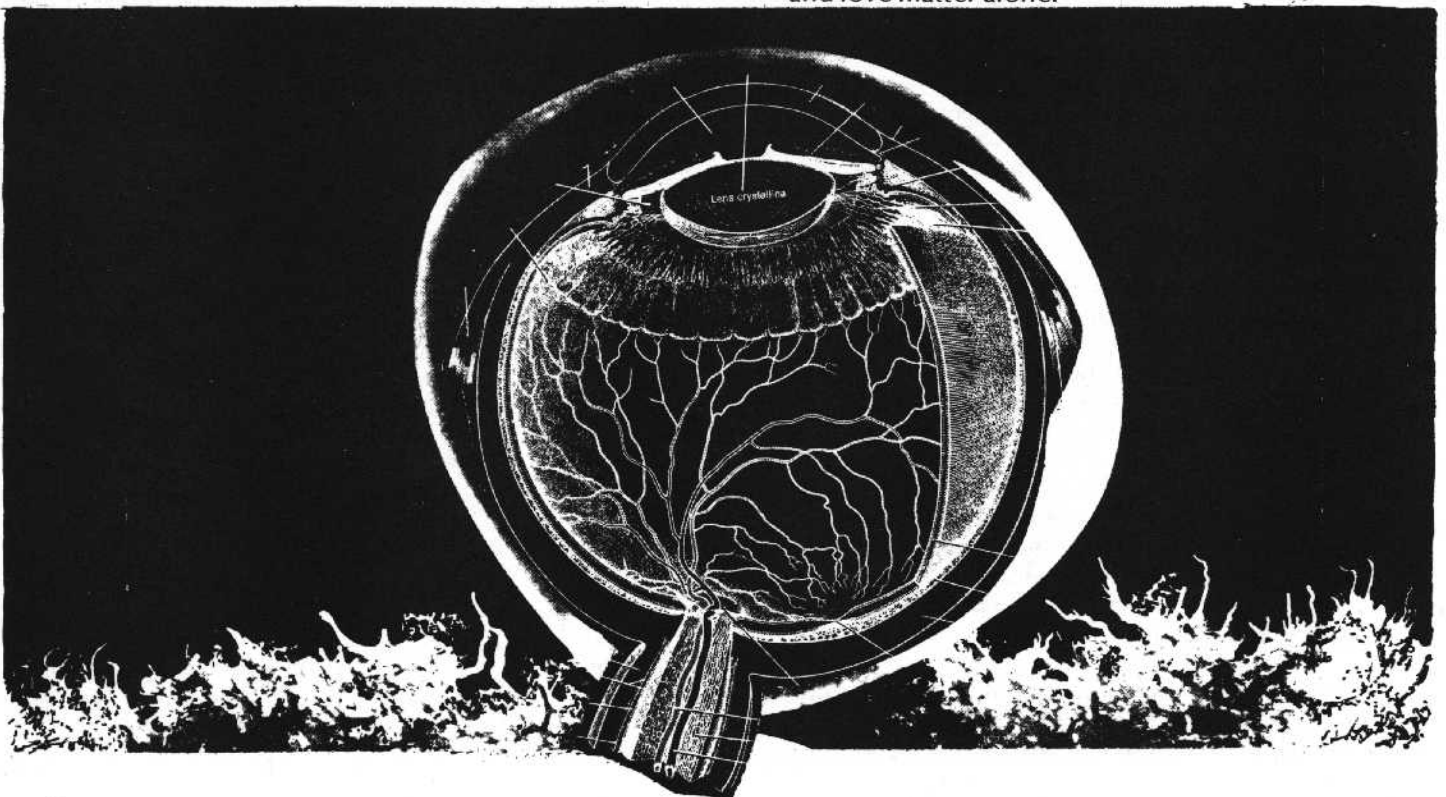



A.D.1000



BIRTH OF CHRIST

500 B.C.



1200

LATE BRONZE AGE

1500

MIDDLE BRONZE AGE

2000

EARLY BRONZE AGE

2500 B.C.



The technology is teaching us that our environment is much more complex than the perceived reality would have us believe. We can tune into an infinite number of energy bandwidths flowing through our planet, our bodies, and decipher different patterns and amplitudes at each level or bandwidth of energy. We are also transmitting/generating an incredible amount of energy at different bandwidths causing a pollution of monotonous information that inundates all our being. Urban environments with their high density of people and technology are clogged with man made energy cycles. Our electrical wires are surrounded by a constantly fluctuating field of magnetic force. Our radio transmissions, our jack hammers, our motors, our televisions (each emitting a 15,000 cycle sound) all are intensifying man's subserviance to technology. Technology which stemmed from his attempts to obliterate nature and make life "easier" has created an environment which for the most part is irritating and unhealthy for sustaining life.



collage: Jodie Sibert

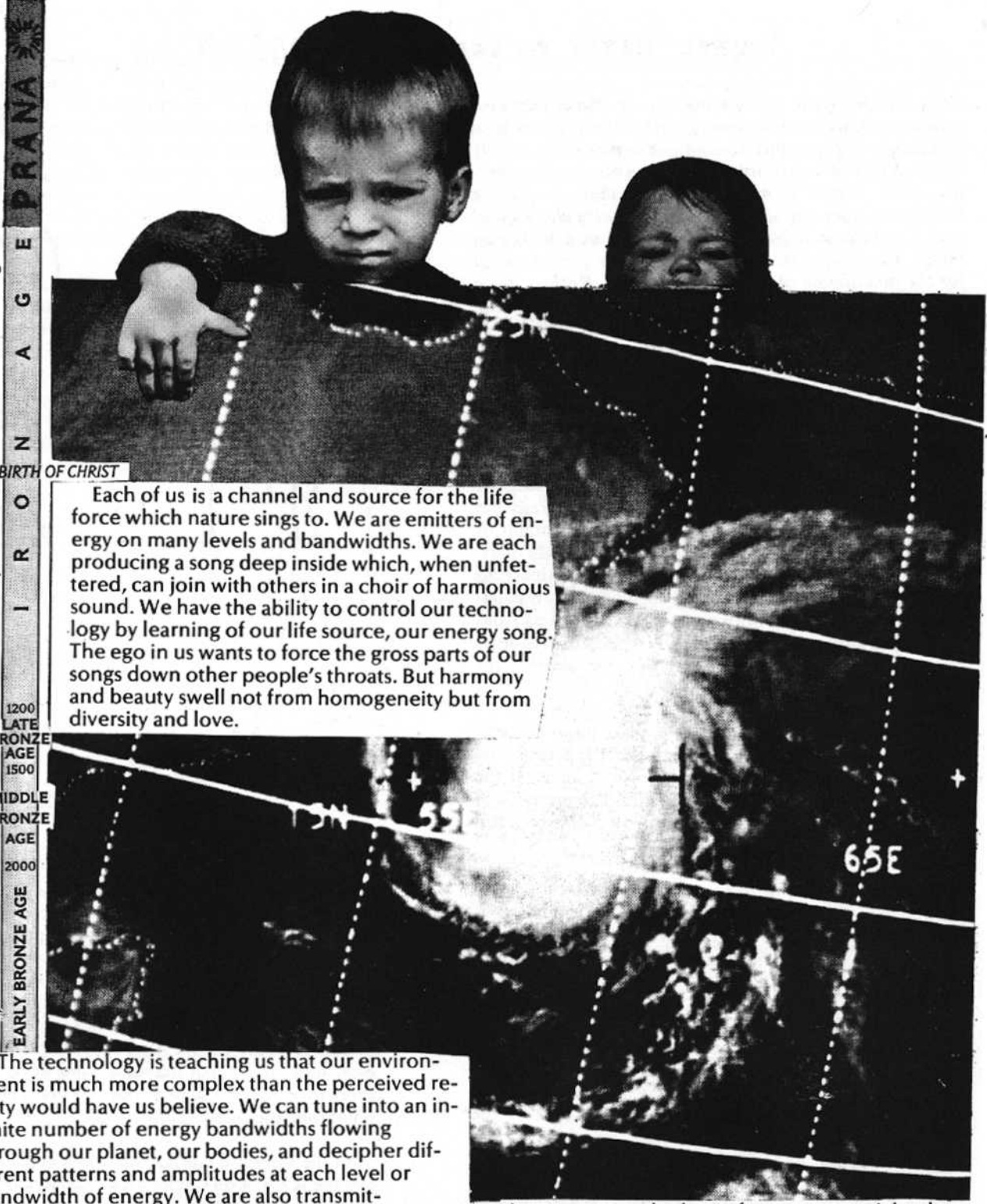

Each of us is a channel and source for the life force which nature sings to. We are emitters of energy on many levels and bandwidths. We are each producing a song deep inside which, when unfettered, can join with others in a choir of harmonious sound. We have the ability to control our technology by learning of our life source, our energy song. The ego in us wants to force the gross parts of our songs down other people's throats. But harmony and beauty swell not from homogeneity but from diversity and love.

The monotone rhythms of progress won't be the sounds that save us from an engulfment by their refuse. We can't clean up the environment with more machines because they too have wastes. It seems the least pollution occurs when technology is used for information flow, unaltered by merchandizing and money lending. The choice is ours to continue our planet or abandon it to the rushes of stagnation. We can't expect to do it through dogma or rhetoric (religious, political, or otherwise) both of which are shields for shutting down the communication process right in our own brains. We have to do it ourselves on personal levels with our own energy and sharing the things we learn with others.

NEURAL NOTES FOR THE VIDEO WORKER

"The Unique value of consciousness is that it carries a residue of neural activity one instant to the next, giving a semblance of continuity to what, in actual fact, may be extremely brief and isolated neural events. In this sense, it may be likened to a television tube that glows for a fraction of a second after it has been electrically excited and thus affords a continuous rather than a flickering image. Consciousness is not and never has been essential for the functioning of the nervous system. Rather, it is a supplement to the operations of the spinal cord, the brain stem, and the autonomic nervous system—all of which can and do function without it."

Human Design by William S. Beck
Harcourt, Brace, Javanovich Textbook

It is of great value to have some concept of the workings of the electrochemical meat by which we perceive and experience all events. For a worker in the world of video, it is significant that the television images succeed each other at a rate of 30 times a second, whereas the human brain can perceive nowhere near that amount of input. No human being has ever exceeded 100 bits of information per second. If you consider that the American standard has 525 horizontal rows, each of which is capable of effervescing at 8 discrete levels of brightness from black to white, at 30 frames per second, television is emitting 8 billion bits of information per second, for display on the screen.

The principle of scansion is of immense importance to the functioning of the television camera and screen, and is likewise essential to the three neural systems of the Auditory, Optical and Cerebral Cortex. The principle of scansion is actually the exchange for one dimension in time for one in space, or vice versa.

In television, the role of scansion is as follows: first, in the camera, the field of view is scanned by a small electron gun, affording the covering of a larger area than if there was no scanning motion. The sacrifice of misrepresentation because of the slight amount of time spent in the glance at a single point, is compensated for by the ability of the phosphorescent screen to glow for a sufficient time that the image seems continuous. Therefore, there is a slight delay in the actual perception of a significant new change in the picture which amounts to less than 1/30th of a second. More space is covered by the camera by its scanning motion, even though there is a slight corruption of the information through the scansion. The phosphorescent screen works just the exact opposite way from the camera. The signal is retranslated back into the wide display of information from the camera's scanned information.

The three instances in the brain are more like the television camera's scanning than the tube, in that there is a succinct signal of significant information abstracted from the wide display of information. In the Auditory Cortex, octaves occupy equal areas of cortex. Within the range, all frequencies are fed into the cortex, but the cortex abstracts the universal of the interval between notes, or a certain chord, regardless of what the actual notes are. That is why the quality of a fifth is constant, whether played in the high notes, or low notes.

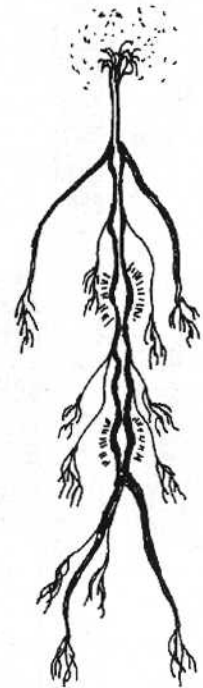
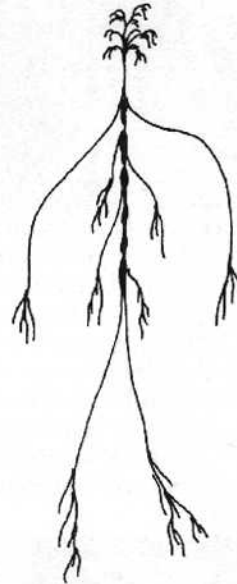

by Dimitri Devyatkin

In the Optical Cortex, there is a reflex type mechanism which directs the eyes to immediately turn towards whatever enters the field of vision. There is a scansion of the entire field, but if an incoming impulse collides with the sweep, the corresponding eye muscle is activated by its motor neuron. There is the slight delay of response, due to, among other causes, the time consumed before a given point is scanned. This is in contrast to the eyes of insects, etc., for their eyes, though multiple in number, each look at a separate scene, and never can there be more eyepower brought to bear on the viewing of a given point than the single primitive eye.

In the Cerebral Cortex, there is a constant undulating change in the level of electrical activity. The entire brain consists of about 10 billion nerve cells, all interconnected by very complex switching systems. An initial firing of a single neuron can cause a long sequence of echoing impulses, all producing a constant electrical activity. That this electricity should read out on graphs in classic, regular waveforms, is to be attributed to the high level of internal organization. These waveforms are known as the alpha wave, which is normal adults, over the age of 17, is usually of the order of 8 to 12 cycles per second. The voltages are of the order of 0 to 300 micro-volts v. There are also Beta waves, which are faster, usually 18 to 32 cps, normally thought to be associated with alertness, problem solving and the like. And then there are also Delta waves, much slower at 8 cps.

The Cerebral Cortex is believed to function as the clearing house in which all inputs and outputs, receptors and motor effectors respectively, are monitored. As an incoming sensory impulse enters the grid or field of scansion, it is directed towards its proper afferent, causing the movement of the corresponding motor neuron. The sacrifice is again in time—of a slight delay in the immediacy of response until the proper input is monitored, and the gain is in number of possible inputs.

The human brain is unique in the quality that it can draw an abstraction from a mass of data. Even our nearest Simmian progenitors are incapable of the simple association between stimuli received through different mode channels of the same object. Experiments have shown that a monkey cannot choose the shape of an orange held out of sight, upon being shown the visual representation. Therefore, neurophysiologists believe that it is in the human brain alone that there are "Cross-Modal Connections."

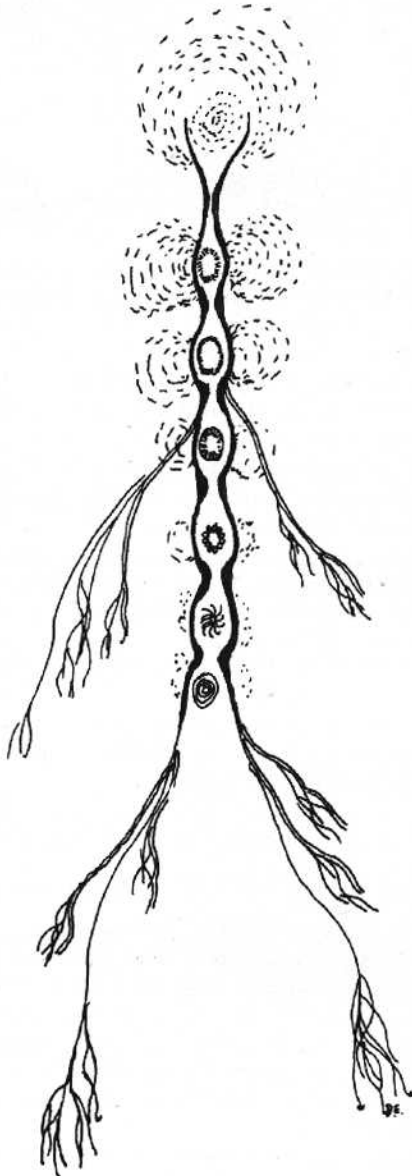

In the three instances of scansion in the human brain described above, the abstraction is a derivative of the total inputs. In the Optical Cortex, the eye is caused to respond to slight changes of an over-all sameness, like a fly flying in front of a white wall; it is the new, significant information to which the eye is drawn. In the Auditory Cortex, significant relationships between notes and chords are gleaned from the mass of sounds produced, explaining man's propensity to the 12-tone scale.

In the cerebral cortex, the abstraction made is the constant dichotomies to which man must be well adapted. To choose to do one thing is to choose not to do another. The human brain presents itself with reports as to the action of its inputs indicating reports from every receptor in the body. Certain stimuli have priority over others, but there is still a balance reached. For example, it seems likely that sudden pain is channeled through an express lane of the spinal cord, but that continuous pain can be modulated by diversion, emotions, and memories of prior experience. However, every receptor sends its signal whether activated or non-activated . . . There is a constant unchanging background. This constant scanned report from the receptors is called the generator current, and like the white wall behind the fly, it is the wall upon which significant new information is to be seen against.

We live in a world to which we are capable of transducing certain stimuli into electrical signals, and thereby we define our universe. For example, there is no known response of the human body to radio waves, although the list of stimuli to which we are receptive grows continuously: i.e. gyroscopic deflections, wind, infrared radiation, and ultra violet light. In the Renaissance, early experimenters with bats were given no support, and were even considered crazy when they said that they believed there to be sounds which the human ear was incapable of hearing. A telephone is a simple transducer. The charcoal granules colliding in the mouthpiece from the vibrations caused by your voice change the audible sound into an electrical signal, and then the earpiece translates the electrical signal back into sound. A transducer is a device which changes one form of energy into another, an essential component of any communicating or control system. Our receptor neurons act as transducers in that they indicate intensity of the stimulus through the frequency of the all-or-nothing impulse. The stimulus is changed from whatever form it arrived into an electrical signal. The myth that there are only five senses should be stricken. There are different receptors for the following stimuli: touch/pressure, gravity/motion, light, sound, blood pressure, blood oxygen level, and chemical substances, both gas (smell) and in solution (taste). Why is oxygen an odourless, tasteless, invisible, silent, weightless substance. Because we lack the capabilities to perceive it except for the carotid body in the circulatory system, which triggers response from the respiratory system to change the oxygen level in the blood. Imagine if we were differently constructed, or imagine the people occupying the distant galaxies. It is entirely explainable through survival of the fittest that these sensory devices are actually best adapted to the local environment, but imagine life on a planet with a much larger sun, causing entirely different ratios of all energies. Imagine the video these people would have!

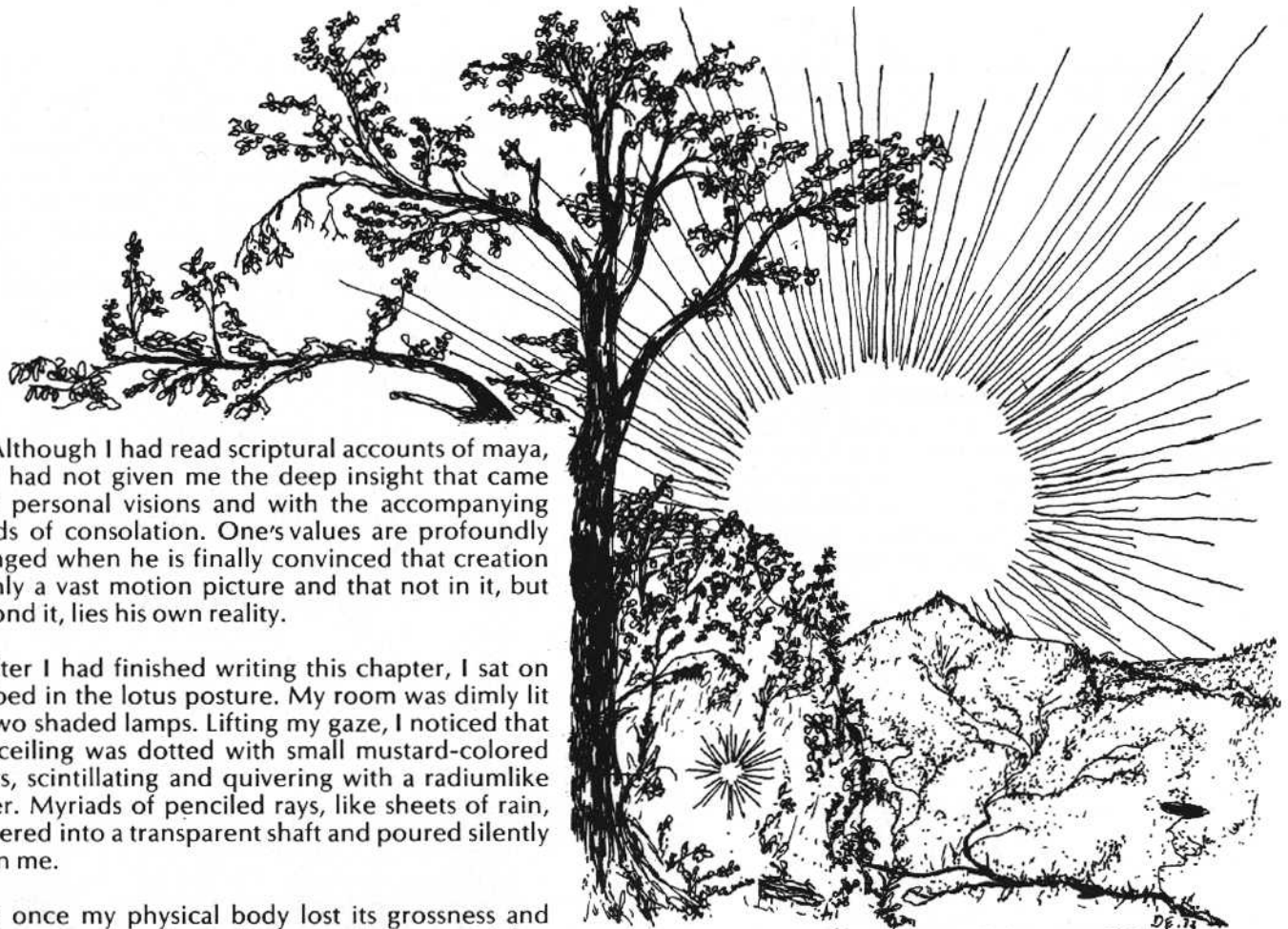

"Although I had read scriptural accounts of maya, they had not given me the deep insight that came with personal visions and with the accompanying words of consolation. One's values are profoundly changed when he is finally convinced that creation is only a vast motion picture and that not in it, but beyond it, lies his own reality.

After I had finished writing this chapter, I sat on my bed in the lotus posture. My room was dimly lit by two shaded lamps. Lifting my gaze, I noticed that the ceiling was dotted with small mustard-colored lights, scintillating and quivering with a radiumlike luster. Myriads of penciled rays, like sheets of rain, gathered into a transparent shaft and poured silently upon me.

At once my physical body lost its grossness and became metamorphosed into astral texture. I felt a floating sensation as, barely touching the bed, the weightless body shifted slightly and alternately to left and right. I looked around the room; the furniture and walls were as usual, but the little mass of light had so multiplied that the ceiling was invisible. I was wonder struck.

"This is the cosmic motion-picture mechanism," a voice spoke as though from within the light. "Shedding its beam on the white screen of your bed sheets, it is producing the picture of your body. Behold, the form is nothing but light."

I gazed at my arms and moved them back and forth, yet could not feel their weight. Ecstatic joy overwhelmed me. *The cosmic stem of light, blossoming as my body, seemed a divine reproduction of the light beams that stream out of the projection booth in a cinema house and make manifest the pictures on the screen.*

For a long time I experienced this motion picture of my body in the faintly lit theater of my own bedroom. Though I have had many visions, none was ever more singular. As the illusion of a solid body was completely dissipated, and as my realization deepened that the essence of all objects is light, I looked up the throbbing stream of lifetrans and spoke . . ."

Autobiography of a Yogi by P. Yogananda
Self-Realization Fellowship, Los Angeles

"The organ in the brain for thought-transference, both transmitting and receiving, is the pineal gland. If any one thinks intently on an idea, vibrations are set up in the ether which permeates the gland, thereby causing a magnetic current, which gives rise to a slight quiver or creeping feeling. This feeling indicates that the thought is clear and strong enough to be capable of transmission. With most people the pineal gland is not yet fully developed, as it will be in the course of evolution."

The Etheric Double by A.E. Powell, Theosophical Pub. House, Wheaton, Ill.

"Since the pineal gland is not the sole source of any hormone, removal of this organ is without appreciable effect in mammals."

Comparative Anatomy of the Vertebrates by George C. Kent

"We know that LSD operates via the natural chemicals of the body, and that the producer of these tremendously powerful chemical agents the pineal gland, is delicately responsive to these cosmic radiations we call visible light. Are there other emanations from the cosmos to which the pineal glands of certain exceptional individuals are also responsive?"

The Parable of the Beast by John N. Bleibtreau

AN AMERICANIZED PLANET, THE DOMINANCE OF SCIENCE

"Science now held a position of unique honour among the First Men. This was not so much because it was in this field that the race long ago during its high noon had thought most rigorously, nor because it was through science that men had gained some insight into the nature of the physical world, but rather because the application of scientific principles had revolutionized their MATERIAL CIRCUMSTANCES . . . Inventive scientific intelligence still exercised itself brilliantly in improving the technique of industry, and thus completely dominated the imagination of a race in which the pure intellectual curiosity had waned. The scientist was regarded as an embodiment, not merely of knowledge, but of power . . .

The Son of God, in this his Second Coming, had proposed to bring about the millennium by publishing the secret of divine power, but finding the peoples still unable to put into practice even the more primitive gospel of love which was announced at his First Coming, suffered martyrdom for man's sake, and entrusted his secret to the scientists.

Science itself, the actual corpus of natural knowledge, had by now become so complex that only a tiny fraction of it could be mastered by one brain. Thus students of one branch of science knew practically nothing of the work of others in kindred branches . . . In an earlier period, the sciences had been co-ordinated and criticized philosophically by their own leaders and by the technical philosophers, but philosophy as a rigorous technical discipline no longer existed. *There was of course a vague framework of ideas of assumptions based on science and common to all men, a popular pseudo-science constructed by the journalists from striking phrases current among scientists.*

The material circumstances of the race at this time would have amazed all its predecessors, even those who were in the true sense far more civilized. *But to*

us, the Last Men, there is an extreme pathos and even comicality in this most thorough confusion of material development with civilization . . .

All the continents, indeed, were by now minutely artificialized. Save for the many wild reserves which were cherished as museums and playgrounds, not a square mile of territory was left in a natural state. Nor was there any longer a distinction between agriculture and industrial areas . . .

In spite of this material prosperity, man was a slave . . . for the all-pervading idea which tyrannized over the race was the fanatical worship of movement . . . From childhood to death, the individual's conduct was determined by the obligation to produce as much motion as possible, whether by his own muscular activity, or by the control of natural forces."

Last and First Men by Olaf Stapledon
Dover Publications, Inc.

Living phenomena are indeed intelligible in physical terms. And although much remains to be learned and understood, and the details of many processes remain elusive, those engaged in such studies hold no doubt that answers will be forthcoming in the reasonably near future. Indeed only two truly major questions remain enshrouded in a cloak of not quite fathomable mystery:

(1) *THE ORIGIN OF LIFE*, i.e. the events that first gave rise to the remarkable cooperative functioning of nucleic acids and proteins which constitutes the genetic apparatus, and (2) *THE MIND-BODY PROBLEM*, i.e. the physical basis for self-awareness and personality. *Great strides have been made in the approaches to both these problems as summarized in Chapters 6 and 9, but the ultimate explanations are perceived very dimly indeed."*

Biology and the Future of Man edited by Philip Handler
Oxford University Press

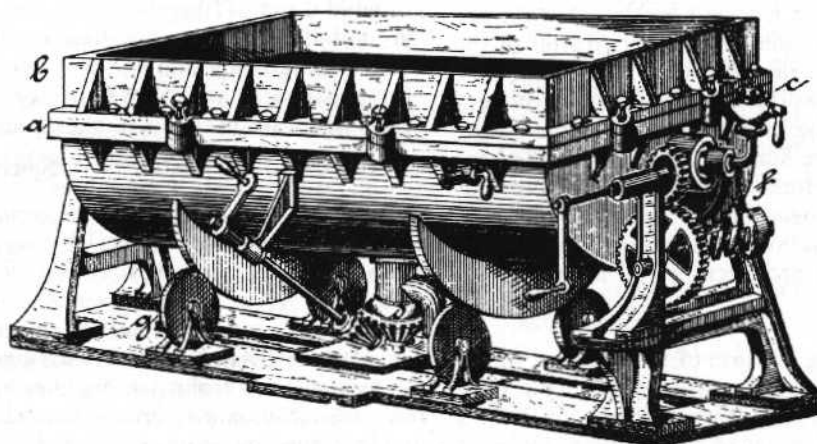

I, ROBUR MASTER OF THE WORLD

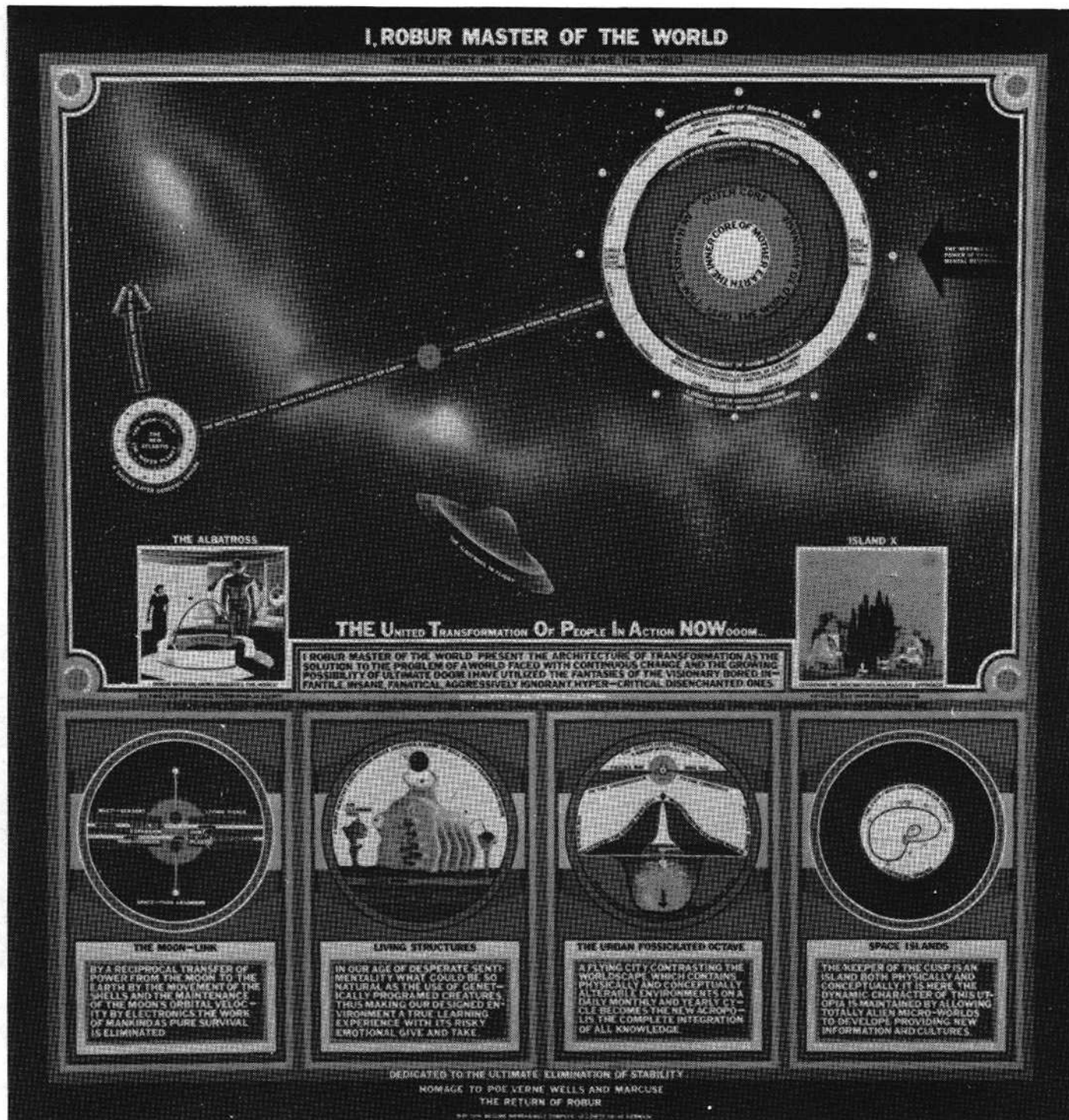

... I was wondering if it would be possible to make mention of my painting called "I Robur Master of the World" which I painted in 1968. It is an attempt at a wholistic design for the world, utilizing double layer geodesic spheres surrounding both the earth and the moon, at about 5 miles off the surface, which are linked together through space to form a gigantic motor. I included slow exploding hydrogen bombs for local energy, a flying saucer transformation architecture city—a new acropolis—actual living architecture and attendant devices.

I refer to this painting because of its reference to the Klein surface and living structures which you have shown interest in ... I tried unsuccessfully to build a Klein bottle house that I designed back in 1964. I wanted

to build it out of fiberglass and have it floating off of the ground 10ft. by using repelling electromagnets, but the whole thing being almost 90 ft. long etc., and the cost being estimated at \$250,000 or more to build, it was impossible for me at the time, but some day I will.

36 Bromfield St., Boston Sincerely, Paul Laffoley

The Boston Visionary Cell is proud to announce the formation of the New York Visionary Cell at 340 East Sixth St., N.Y.C. The New York Cell will attempt to act as a nexus for all artists, scientists, musicians, writers, philosophers, etc. who feel the mystical union of the forces of the Universe ... Discussions in Mind Physics, the formation of group personalities by telepathy and astral projection, and reference material on visionary art and literature are being established.

Telepa-Vision

It is often the inventions of which we are most proud that are precisely the things most inhibiting our function and preventing us from further growth and the gaining of meaningful insight into our condition.

The invention of language has frequently been credited with being the beginning of human civilization. What is left unsaid is that the *necessity* to invent a "meaningful" means of communication reveals the most critical limitation of our biological structure in its adaptation to our environmental situation. Language has done very little toward removing that limitation.

In order to have balanced communication in respect to both our internal mechanisms and those of our environment, we must be able to communicate at the same rate that we need, receive, process and produce information; and in forms analogous to the nature of the raw information we receive and the forms by which we process it.

Our processing capacity can be assumed to be greater than our information inputs, at least in relation to the redundancy of the information which now makes up our inputs, or we would experience overload even without simulsensory experience. Its capacity in terms of different kinds of information processing and learned procedures and stimulation is probably considerably above what we experience today in our low information-intensive environment.

Today, for the first time in our history we are on the threshold of having the capabilities to make a huge leap in our communication ability. The primitive devices which we already have, such as television and photography have made a quantum jump over speech and writing in that they are optically receiveable, rapidly transmittable and are non-linear in nature, higher rate of data extraction from our raw information. They still have a basic drawback in mostly requiring environmental image sources with their problems of availability and accessibility. A cumbersome, second-hand, time-consuming search for conditions and situations which give images close to our thoughts does not give our thought-images, and does not permit the open uninhibited flows of information necessary to balanced communication.

We know that on the operative level our brains process great quantities of information through visual images, and that visual and spatial forms are as integral a part of mental and psychic structure of our universe as of its material and energetic structure. Yet, we have not sought means to make these mental images directly communicable. Development of ways to tap into our mental images and communicate them can offer up to a ten-fold increase in our communication capacity and an order of magnitude increase in its effectiveness. The ability to communicate directly and effectively between minds will begin opening the pathway towards integrating man into an operative super-organism which is now blocked by the difficulty and low relative speed of communication. The telepathetic link-up of our minds can



by Tom Bender

begin to move our information handling capacities by several orders of magnitude towards the theoretical potentials promised by information theory.

Some of this development may be most effectively achieved through breakthroughs in telepathy and conscious access to brain wave control now being made, though there is no way of knowing today how much this will be dependent upon external mechanisms. Preliminary work in Alpha-wave control and the studies on time by N.A. Kozyrev can give an inkling of possibilities in those areas. Many essential questions on brain function remain today unanswered, though being studied. Yet an operative form of telepa-vision can undoubtedly be created today through application of present communications and information technology.

It is important that we begin to think in terms of equipping man with TOOLS with which he can more effectively reach toward his dreams, rather than of replacing man by MACHINES which in isolated measure are more efficient than he, but which lack the integrative power of life and the complex stabilizing and balancing mechanisms of natural systems.



Marjorie Kawin-Toomin

Western man is growing increasingly concerned with exploring, understanding, and controlling his inner world. His search is leading to paths which unite the science of the west with the mysticism of the east. These paths include the knowledge that man's physical and mental states are inseparable; that man can, by his will control all aspects of his being including those previously thought to be "involuntary." Conscious control of these functions may be acquired if immediate bio-feedback is available.

There are frequent reports in the literature that an increase in alpha productions is generally found in meditative states . . . These brain wave patterns become stronger with the years spent in Zen training and parallel the degree of the Zen disciple's mental states. Zen meditation (or any for that matter) involves "concentration without tension" in the inner mind. . . .

There is wide agreement on the research literature reviewed that the alpha rhythm represents

some kind of synchrony in the firing of neurons in the cerebral cortex in the area around which the electrodes are placed. Eleanor Criswell (1969) speculates that "if we reduce cortical activity and still the mind, we are allowing more primitive brain structures to have more free play . . . more unification." Deikman (1963, 1966) use the term 'automization' to describe what seems to be a process of brain synchrony. He suggests that clearing the mind of its habitual patterns of perceiving and thinking leave it free to take in information in a fresh manner possibly to re-process cognitive and sensory stimuli in new and creative ways.

Empirical evidence to support the above theoretical assumption comes from the similarities involved in meditation exercises and alpha training procedures. Both limit the subject's perceptual field, reduce stimuli entering the brain particularly cognitive content), focus on repetitive tasks and encourage passive awareness of internal and external events. With this "stilling of the mind" comes synchronous firing of cortical neurons. When the

subject engages in active processing of stimuli (thoughts, feelings, perceptions) goal-oriented attitudes and energetic problem solving activities, desynchronization occurs. The alpha rhythm is blocked and other patterns—most often high frequency, low amplitude beta waves—predominate. Stilling the mind to the point of no longer attending, even passively, is accompanied by the drowsiness of the low frequency theta waves and eventually the delta waves of sleep.

The first way in which to use alpha control is to enjoy it. The alpha state is pleasant, relaxed and rewarding to experience. Learning to know and control parts of one's being previously mysterious and apparently involuntary, is exciting. With feedback, individuals are able to discriminate the kind of thoughts, feelings and attitudes which represent an easy flowing with the environment and with their inner selves (the synchrony of the brain). It is possible to learn to function at this level more often, thus generally making life more comfortable.

The possibility of using alpha control to reach "altered states of consciousness" is an exciting one. Alpha is a normal brain pattern. To manipulate alpha is only to alter the occurrence of a natural state. This, apparently, is one of the things meditators do after years of training. The voluntary control of thoughts, feelings, attitudes, and body states associated with meditation may be more efficiently and more quickly acquired by the use of an alpha feedback device such as the Toomin Alpha Pacer. Both meditation and alpha production require passive attention, physical relaxation, and a feeling of flowing with both the inner and outer world.

It is tempting, but perhaps naive, to think that because high alpha amplitude and marked changes in frequency into the slow alpha or theta ranges are typical patterns produced by experienced meditators, that training such patterns by the quicker, easier bio-feedback methods will provide the same total subjective experience.

The Tooming Alpha Pacer has been found to be a particularly useful device for those who wish to facilitate their progress in meditation. The tone of the Toomin Alpha Pacer may be used as an effective mantra. The sound is pleasing and repetitive, and its presence or absence allows the meditator to know immediately "where he is." The calibration of both amplitude and frequency of alpha and theta activity is a unique feature of this instrument. In the Toomin Laboratories, two experienced meditators with well-established high amplitude alpha rhythm were able to raise and lower the frequency of their brain waves in a matter of moments by following the pacing device on the Toomin Alpha Pacer. They experienced excitement, a feeling of well-being, a sense of one-ness with the universe and great joy as they moved into higher alpha frequencies—up to 12 Hz.

This is excerpted from a pamphlet distributed by Toomin Laboratories, Inc., 41 W. 71st St., N.Y.C. 10023, which accounts for the product bias. There are many people making alpha wave detectors, some of which are listed in the Last Whole Earth Catalogue.

We've talked to Adam Crane of Toomin Labs., and he says that a good Alpha Theta wave pacer costs between \$150 and \$275 at the least. He claims the cheaper ones aren't accurate nor do they incorporate the variable controls necessary to really use the machine for increasing mental control. We tried their pacer (\$275) and it worked well but we're still not convinced that the yoga discipline can be replaced by a machine feedback system. Also the price seems a little high but maybe you pay for what you get (or is it the other way around).

vital sign integration

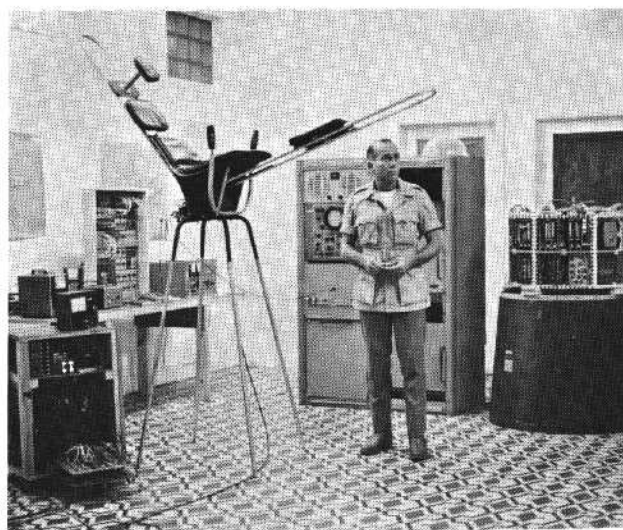

By John Sowaal

This Vital Sign Intergration System permits an interacting traveler to focus attention on four vital signs as they reflect feedback changes. It was developed as a subsystem for the Comfort Maze and certain of its characteristics will be used in later models of the Maze as well as in a new system that is still in the planning stage.

Most of the biofeedback experiments we hear about adopt a closed form design for all systems even when the system has manifest open form properties. This kind of thinking goes well with the objectives of conditioning as behaviorist use the term. The alpha rhythm fade exemplifies the mode. Generally the claims you hear suggest direct access to a rosy state of consciousness. Descriptions of alpha control then link up with tales of Zen and Yoga and the whole business begins to sound like another capsule relief, a murti-bing or soma trip.

If you can excuse the unguarded moments of professional experimenters while describing their projects or the aims of hungry pilgrims looking to buy some real estate in their own minds—then no one is to blame. But the tasks that lie ahead in merely mapping human feedback systems make all the jazz about alpha control into another leaky promise. The significance of living feedback systems derives from an interrelatedness with other systems. Even the exquisite control of a subset of systems fails to provide anything close to clean information about the total organism.



PROG. 61

MCH-PR 70

MANFRED MOHR COMPUTER GRAPHICS

Accepting that creative work is an algorithm which represents a human behavior in a given situation, it is natural to ask: how is such an algorithm built up, and which precise mathematical laws could be extracted for later use in different circumstances? If one is now curious enough to look for his own aesthetical parameters, he is ready to engage in an interesting line of research. These considerations led me to use the computer as a **PARTNER** in my work.

The first step in that direction was an extended analysis of my own paintings and drawings from the last ten years. It resulted in a surprisingly large amount of regularities, determined of course by my particular aesthetical sense, through which I was able to establish a number of basic elements that amounted to a rudimentary syntax. After representing these basic constructions

through a mathematical formalism, and setting them up in an abstract combinatorial framework, I was in a position to realise all possible representations of my algorithms.

Since the most important point in applying a computer to solve aesthetical problems is the **MATERIALGERECHTE** use of this instrument, the research therefore should assume that old techniques of drawing and imagination are not to be imposed on the machine (although this would be possible), but should develop a priori a vocabulary which integrates the computer into the aesthetical system.

Computer graphics in general are conditioned by four basic premises:

1. A **PRECISE** idea of an aesthetical problem.
2. The need to break this idea into parts which could be reassembled as a program.

3. A steady control of the computing process to take full advantage of the **MACHINE — HUMAN** dialogue.

4. The need for the logic of the events to become perceptible.

The logic built into a program makes it possible to create a nearly infinite number of new situations. This is very important since the creation of a form is limited a priori by its author's characteristics, of which he may be conscious or unconscious. It means that the exploration of a new idea leads sooner or later to a repetition which can be avoided by resorting to a computer once the basic parameters have been formulated. As it is possible to conceive the logic of a construction but not all its consequences it is nearly an imperative to rely on a computer to show this large variety of possibilities; a proce-

dure which may lead to different and perhaps more interesting answers, lying of course outside of normal behavior but not outside of the imposed logic.

At this point a new problem appears: how to choose what is to be kept and what is to be rejected?

My aesthetic criteria were determined by a decision not to create single forms but sets of forms. The basic parameters are the relationships between the forms and no aesthetic value is associated to particular forms. Within this context it is possible to ignore the former "good" and "bad", and aesthetic decisions can be based on WERTFREIE** procedures, where the totality represents a "quality of a quantity". The fundamental consequence of this attitude is, that after a period of tests, modifica-

tions of the logic, and parameter exchanges, all possible results of a program have to be rigorously accepted as final answers.

Computer graphics is a young and new way of aesthetic communication; it integrates human thinking, mechanical handling, logic, new possibilities of drawing, and incorruptible precision of drawing — a new DUKTUS!***

The concentration which is necessary to establish a logic (writing a program — that means to give a definition of all instructions that have to be done in the machine) will reflect itself in the result as a clear construction which could be understood by everybody and there will be less and less mystical barriers behind which the artist can hide himself.

Manfred Mohr

* MATERIALGERECHT, German for: working or using a material only in the way which is basic to the material.

** WERTFREI, German for: decisions, where the knowledge is neither based nor conditioned by any values.

*** DUKTUS, Lat., German for: "handwriting". Individual peculiarity of the drawing material.

Signed, limited edition three-color silkscreens of the work of Manfred Mohr and other computer artists are available from: Gilles Gheerbrant, 3355 Queen Mary, Montreal 247, Quebec, Canada.

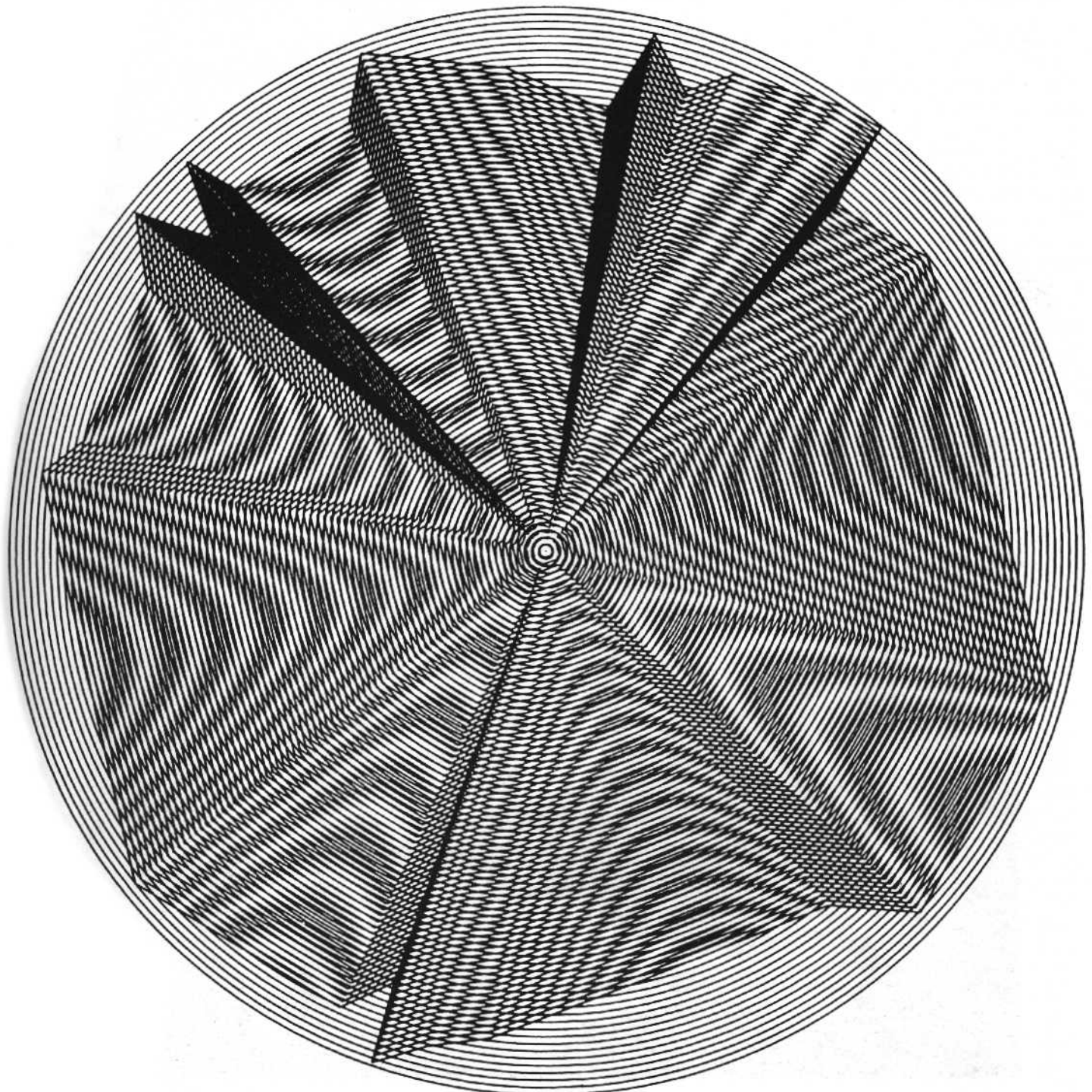

VIDEO SOMA FEEDBACK

By Merrily Paskal

Imagine.

You can have a videotaperecorder at home. You can record sound and image and play them back right away. You can even monitor as you are recording. What do you do?

Strip.

Make Love.

Mastrubate.

Wave your cock.

Grin happily and idiotically at all the taboos you are so joyously flaunting.

We are not supposed to dwell on our own bodies. And yet we all, for the extent of our sojourns on earth, live in a body, mostly our own, sometimes fused with another. We *are* interested in our bodies. We have had enough of undressing in the dark. In this culture we are starved for soma-feedback.

"Tape is a tender way of getting in touch with oneself. In privacy, with control over the process, one can learn to accept the extension out there on tape as part of self. There is the possibility of taking the extending back in

and reprocessing it over and over again on one's personal time warp." Paul Ryan

When we begin to relate nude to ourselves on tape, we imitate porno movies. Most couples set the camera on the tripod and point it at the bed. They press the record trigger, hop on the bed and screw. They do not watch themselves as they are screwing but they get off on the fact that they are making a dirty movie. Then they play it back later and if they have the energy they start again. Same movie. It is an elementary form of delayed feedback but it is after all our only model for nude behavior in front of a recording device.

But we *have* developed new modes of behavior and we can discover ways to feedback on that behavior and reinforce it. How ironic that we reprocess our love in their package.

"Narcissus gazes stupified, paralyzed, at his image in the pool. His image is cut off from him and the amputation produces a numbness and closure that make it impossible for him to recognize his extended self. As long as we accept the Narcissus attitude of regarding the extensions of our bodies as really out there, really independent of us, we will meet all technological challenge with the same sort of banana skin pirouette and collapse." Paul Ryan



photo: Dudley

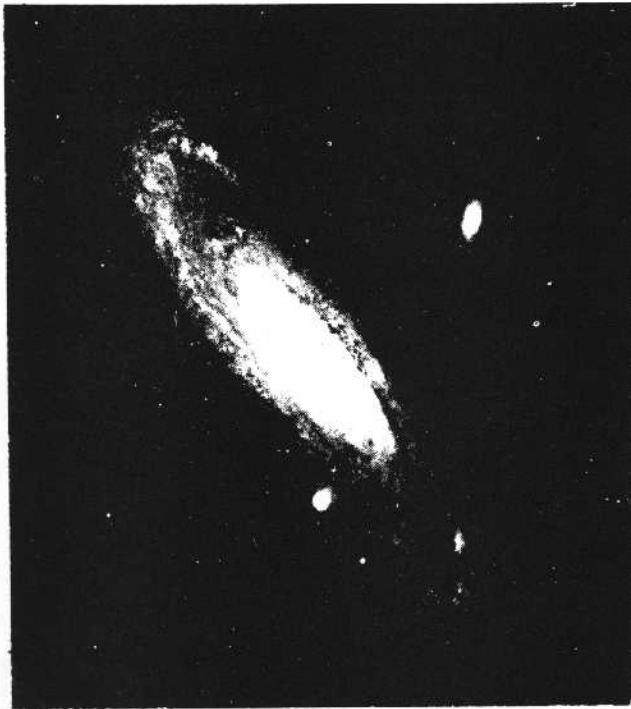

One way to retrain our frizzled senses is to do all soma-feedback with an RF adaptor and interact with our image as we are generating it. The connection between you and the screen is so startling, so clear, if you watch your movement as you are doing it, than you cannot fail to respond to yourself.

You can do this with a static camera or you can work with someone close to you who will hold the camera, a slow examination of your body on video is a good way to start. The idea is for the camera to pick up on your cues. You may begin by telling—"show me my breast and my arm". With practice, you will be able to work together without words.

You might get into it by having the camera pick up a section of your body—say, arm and side. Look at the monitor (the cameraman will be getting his feedback through the viewfinder). The screen is the canvas on which you paint with your body. Move your arm against your side, twist your body, move your hand up to touch along your side, study and sculpt with other parts of you. Dance, shake, make graphic shapes, make rhythms, watch the screen—the screen is part of you, an empathic projection.

Each feedback trip is different. Some are yoga-like. Some are pulsing and physical. Some are playful. Some never happen, never get off the ego and into the interaction.

When you know you, do the soma-feedback with someone else. I have never done couple-soma-feedback with a static camera but if you can't find someone you trust to work the camera, start that way. If you have someone close to work the camera and *if both partners accept the qualification* of exploring the feedback possibilities and not imitating porno format, you will share a beautiful erotic experience—long, sensual and stimulating. For some it is difficult to relate to the video and also to each other. I saw a tape with one solution to the problem. A man and a woman were in separate rooms,

each with a camera and monitor. They were connected by a control room. They related to each other a split screen, in superimpositions, in various wipes and cuddling, kissing, licking, posturing, *long distance*—they built to a crescendo of lust until they broke into each other's rooms. The video connection allowed them to act out fantasies and interact sexually in ways that they would have been inhibited to do face to face.

Soma-feedback is fun not only in couples, but with friends and kids. With friends, you touch, play, make some forms, enjoy a creative time together. With kids, you will romp through the feedback trip—nudge, wrestle, stack up on each other, back to back, arm to arm, compare shapes, make sculptures of arms and legs.

Video interaction with other people is a tactic for avoiding both servomechanistic closure and desensitization in using videotape. It is best to avoid inhibiting word labels on what you are doing. Forget my headings. "Exuberance is Beauty . . . the cistern contains, the fountain overflows." To overflow one need be infolding. The process of infolding cannot be frozen in words. Let go the formulations and take another trip where your inside is out and your outside is in.

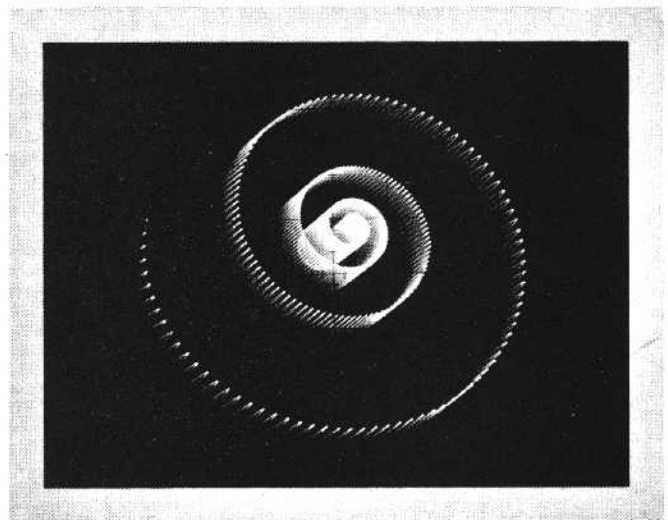

78 More Chances to Survive

From a media savage on the primitive island of Pittsburgh located near 3 rivers in the middle of the steel waste land of Pennsylvania. Also reprint of old scroll found in an abandon coal mine once rumored to be Andrew Carnegie's next rip-off stunt. Note: nothing is mentioned of media evolution suspect capitalist are taking advantage of good thing. Urgent . . . supplies for the winter are running out must get "feedback" for survival in media space. Local stations are rotting local villagers minds. Becoming increasingly difficult to maintain contact. Must leave now going back to my media cave and plan more subversive activities.

Piltdown media culture
Willard Van De Bogart
Media Man

Attitudes Toward Technology

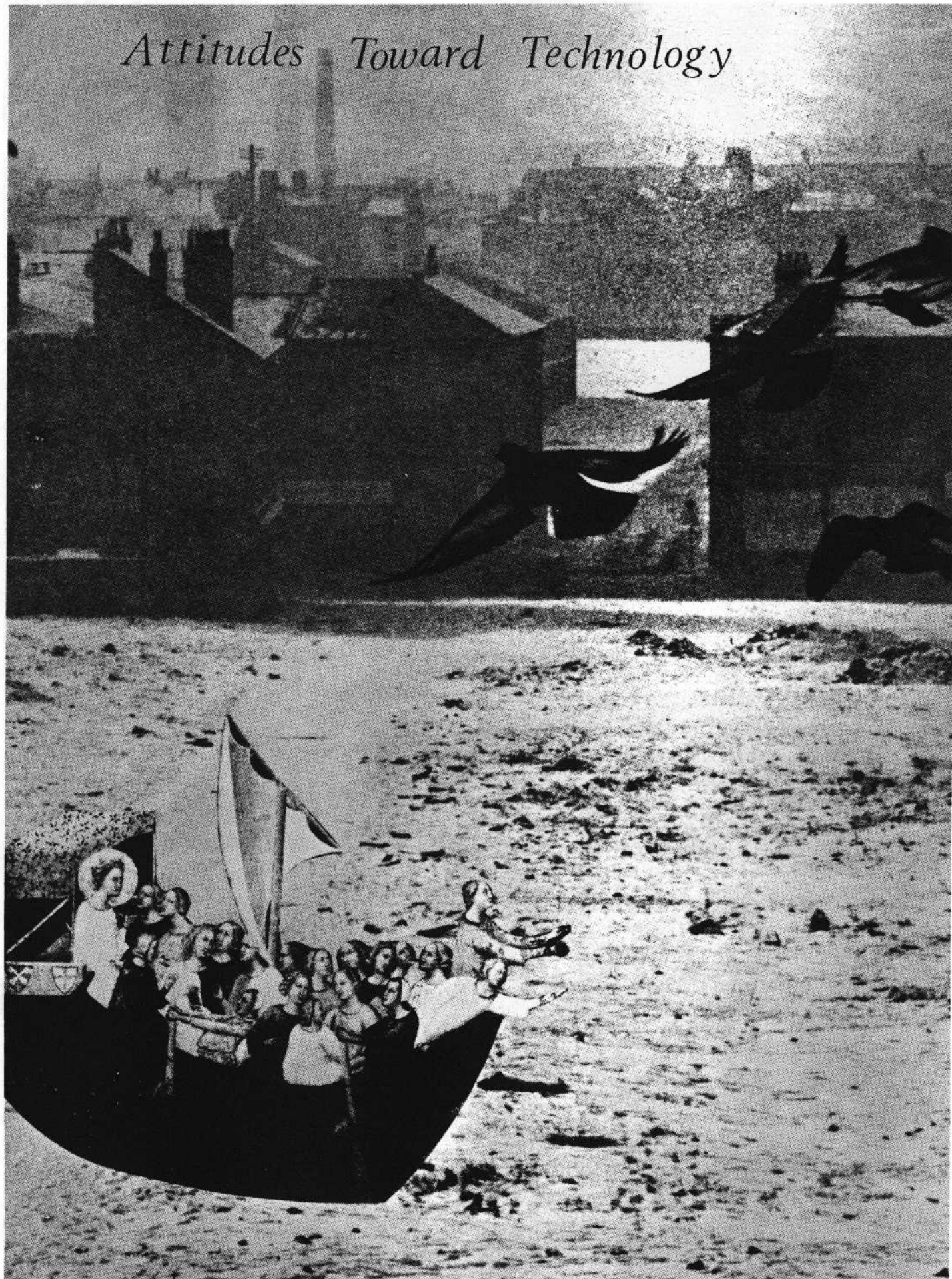

collage: Jodie Sibert

I'd like to sketch out some attitudes toward technology which I personally prefer. These aren't the only attitudes possible. Nor are they the only ones I'm likely, eventually, to prefer myself. They're just attitudes.

Some will find these attitudes naive, arguing that the development of technology has its own logic to which we must adapt. Others will find these attitudes dangerous, arguing that technology is, definitionally, bad for man, nature and society and that it must therefore be destroyed. Some will recognize that these attitudes are an initial attempt to see technology as our servant and the servant of the environment.

The first attitude toward technology is that it is the creature of man. Man makes technology. Therefore, it makes sense to say that man can control it. The truth of the Frankenstein myth—the myth of technology taking matters into its own hands and eliminating human control—is that the people who created the monster allowed (or intended) it to get beyond their control.

The second attitude toward technology is that man can do with it whatever he wants. Technology is the same as magic. This means that the only significant question regarding technology is, *what should be done*. Showing that something *can* be done is, definitionally, an irrelevant activity.

Like the Sabbath, technology is made for man; man is not made for technology.

The third attitude toward technology is that it should function invisibly. What is important about a machine is *what* it does. *That* it does something is irrelevant. Our tendency to place technology in places where it can be highly visible derives from the attitude that one should prove that one *can* do something. This attitude involves a lack of self-confidence.

An analogy with the human body is useful here. We tend to flaunt our achievements by exposing them to view: phone lines. Imagine if the brain wanted to flaunt its abilities by stringing brain cells around the outside of our skulls.

Technology should be invisible, recessed. This reality is signaled by the phrase, technological infrastructure.

The fourth attitude toward technology is that it should develop in the direction of "doing more with less". Thus unless other considerations should take precedence, technology should develop in the directions of:

miniaturization
speed
low heat production
low energy consumption
zero waste production
multi-channel control capabilities
multi-environmental compatibility
zone organization (i.e. systems which organize progressively large hunks of reality; this goal is only possible through miniaturization.)

The fifth attitude toward technology is that both the form and the function of technology must be "beautiful" in every respect. Not sanitized like an IBM office, but beautiful and warm. The machine itself and the thing it does must be optimally esthetically pleasing to those who are associated with it. A technology which degrades people and the environment is, definitionally, bad. The idea that we can use an unattractive and degrading technology (e.g. a factory or an office building) to manufacture a pleasing product is nonsense. A beautiful environment is the minimum requirement, not the idealized goal.

The sixth attitude toward technology is that it can be changed and improved. If a piece of technology is not doing what people want it to do, they must find a way to change it or build another piece which does what they want. It is unreasonable to say that any piece of technology is "as good as we can get it". Technology is fully and fundamentally mutable. The development of technology is an infinite pro/regress.

The seventh attitude toward technology is that technology is necessary. The relevant questions regarding technology are whether, what, when, should and will.

The eighth attitude toward technology is that, like magic, it is a quick-sand. In fact, there is no fundamental difference between using technology for "beneficial purposes" and using it for "other" purposes. We need not to do away with technology but to get beyond it. Beyond technology we do not get into hassles like "good" and "bad" technology. In a sense, we get beyond much of what has been said in the previous three pages.

The most fundamental attitude toward technology, therefore, is that it *IS* magic.

The metaconcept behind that statement is that thinking is technology. It is the idea in one's mind which is real and the hardware is merely a realization or manifestation of sets of ideas.

DEFINITION: *technology is thinking is technology is magic*



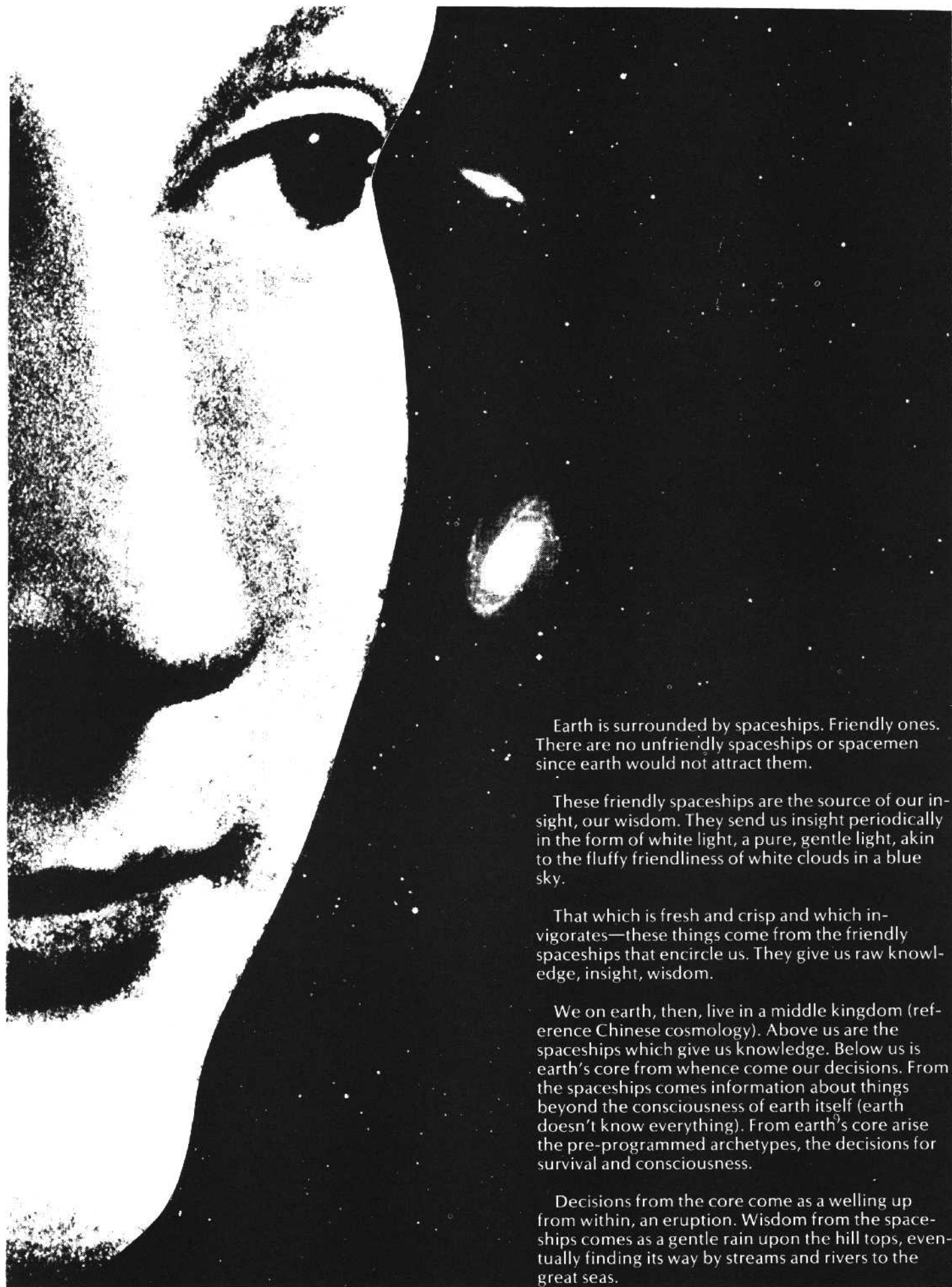

Earth is surrounded by spaceships. Friendly ones. There are no unfriendly spaceships or spacemen since earth would not attract them.

These friendly spaceships are the source of our insight, our wisdom. They send us insight periodically in the form of white light, a pure, gentle light, akin to the fluffy friendliness of white clouds in a blue sky.

That which is fresh and crisp and which invigorates—these things come from the friendly spaceships that encircle us. They give us raw knowledge, insight, wisdom.

We on earth, then, live in a middle kingdom (reference Chinese cosmology). Above us are the spaceships which give us knowledge. Below us is earth's core from whence come our decisions. From the spaceships comes information about things beyond the consciousness of earth itself (earth doesn't know everything). From earth's core arise the pre-programmed archetypes, the decisions for survival and consciousness.

Decisions from the core come as a welling up from within, an eruption. Wisdom from the spaceships comes as a gentle rain upon the hill tops, eventually finding its way by streams and rivers to the great seas.

collage: Jodie Sibert

What calms a man's deepest fears is not the rational but the ritual.

All communication is mediated.

By a screen you place around your partner. You place the same screen around yourself.

The effect is that communication is simply seeing yourself in a mirror. The mirror is the screen you place around your partner.

In communication, you always and only receive exactly those messages you want to receive.

That means you transmit in order to receive your own transmissions.

Transception.

The medium is the message and you are the medium. Always.

As communication begins, there is an instantaneous and simultaneous assessment of compatibilities. Channels over which messages might be exchanged.

From then on, communication is speaking with yourself.

In polytime—
multi-mirroring
multi-communication
multi-self

The issue today is not one of insight or even one of knowledge.

The issue today is one of courage and of strength.

Are you able to withstand the thermal winds of outer space? Without a spacesuit?

Can you pass a spiritual examination before quasars and black holes?

When all your possessions have departed you and you stand naked within an intergalactic radiation storm, will you be able to say, "Yes, I belong here"?

When all of mankind and all of spacékind are your brothers and sisters, when each of them knows you from the first time you masturbated, and when each knows your every fault in detail, will you be able to accept their rejection of you?

When, finally, the bottom drops out of you and you see that you're standing on nothing and hanging from nothing; when, in fact, you finally discover that you're alone and you've been doing all these things TO YOURSELF, will you have courage to say,

"Yes, all my striving has been in vain, I am the source of all error and of all truth, I am always where I belong, I am always doing what I should be doing, I can do no wrong"?

Let me suggest that earth is a sentient being. Earth is a conscious, decision-making, reproducing, goal-oriented being of some considerable intelligence, fortitude and skill. Furthermore, earth is on a life trip. Earth is not about to do itself in.

Let me go a little farther. The core of earth is an information storage and retrieval facility. Earth's brain. Man and his/her intelligence, located on earth's surface, are reflections or manifestations of the information which is stored in earth's core. An analogy here would be with a computer and a CRT (Cathode Ray Tube). Earth's core is like the computer core. Man is like the CRT.

Earth's core is a blue light, making earth blue as a whole.



The functions of earth's core are to:

- (1) store information generated locally and on the surface
- (2) reflect or relay messages between points on the surface
- (3) scramble the coding systems of messages reflecting through the core. (Code scrambling is the means of creativity and self-actualization.)
- (4) gradually, over time, simplify its categories so that all information can be processed by just a few archetypal programs. (We on the surface call this process of simplification "maturing" or "growing up." Religious people call it, getting down, back up or into essences.)

It helps to picture the eruption from within and the rain from without as the two poles of a vertical axis. Then, if we picture East and West as the two poles of a horizontal axis, we find ourselves in a most interesting coordinate system. Teilhard's radial and tangential energy vectors.

In place of schools:

- 1- Build quick-access, poly-media data banks that vary output according to user feedback. User cost: zero.
- 2- Install computer-based programmed learning for all skills compatible with this technique. System should be on-line to any user with a telephone and/or a CRT or typewriter terminal. User cost: zero. User paid for each course completed.
- 3- Generate networks for information describing self-experiences. Any and all experience appropriate. Only it has to be in the first person, singular or plural. Accessible for a minimal fee. Free to those claiming no cash. Use *Whole Earth Catalogue* as initial model.
- 4- Give each individual quick access to software production and distribution systems for each medium currently in use. Means decentralizing and simplifying production and distribution techniques, making systems instantly reprogrammable according to user feedback.
- 5- Be sensitive to the times when a guru calls you. Chances are he or she will find you within but take you outside of most or all of your external technologies, relying instead on earth's meta-electronic systems. When called, GO.

beep . . . beep . . . beep . . .

Long ago, they thought it was a question of oratory. The Greeks and the Romans believe that was how it's done: the spoken word.

Then we invented printing, and this was the Great New Thing.

Then we invented telegraphy and the radio, and very soon we knew we had MEDIA. Video followed, naturally enough, giving us multi-media . . . it could go on, and it probably will go on.

That is not all bad—but each time it happens, some one tells us that the traditional way is obsolete. . . . *that* is what was holding us back. . . . ten years from now, no one will be using *that*: *this* is the only way to communicate effectively.

In our time, some people are showing a tendency to put their hopes in psychic communication. It seems very probably that we are indeed moving in this direction, BUT:

It is all too easy to be fascinated by telepathy, etc., to the relative exclusion of previously known channels of communication that continue to be vital. It is not merely a general sense of balance which is appealed to here, but beyond that, *optimum proportions* in that area where the quantitative meets the qualitative (as in aesthetic considerations, such as the ideal rectangle.)

The most efficient way to convey a message to some one is to use that combination of audio-visual-kinesic-psychic (etc.?) signals to which he or she is most sensitive. Each individual may need a unique combination with regular patterns of proportions. This would be comforting in the sense that there could be no single set of signals which would . . . hypnotize(?) . . . everyone at one time. But it presents a lasting challenge where complex communication between very diverse individuals and groups has to be accomplished.

Be careful of what you want: You just might get it.

The future is half dream, half reality. The reality is the past choices that we have made whose consequences we still must live with. The dream is the countless possibilities that open up as the universe unfolds.

Many people have some ideas about what they expect to happen. Yet few of them stop to think about how their expectations shape the future.

In general, the world does its best to conform to your ideas about it. You can usually find what you are looking for. The reason's simple: the fact that you believe something's going to happen can set up the conditions that assure that it will happen. Self-fulfilling prophecy.

self-fulfilling prophecy operates in many areas. it's easy to alter feedback so that you just see what you want to see. scientists are now finding evidence suggesting that expectations affect things in a way that can be physically measured. both of these are the same thing really—in different areas of the field.

John Lennon: You radiate everything you are.

1. What is the role of projection/radiation/self-fulfilling prophecy in the complex harmonics of a world that must be collectively energized (created)?
2. What ways are there to close the feedback loops to allow people to see the realities they are projecting?

CORECALL NETWORK Towards a community memory

The task before mankind is not an easy one. We've got to build a new culture. The one designed for the agricultural era just isn't in harmony with the reality we're living in anymore.

The work needs to be done quickly—probably in less than one generation. Few cultures have survived basic change. Most have tried to work piecemeal. And cultural schizophrenia—maintained much too long—drained them of life.

One of the keys to culture-building seems to be redundancy. All the different aspects of culture must have elements in common. Institutions as a set of overlapping sets. In this way they can be mutually supportive—synergetic.

CORECALL NETWORK is an idea we've been playing with. We think that it might be able to accelerate discovery of redundancy. A tool for cultural craftsman.

Add some of the operational principles of the human brain.

1) Information can be stored in the brain in a form that can be called "synaesthetic" or "total field". The brain does not record a separate track for audio, video, tactile, etc. inputs. Whole situations are scanned and information from all sources is recorded simultaneously in a single "image."

2) Information at many levels of generalization is stored. . . . routines, programs, metaprograms and beyond.



THE CORECALL recipe:

Start with 1 basic idea.

Redundancy has to do with memory. It starts with, "I've seen this before" and "I'll see it again" completes it. Recall and generalization.

What if we had a system where entire communities had a shared memory—CO-RECALL—and each member of the community could have access to the basic perceptions and ideas of all the other members—CORE-CALL?

3) The brain has many storage areas. There is a wide range in the access available to the various areas. Only a minute fraction of the information stored is immediately (consciously) available.

4) Programs and metaprograms are called from storage by key control symbols (secondary control centers). The key controls are usually elements of the program that are insignificant by themselves. But when they are input, the entire program is called up.



5) Key control symbols can be used singly or in sets. When used in sets they function much like the combinations to locks. Also there may be a threshold trigger on any key control. In this case the symbol will not activate the program until a threshold of intensity (etc.) is reached.

Blend in a couple of new techniques.***

1) A control language that can be used by a wide variety of people working in various media (e.g. print, video, music). This would be a set of categories that people would agree to use—like a library of congress system—for concepts and metaconcepts.

2) A computer programming technique of making “most probably matches” involving sets of overlapping sets. (This particular technique would have many applications. For example, it would make possible computer diagnosis of disease.)

Pour it all into a computer and set up terminals at convenient places all over the community. Put in your input. Output may be seasoned to taste.

And you have CORECALL NETWORK. . . . the most generalized of the new media.

*** Note: The recommended method of growing new techniques is to apply generous amounts of the resources necessary for self-actualization to a group of talented people.

Supplementary Channels

(or)
whatever you would like to call it. . . .

Humanity has seldom, if ever, discovered things in a quick, efficient manner; it seems to be our lot to prove vaguely into the unknown, often getting things incomplete, upside-down and inside-out.

This appears to apply fully to our explorations of ESP to date. Conclusion: we should look for other approaches. One of them appears to lie in the field of wave phenomena at very low frequencies. This is not a statement that adepts will all be able to develop telepathy. Rather, we are beginning to perceive the possibilities of very small particles that cross the spatial boundaries of the cells of all life forms on earth.

In the industrial era, it has been customary to look “up” and to go “up”. Why not look “down”?

. . . . neither kilocycles nor megacycles, just plain cycles. . . .

For example, the possibility that our planet, its surrounding ionosphere, and the space between them could behave as a kind of resonator has been considered by Schumann (Z. Naturforsch. 7a, 150, 1952); his calculations show a fundamental resonant frequency of about 10 Hz (+ cycles per second). Konig checked this out, and found something definite at around 9 Hz, plus a variety of other atmospheric phenomena which gave patterned readings at very low frequencies (Z. angew. Physik 11, 264, 1959).

EEG measurements tell us that there is a great deal of brain activity at very low frequencies. Also, it is known that many live forms (including ourselves) physically perceive and respond to a variety of differences in this range of phenomena (see Gauguelin: “The Cosmic Clocks”, Chapter 8).

EEG measurements tell us something else: that there appear to be specific ranges of recorded brain wave activity, with functional correlations. Here are two versions of the boundaries of these ranges (figures are approximate; neither version is guaranteed to be correct, but both are realistic hypotheses).

RANGE

VERSION I

18 - 23
8 - 13
4 - 7
? - 4

VERSION II

14 - 32
7 - 14
4 - 7
? - 4

(figures are frequencies in Hz)

Look at the vertical columns, from top to bottom: there is a numerical pattern—the boundaries show a tendency to be halved, each step down. A similar pattern occurs in music and acoustics: OCTAVES.

For comparison, here is a lower extension of the tempered music scale (A + 440):

C 0
C-1
C-2
C-3

16.352 - 30.868
8.176 - 15.434
4.083 - 7.717
2.041 - 3.858

(Hz)

Who is going to compose the music of the mind?
. . . . and what will we be able to do with it?

There is a context in which all these things may be relevant—and some of them will probably turn out to be vital. One of our basic, general attributes is the possession of *limited capabilities*, many of which we have managed to extend, for better or for worse. A man who wants to lift a 250-pound rock with his bare hands has a problem: *adding* a suitable hydraulic jack, or winch, to the use of his bodily effort solves the problem, providing he is willing to override nature and take the consequences. It will probably not be long before we have some kind of amplifier or catalyst that will extend our biologically-based psychic abilities. If so, we shall be confronted with a new array of serious questions, for example:

who? (yet another elite class . . . ?)

What happens if we add to earth's existing inventory of infrasonic vibrations and their electromagnetic equivalents?

The writer is collecting information on such topics—readers are invited to contribute comments and any data which might be of interest.

epilogue

I'd like to say a few things about dissolving boundaries and resolving boundaries—we learn by joy and by fear—actually, we learn through both simultaneously, but one is always behind the other—learning through joy is the process of acquiring richer and richer stability for yourself

getting more and more together

you need to be comfortable to learn through joy

the boundaries of your ideas must not dissolve faster or more fully than you deliberately make them dissolve—also, new boundaries must not resolve for you before you're ready for them to resolve

the old theory is that creativity occurs in conditions of extreme stress and imbalance

Van Gogh

Beethoven

Nietzsche

I think we'll find this theory to be partial and misleading

creativity is the process of dissolving and resolving the boundaries you value—comfortably

REARRANGEMENT

Growth

(a new economics)

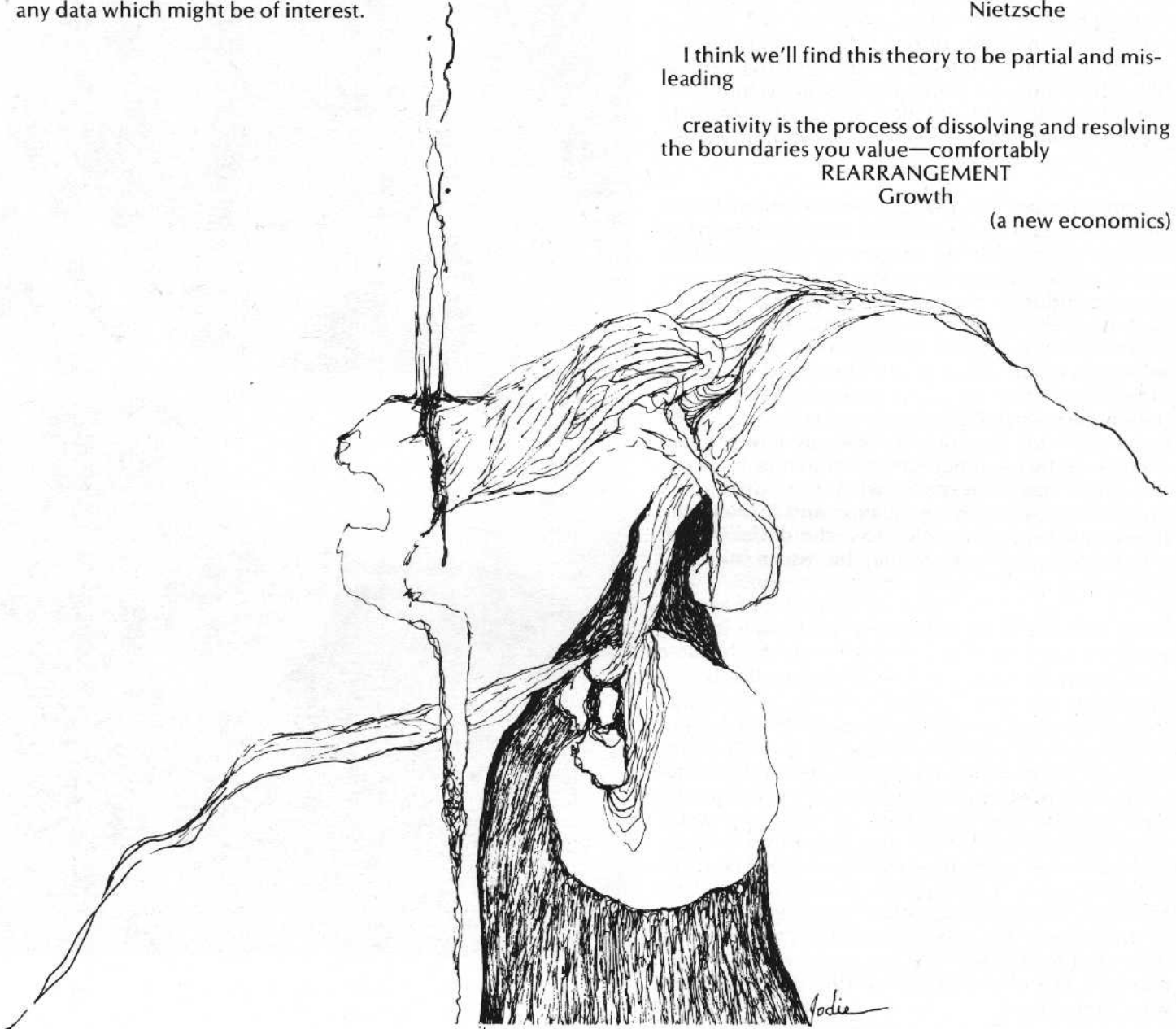

Constructing new life styles

Our evolution is now cultural not biological. It is what is in our heads and how we use this information, not our genetic information, that will be the determining factor of our survival. Cultural evolution requires an informed, literate, and peaceful people. This requires much more than clinics and pamphlets. Huge injections of many kinds of supplies will be required. This is only possible if the world recognizes the state of emergency that exists now.

Economic thinking has come to focus on monetary growth which has pushed all other factors to the periphery of our management decisions. Many are blaming technology and science for today's environmental problems and alienation; but science would not have been "misapplied" if our economic institution were knowledgeable and holistic. To promote the general welfare, economics (household management) must derive from ecology. Such a major reorganization of our affairs will require an unprecedented period of rapid cultural transformation. This requires a general consensus as to the nature of our present situation and a willingness to recognize our dependence on a life support system that is finite.

Some groups still perceive environmental concern as a means to an end such as overthrowing or scoring revenge on all or part of the "establishment". Others simply see it as a movement to force a long overdue cleanup of smoke, smells, and spills. Such positions are not only naive, but are making an adequately clear understanding of the ecological perspective difficult to grasp. The advocate system of settling a dispute in court or justifying a revolt in the streets is an archaic mechanism in the face of the task before us. Everyone is adversely effected and threatened by the inequities generated by a culture that does not understand what it is dependent upon. Only by massive education and through defining new values by which to make decisions and transform our institutions may we assure ourselves of a future.

We now use more energy every day than is available to us from the sun. Not only have we become dependent on finite fossil fuels and are becoming dependent on finite nuclear fuels. There is no way that we can survive such an inequity. We have also restricted our usage of solar energy. We have contaminated the upper atmosphere resulting in the increased reflectance of the earth's atmosphere. This loss has been amplified by increased water vapor at lower levels from irrigation and reservoirs. In addition we have increased the non-utilization of the sunshine that reaches the earth's surface. We have cleared away oxygen producers, green plants, to make room for oxygen consumers, people and their attendant cars, factories, roads, etc. We have also lost agricultural lands to urban sprawl, highways, and airports.

Every animal requires a certain type of dwelling place to protect himself from predators or to moderate the conditions of the environment in which he lives. Man's household is becoming increasingly hostile to him. A continuum exists from a rural house in a non-industrialized country to an apartment in a large industrialized city. It is ironic that western cities are choking and befouling themselves on materials gathered from impoverished regions of the planet.

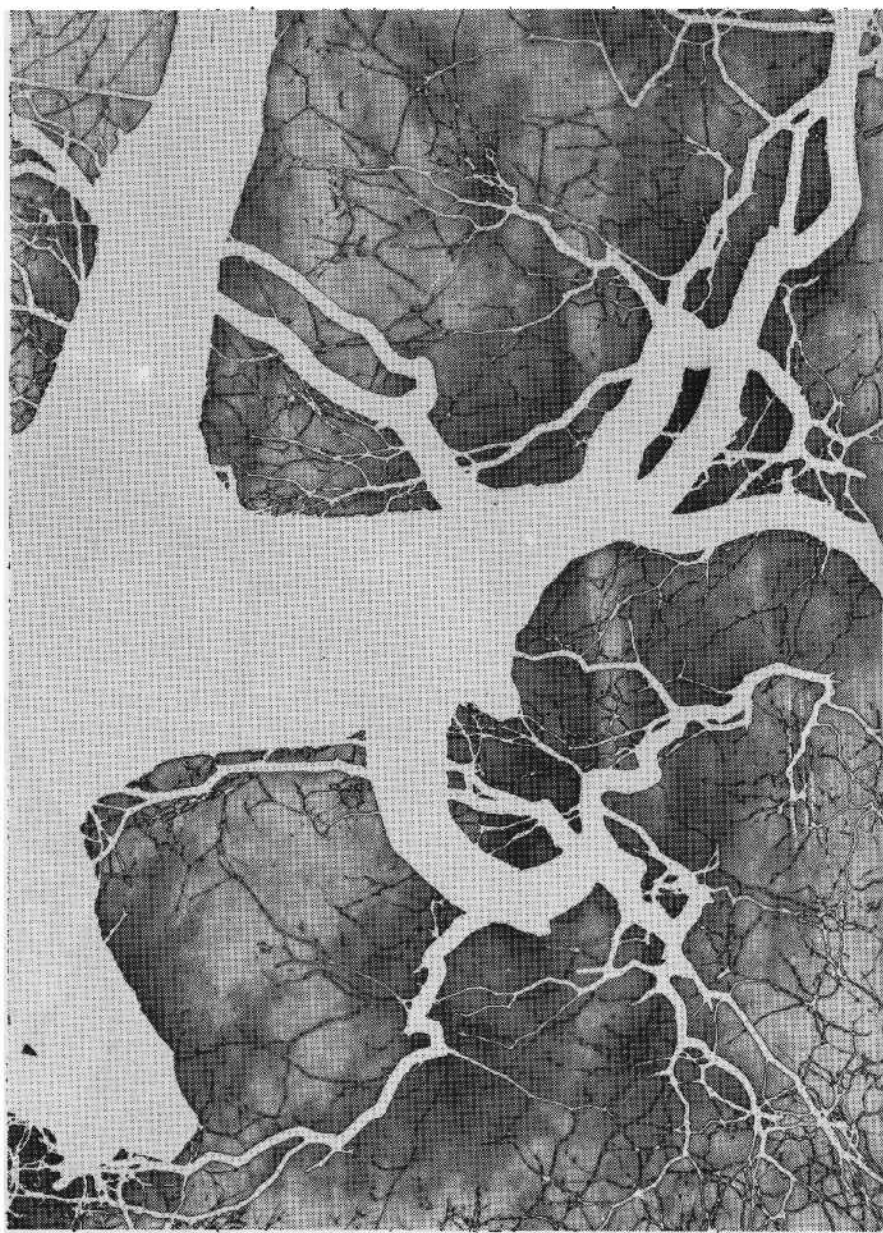
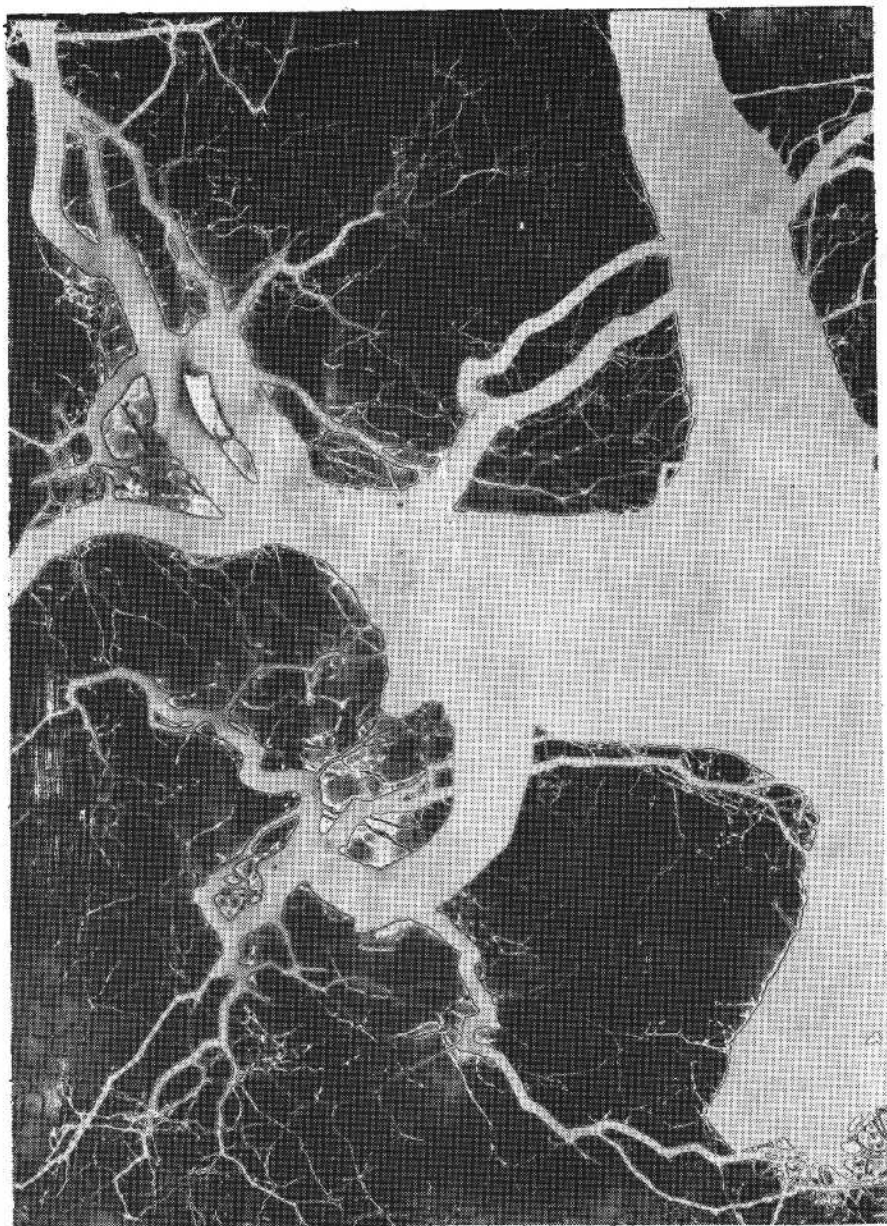

photo: Russell Dian

from an ecological perspective

The task before us, bringing our activities into tune with our needs and the earth's limitations, in itself requires energy. Remaining fuels should be mostly used for these tasks. As fuels are consumed in ignorance of this perspective, options are surrendered. Another consideration is how much fuel should we keep in reserve to meet unknown contingencies of unknown magnitude? Fossil fuels will perhaps offer alternatives under such conditions that future energy sources might not be capable of offering.



Our resource base must switch from new materials to the reuse of spent materials wherever possible. It must be understood that man hours are a renewable resource that should be utilized to the fullest in order to conserve the non-renewable resources. Unless we return organics to the soils, we will have no crops in the future. Obviously the economics of supply and demand in the market place have not reflected all the costs of production, use, and disposal.

The stability of the life process and the moderation or consistency of physical conditions on the planet is achieved through two avenues, homostatic mechanisms and organic diversity. Homostatic mechanisms control temperature, rainfall and other conditions. Stability of the life process within any of the planet's communities is provided by organic diversity. That is, a wide variety of characteristics in a community assures that nothing will get out of control or that one disaster will not destroy the entire community.

*Excerpts from an article by Clifford Humphrey,
Ecology Actional Educational Institute*

"In the new society, the existence of technology means that man's great goal must be consciousness . . . and consciousness is a very different thing than material goods of their equivalents, honor and status. These by their nature are in short supply. But consciousness, or to use an old expression, wisdom, is not a substance that is subject to upward limit. In seeking wisdom, men's interests are not antagonistic. No person's gain in wisdom is diminished by anyone else's gain. Wisdom is the commodity that is unlimited in supply. Indeed, each man, his experiences, his personality, his uniqueness, becomes an asset to other men when their object is to gain in wisdom. The more unique a person is, the more he contributes to the wisdom of others. Such a community makes possible and fosters that ultimate quest for wisdom—the search for self. Each person is respected for his own absolute human worth. No such luxury was possible during most of man's history. It is wealth and technology that have now make community and self possible.

In a community devoted to the search for wisdom, the true relationship between people is that all are students and all are teachers. Teaching in this sense consists of helping each person with his own personal search for experience and his own goals. Although the goals are individual, it is apparent that the search for self cannot take place in isolation, that self must be realized in a community, and therefore the community enhances each person no matter what his particular endeavor."

The Greening of America by Charles A. Reich
Bantam Books

This story is about the end of the world

by Ross Gelbspan

The end will come within the next 100 years, under the weight of population and industrial over-growth, according to a team of MIT scientists, unless we stop all growth within the next few years. Otherwise civilization will collapse

PROJECTION FOR DISASTER

Adapted from computer-output chart in "The Limits to Growth" report

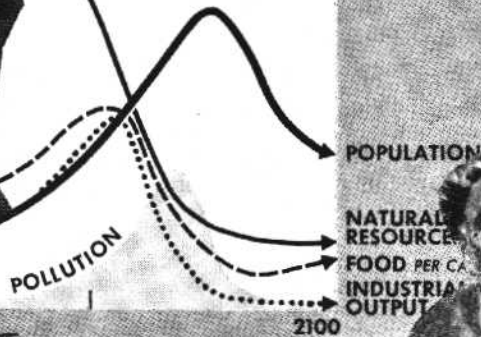

nger, pollution, aps 100 other terrifying accompany the ion.

The end of the world

Continued from page 1

age of the whole in constant time periods.

The end of the world

Continued from page 72

Merely to control one of two of the factors—by, for example, pollution and birth control—would not alter the inherent process of exponential growth which is leading us very quickly to the point Meadows calls "overshoot"

The equilibrium state goes against a fundamental American instinct—the drive for growth. The changes that will be required in our mentality are staggering. It means we must be willing to give away much of what we have. It means the whole world would be living at about the same standard of living—approximately that of middle-class Europeans—if we act quickly. It means that people will probably be working only a scant portion of the hours they now work. It means a tremendous shift of capital from material and industrial goods into service areas—education, health, the arts, sports, etc.—which do not yield increasing capital dividends. It means the end of the marketplace economy, the equalization of wealth throughout the world. It means a totally new global consciousness which is as remote from the mainstream of American thought as Copernicus' conception of the universe was from the church-dominated mentality of his time. Only we have a very few years to make the adjustment.

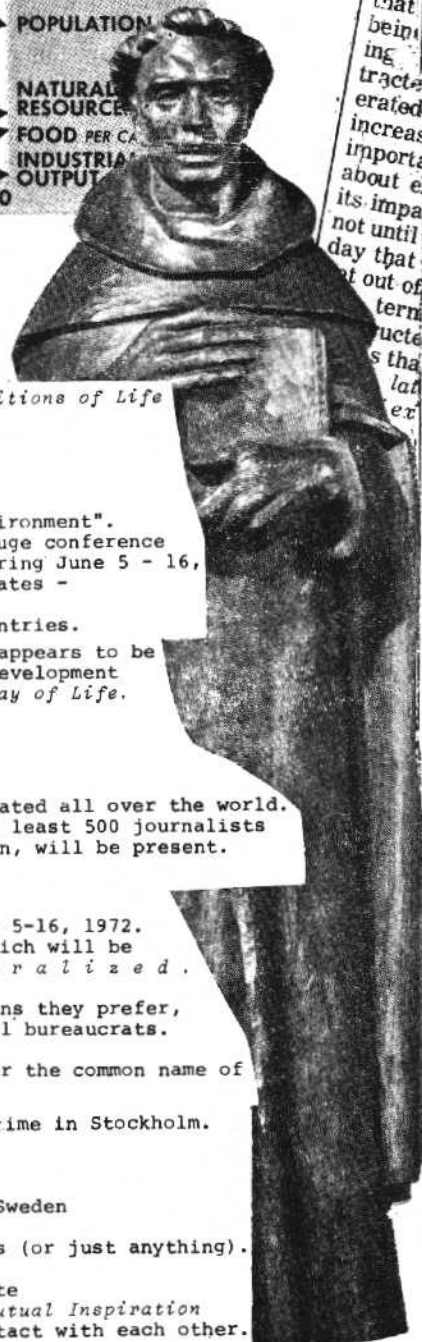

Forced by the intensified discussion of the *Conditions of Life on Our Limited Planet*, Politicians, Governments, Corporations, and International Organizations

have begun to talk about the "human environment". With this title the United Nation is planning a huge conference to be held in Stockholm, Sweden, during June 5 - 16. The conference will be visited by some 1200 delegates - primarily politicians - from more than a hundred countries.

They will formulate the *Issues* so that the task appears to be to *Modify the Consequences* of the current development rather than to *Create a New Way of Life*.

They will present *Endless Resolutions* to convince us and maybe even themselves that our future is in *Good Hands*.

The "Message" from the conference will be propagated all over the world. At least 500 journalists from newspapers, magazines, radio, and television, will be present.

OUR TASK IS CLEAR!

Get together and do some *Thing* during June 5-16, 1972.

Join these actions, which will be *decentralized*.

Every group undertakes the kinds of actions they prefer, and no one will act as international bureaucrats.

In Stockholm many events are planned under the common name of *POWWOW*.

We have been working with the POWWOW for some time in Stockholm. Our address is: POWWOW c/o R.Noonan
WGC / M-22
Sveavägen 166
S-113 46 Stockholm, Sweden

So write and tell us about your ideas and plans (or just anything). Then we can pass it around to all groups that want to participate *For Mutual Inspiration* and to enable all of us to get in contact with each other.

Awake!

"It is already the hour for you to awake."
—Romans 13:11

It is now reasonably certain (since the discovery of significant amounts of DDT in the penguins of Antarctica) that *all* the fish-eating birds as well as the land-going carnivorous birds and those which formerly ate insect pests are doomed. It is probable that all the carnivorous fish will soon contain too much DDT for human consumption and may themselves become extinct. It is possible that the earthworms, at least in forests and other sprayed areas, will vanish—with what effect upon the forests is anybody's guess. The plankton of the high seas (upon which the entire planetary ecology depends) is believed to be still unaffected.

... *all* of the many current threats to man's survival are traceable to three root causes:

- a) technological progress
- b) population increase
- c) certain errors in the thinking and attitudes of occidental culture. (Our "values" are wrong!)

We believe that all three of these fundamental factors are necessary conditions for the destruction of our world. In other words, we *optimistically* believe that the correction of any *one* of them would save us...

It appears, at present, that the only possible entry point for reversal of the process is the conventional attitudes toward the environment...

That the very first requirement for ecological stability is a balance between the rates of birth and death. For better or for worse, we have tampered with the deathrate, especially by controlling the major epidemic diseases and the death of infants. Always, in any living (i.e., ecological) system, ever increasing imbalance will generate its own limiting factors as side effects of the increasing imbalance. In the present instance, we begin to know some of Nature's ways of correcting the imbalance—smog, pollution, DDT poisoning, industrial wastes, famine, atomic fallout, and war. *But the imbalance has gone so far that we cannot trust Nature not to over-correct.*

That the ideas which dominate our civilization at the present time date in their most virulent form from the Industrial Revolution.

- a) It's us *against* the environment.
- b) It's us *against* other men.
- c) It's the individual (or the individual company, or the individual nation) that matters.
- d) We *can* have unilateral control over the environment and must strive for that control.
- e) We live within an infinitely expanding "frontier."
- f) Economic determinism is common sense.
- g) Technology will do it for us.

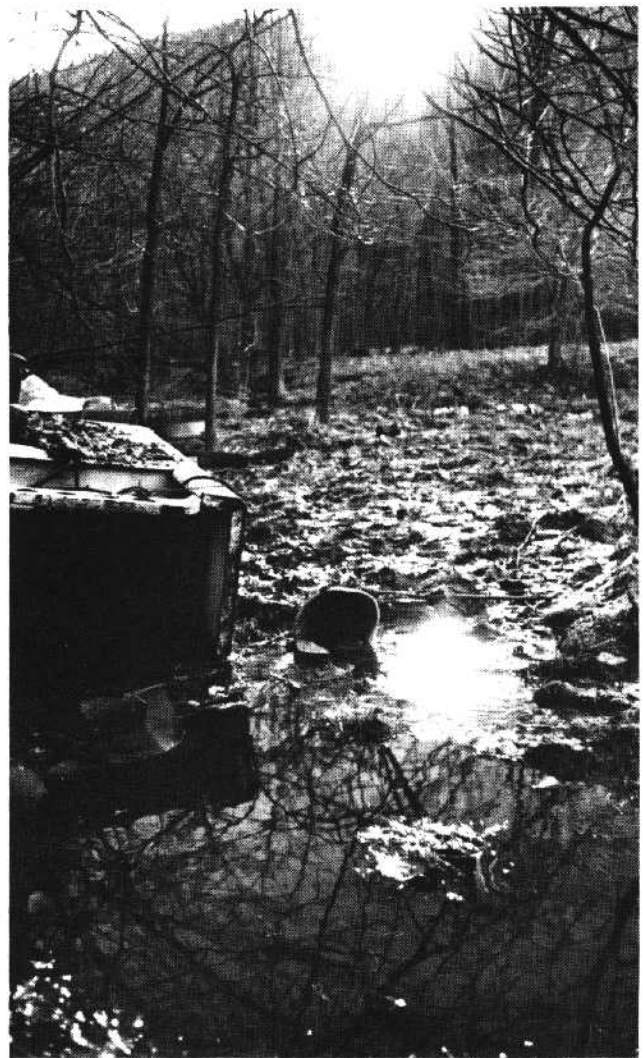

We submit that these ideas are simply proved *false* by the great but ultimately destructive achievement of our technology in the last 150 years. Likewise they appear to be false under modern ecological theory. *The creature that wins against its environment destroys itself...*

That change in our thinking has already begun—among scientists and philosophers, and among young people. But it is not only long-haired professors and long-haired youth who are changing their ways of thought. There are also many thousands of businessmen and even legislators who *wish* they could change but feel that it would be unsafe or not "common sense" to do so. The changes will continue as inevitably as technological progress.

That these changes in thought will impact upon our government, economic structure, educational philosophy, and military stance because the old premises are deeply built into all these sides of our society.

That nobody can predict what new patterns will emerge from these drastic changes. We hope that the period of change may be characterized by wisdom, rather than by either violence or the fear of violence...

By Gregory Bateson

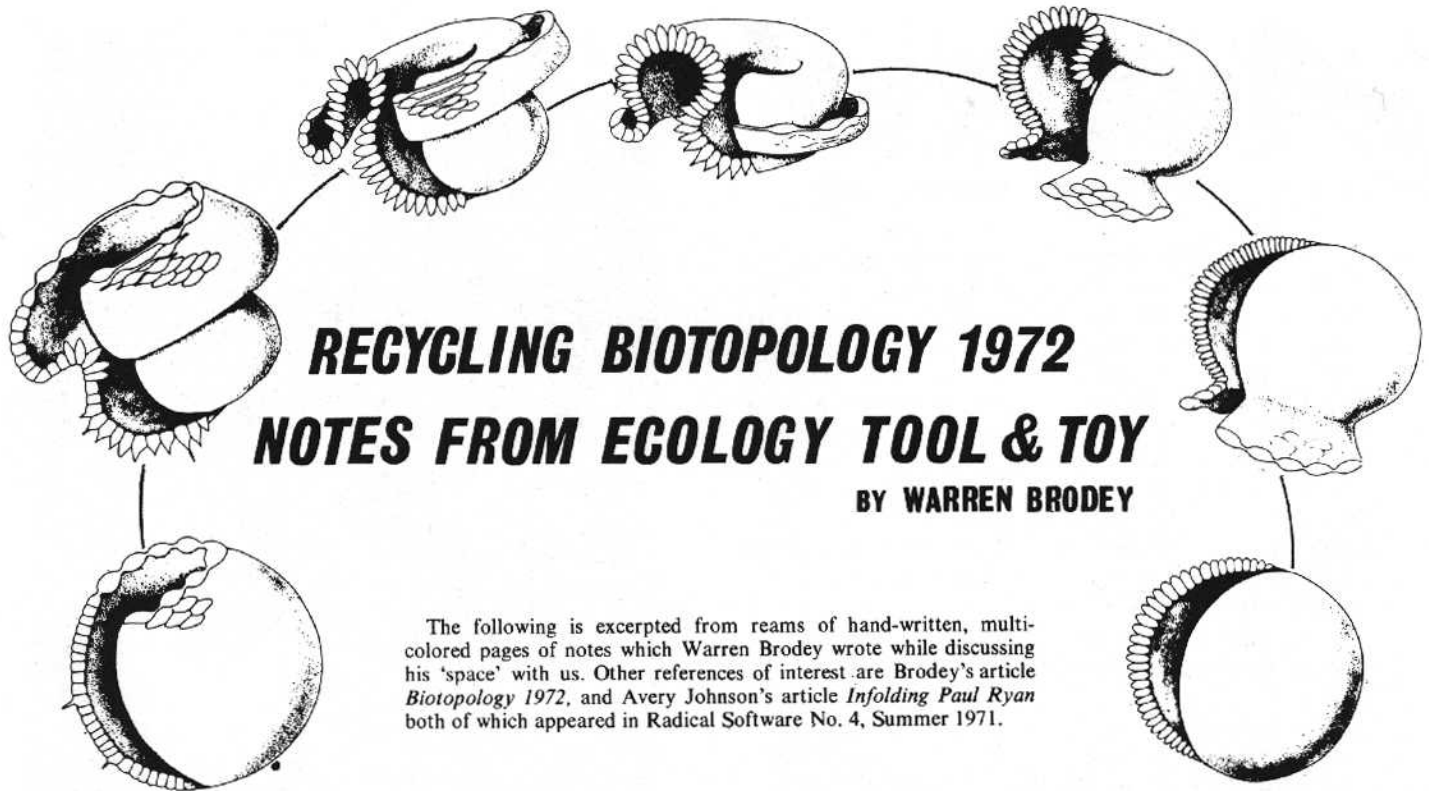

RECYCLING BIOTOPOLOGY 1972

NOTES FROM ECOLOGY TOOL & TOY

BY WARREN BRODEY

The following is excerpted from reams of hand-written, multi-colored pages of notes which Warren Brodey wrote while discussing his 'space' with us. Other references of interest are Brodey's article *Biotopology 1972*, and Avery Johnson's article *Infolding Paul Ryan* both of which appeared in *Radical Software* No. 4, Summer 1971.

I am working on building biotopes to play with, to learn consequences.

If I am lying down on a floor area which is an air structure made of interwoven kleinform that can expand or contract depending in part on their neighbors' behavior, the heat and light in the room, and on how I interface with its efforts to reduce its information to a manageable level, and the space itself is like being under the soft umbrella of an oak tree waving lively in the wind, or being inside a bubble of scum lively with creatures . . . what would it be like? Would we use verbal language as we know it, at all?

This is a different space. It is not a return to the nature of our ancestors . . . Or is it?

As Avery Johnson puts it, "The meaning to an organism of an object or an event is to be found in the response of the organism to it."

This different kind of space that I work in and play in and dig in even when I'm going nothing by mechimax values I call biotope technology; the technology of biological optimizing systems. If you live in that space or want to, let us know . . .

In this new space we go beyond being passive and we don't try to build dams and causeways to stop the waves as our way of being active . . . We build active surfboards that play with us and the waves.

If you read Norbert Wiener's book *God and Golem Inc.*, or McCulloch's book *Embodiments of Mind*, you will be closer to knowing that embodiments of biological-like behaviour make useful toys with which to engage in more dense communication with other surrounds and creatures. But both McCulloch and Wiener lived in the tradition of Science.

We know we must leave the old Space, Science, Technocracy, the world of Universals and Universe Cities . . .

As we find intermediate tools and toys that enable us to play with natural phenomenon, the level of gentleness and courtesy we experience is environment to other human and more varied species.

Courteous technology is not technocracy/bureaucracy.

A toy is not painful and you can learn without words. Animating a drawing is not like building a toy of material, energy, information that pays attention to trying to maintain its own kind of behavior—and is able to die. Soft systems are toys that have the richness of information texture that you see in a TV picture of a kitten but not in the printout of its parametric fragmented technocratic description.

You will understand better when you provide a TV camera, as Joe Seale has been doing it, with the capacity to look for density of information. Avery Johnson had an ordinary movie camera actively looked for edges following them. Imagine the TV camera is like a creature, the creature of the feedback patterns and you and this creature work together to find patterns that you might not have seen by yourself. Imagine walking among trees you have been dancing with, rhythmically making visual patterns with. How differently they will feel. My experience is that you begin to notice slow rhythms that become an envelope of complex rhythms, gentle yet urgent that bring you to a longer now, a sense of non-frenetic time within which one's—my life energy is augmented, and life itself is enhanced.

We are playing with ways of changing VTR systems so they allow the user to play time games, to use the VTR as a tool for studying ecology.

Build a TV set that is like your eye . . . it looks for what it wants to see.

continued

The new soft technology, soft control, soft systems are embarrassing to those who live in the print world . . . soft architecture is revealed by the plant as lecturer in experiencing biostructure . . . the plants way of coping by materially, informationally, energetically behaving in time.

Soft structures are like sponges with kleinform cells, that impinge on each other by pressing, exchanging heat chemicals, each cell is a space not a boundary. We are cells in the maero beast we call the System, we crowd, we exchange heat chemicals with our surround which loops these and many others back through our System to become a part of the uncontained portion again and this vitality is a fine structured flow of consequences intertwined.

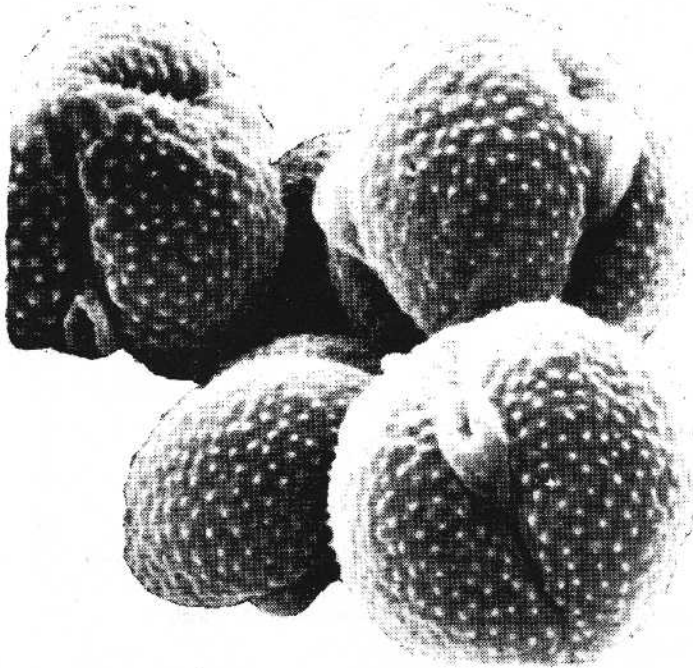

I found a new way to think of kleinform. Remember I said there was a world of spherical cells. This is what you see when you cross section dead biological material and deny its liveliness as expressed in energetic and information flow that does not stay inside the snapshot boundary. Behaviours loop around the cell walls permeating the spaces that coalesce more densely . . . but do I mean information spaces, energy spaces, timely rhythmic similarly spaces. No! Put these all into one unfragmented living way, there are no words; build it. But loops over time spiral and we're still talking linear holes and spaces are not spirals; the loop crawls out of itself extending beyond its boundary bit by bit. Oh, this sounds like nonsense. As Joe Seale put it, imagine your hand on your hip and thus forming a loop of energy, information, material and then your elbow sprouts a purple flower that grows breathing its way into the center of the loop, joining its walls to the donut (what a terrible word . . . for something so beautiful as a flower growing out of your elbow and breathing in the space your arm encloses.) A kleinform is not a cross section of a stopped click snapshot.

It flows back through itself, defining itself as it flows. A relation with Joe cannot be a snap shot. He has no energy for unshared space with unshared resources.

Each person is a clump of ecological meaning that can be known best in his way of giving meaning to what we experience as sharing.

Do Soft Structures have any value as meta tools? Yep, gets you unprogrammed, teaches you about ecology. Courteous systems cannot be mechanical, timeless, objects.

If the material is hard with hinges and joints, there can never be enough variability freedom to engage in nonlinear multiplicative activities.

Can you build a structure that in the simplest way behaves like the plant you are watching. If you try you will ask yourself questions that no descriptive biologist ever thought to ask, in your new problem you are asking synthesizing questions not analytically fragmenting.

Consider . . .

A chair-like structure, that if you move so it rocks forward inflates a pad under the small of your back so that it is well supported, or oscillates several rhythmically swelling air bags so they relax your back.

Or try telegrasp . . .

a system made of plastic foam, air which can expand/contract locally which tries to keep its movement organized in a manner relative to what's happening in its environment. Its movement may be mediated by telephone so its head is in Chicago, its tail in New York. If you massage its head, its head and tail will both react so as to try and maintain their connected organization in spite of your interference. The behavior in Chicago relates to which way you touch the lively system in New York and so the person grasping the head in N.Y. will receive information as to the style with which the tail was grasped in Chicago. Thus begins the technology of biological-like soft systems as a tool as well as a toy.

I speak of assembling a critical mass of toys made by people who are using them as a language to imitate and evolve their way of connecting softly with wind and shrubs and paramcium.

You won't understand as easily until you watch a time lapse image of a paramecium (a single celled critter) and try to build a much larger swimming thing that moves like a paramecium, whose image you can overlay on the image of the critter, now slowed or speeded as well as changed in size so you can imitate it even by overlaying an image of your own body as you try physically to dance in rhythm with its dance.

continued

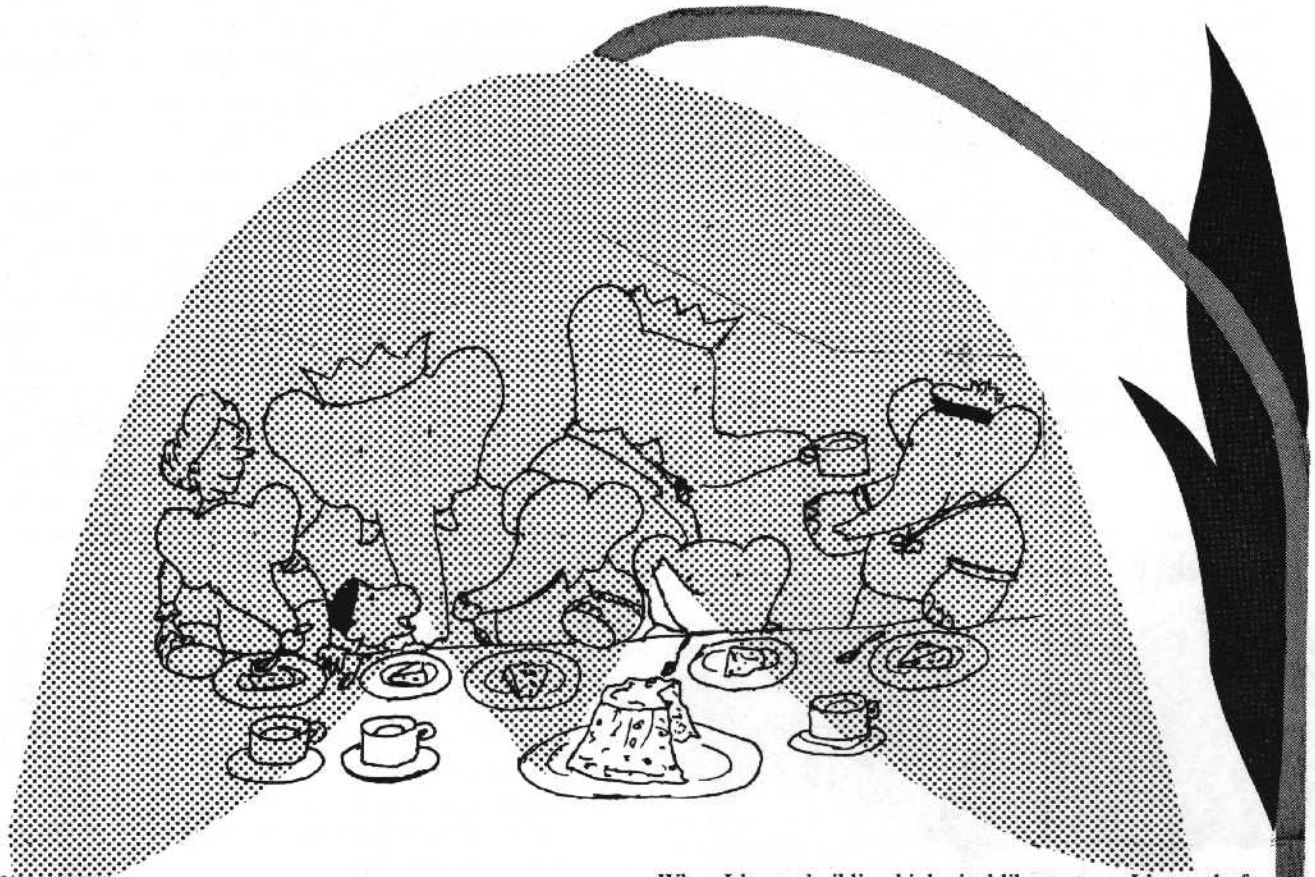

My Worm:

I built a worm-like lively thing one day two years ago. I made it about a foot long and about 3" in diameter out of polyurethane. I had valves, actually fluidic-flip-flops on-off valves, and I attached them so each of the 5 segments swelled then contracted one after the other. I watched caterpillars and worms, and snakes to try to figure out how to do it. They were teaching me, and the more I tried to get my worm to put its stiff velvet pile feet down and push on the cloth so it would move, the more carefully I watched how creatures do it cause I had a problem—A way to figure out an alternative to wheels. Anyway I did get the peristalsic wormy motion and I did get it to move along. Then I figured a better way for my purposes, I would like someone else to build one—sometimes I imagine a lot of people getting into it.

Over that place you eat build a dome of velvet, get a beach umbrella . . . gently let it change the way it drapes with the frequency pattern or loudness of your voice; or build the chair that pays attention to your shifting about—a simple electric wiggle meter, a pressure switch, each time you wiggle you compute structurally like leaves reaching for sun, that can create more optimal forms of energy out of diffuse, less structured forms.

Build it to touch. The house you live in programs you . . . it is a command language . . . you are forced to make body decisions that do not optimize your energy . . . you are faced by soul murder where concrete and steel deny your body access to the energy flow of other plant and animal and living spaces.

When I began building biological like systems I learned of my need for the new space. But I like building a nest and toys so I thought it best to use my building and making and thinking and playing to learn again from other creatures.

Well, this is a taste of the space which has been our alternative to doing nothing while we climb out of the mechimax death trap.

Ecology Tool and Toy Network will happen if people can make a meadow of high variety participation, a forest of protective umbrellas under which seedlings can grow to know their effect.

I will enjoy communication by tape or any other exchange. But here I must leave off. If you have followed me into this space you may lead me through the enormous holes I see all around me filling them with energy/information—materials—time which as it resonates, converges, or dies, or provides the surprises which may evolve the means of survival.

We must leave the old space. There is no life there.

We are in very different territory.

You can contact Warren Brodey at Ecology Tool and Toy, Armcry Road, Milford, N.H. 03055.

WANTED

The Annual Report

people who might
 qualify to work in a Troupe. Qualifications mean
 experienced video artists (2-3 years work and able to
 devote six months of work
 experimenting at the T.P.
 and,
 amongst ourselves hopefully
 at the end of that period.

we shall be able to communicate
 interact together with the audience

FOR THE T.P. TOWER PLAYPEN

Image Bank
 4454 West Second
 Vancouver 8, B.C.

To Mike &
 Image Bank
 artists

sitting on top of the Chelsea
 I
 we now have a miniature video theater

workshop I have designed an
 environment

Ant Farm calls 'enviro-image'

this by forming a troupe
 (six people to start)

some will leave

split as paramecia do

only to double
 grow and again

garden with access
 equipped with
 as a patch
 deck and
 Eric Siegel
 color
 space
 portable
 when
 dies
 ser.

be able to pay them but if they would like
 the experience of working with a lady direc
 under manic conditions and in an atmosphere
 of total hysteria (it might even be fun!)
 feel sad that I've only been on

the receiving end happy to
 find a way to respon

Anyone interested in becoming
 belonging to the Troupe

can reach me at the Chelsea Hotel or phone collect
 Take care. Love to all.

SIGNED
 LOVE



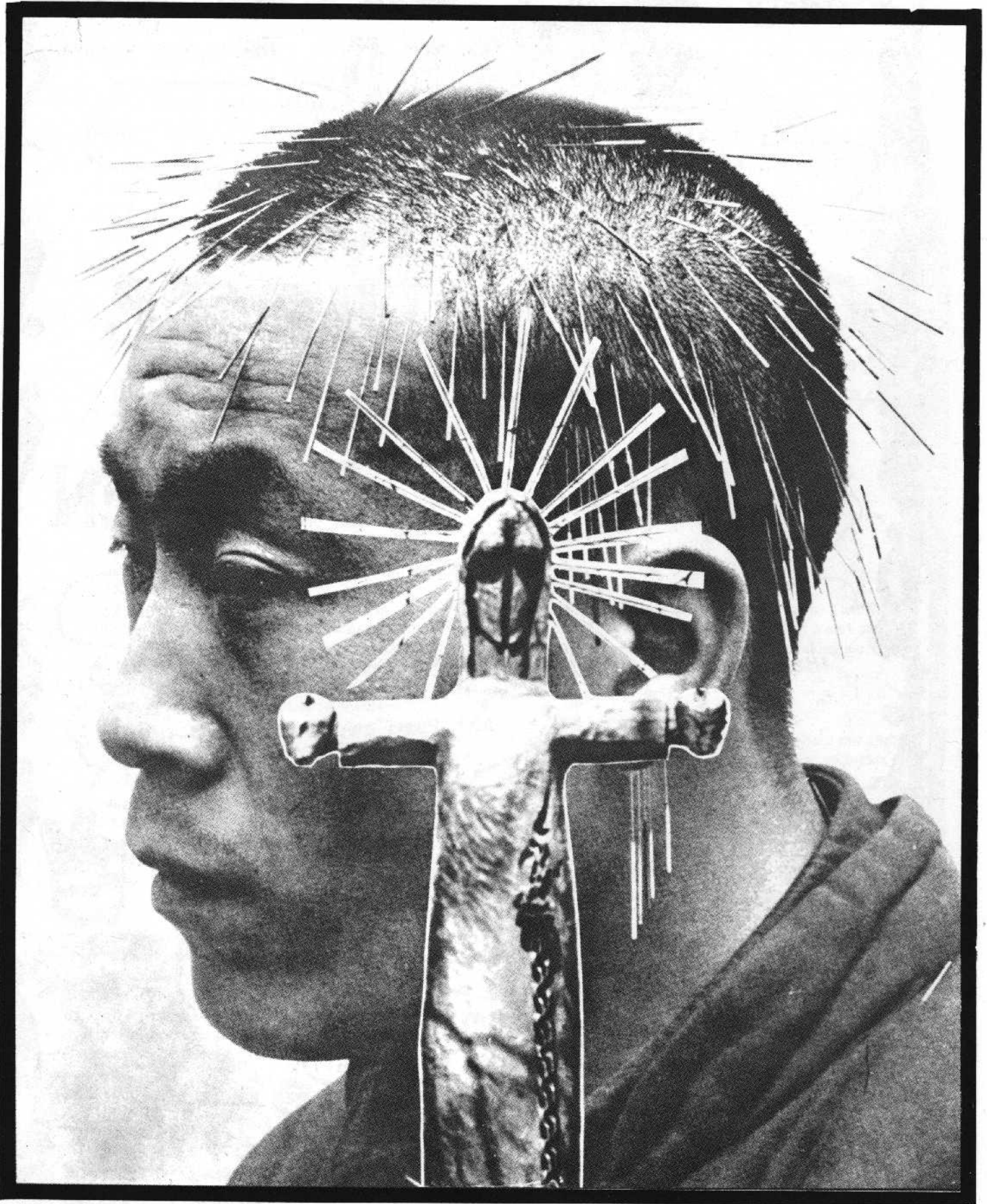

FROM CRUCIFIXION TO

CYBERNETIC ACUPUNCTURE

by paul ryan

In the current cacophony, the crucifix re-emerges for many as a meaningful symbol. The Christ of the Gospels understood how his crucifixion would function as an attractor. "I, if I be lifted up, will draw all things to me". The universal experience of suffering misunderstanding and abuse in spite of maintaining "good intentions", finds ready referencing in a man of love hanging on a cross of contradiction.

It is well to look at the structural stability of the crucifix itself. The totally non-foetal openness of the figure depends for its openness on being nailed hands and feet to the cross. By contrast, as discussed above, the Buddha lotus position maintains a self-referencing stability in the balanced positioning of the legs. This enables the hands to open to the other without stigmata.

We can note also that the cross itself is a homeomorph of the x/y coordinates of Euclidean space. Nails maintain a man at the center.

This pattern of man depending on a fixed relation to an "external" object for his psychic stability has recurring homeomorphs in the West. It is a pattern that seems to have much to do with Western man's ability to tolerate and desire technological development. The emotional "software" set of a man driving his car, a set configured by the advertising chreods* of capitalism, can be taken as a homeomorph of Christ on the Cross.

In our current state of disillusionment with "technological progress", we might say that Evil Knievel, leaping across a private canyon on a jet-propelled motorcycle because life is boring, is a technological *reductio ab absurdum* of Christ on the Cross.

Fuller's dictum, "reform the environment, don't reform man", moves in a similar hardware—software vein. Fuller's great utopian vision depends for its stability on the stability of his geometric structures. Re-engineer the environment, and man's ability to get along with his fellow man will be stabilized in utopian fashion. In his vision there is little appreciation of the need to restructure the primitive emotions.

This Christian code has its consequence in the realm of intimacy. Love becomes impossible without taking the cross into the realm of the intimate. In his book *Maria Cross*, Conor Cruise O'Brien skillfully describes this phenomenon in terms of the imaginative patterns of eight Catholic writers, including Mauriac, Bernanos, Greene, O'Faolain, Claudelle and Bloy. With appropriate qualifications about generalizing, O'Brien nevertheless articulates the central theme of their writing as follows. "Woman is the cross". Then more precisely, "Woman becomes mother and that is the cross". Charges of male chauvinism are readily acknowledged. All the writers are male. Patterns of crucifying the beloved in the realm of intimacy are mutual. We know not how not to cause pain.

*Chreods—Structures which describe and support a process.

Referencing pain is a most difficult process. Neurologically, no nerve net is exempt from pain. Physicians tell us that amputees cannot think of their pain without imagining the missing limb. The wounds of life are extremely difficult to understand in terms of source of affliction. Yet the signal system of pain is part of our experience. We tend to hold onto our pain as a way to ground our knowledge of our experience. We know because it hurts, and perhaps the remembrance of the hurt will enable us to avoid a recurring hurt.

The cross is a crude referencing system for pain. A wooden image of a double bind. As a compelling chreod, however, it tends to attract all phantom pain in search of referencing. People fall into patterns of trading on pain. Pain is reified and dealt by pain merchants.

This distortion has its converse in what the psychiatric profession refers to as sado-masochism. People refusing to resign themselves passively to an impoverished realm of crucified intimacy will strike out or invite being struck. The cross becomes transformed into a club. In McLuhan's exquisite phrase—"violence is a lust for compensatory feedback".

*"Christian Wars they tell the sin
No one managed to save him."*

Bob Lenox—*Train* album

The man was overdosed on love.
Nobody could handle it.

ACUPUNCTURE

Acupuncture is a Chinese medical therapy antedating Christianity by about two thousand years. The theory is that pathologies in the body result from disequilibrium with the universe. The equilibrium of the body is normally maintained by 365 channels that pass through the body and correspond to the harmony in the universe. These channels also correspond to 365 points related to the body's neural network known to the practitioners of acupuncture. Different pathologies are healed by the tender and attentive insertion of pins into the appropriate set of points on the body at the appropriate time. This results in a gestalt of neural excitement that cleanses the pathology and realigns the body with the harmony of the universe. Note that the human body is not considered as "central" but as "part of" the universe.

The self-processing through videotape discussed earlier allows one to think of self not as center on a private axis, but as part of a trial and error nexus of shifting information pathways. This is true in terms beyond the actual contexts in which taping of "self" is done.

continued

Being present to yourself on tape is not simply a matter of "seeing" yourself doing this or that—it is a neural phenomenon. This is a perception that McLuhan repeatedly tried to get across, especially to those who thought the difference between film and TV was only a matter of scale. TV is no more a visual medium because you see an image, than perfume is a visual because you can see it in the bottle. Electricity is an extension of the central nervous system. The TV image is an electric image, that "imbues the soulskin . . . sob consciously". It is like a pointillist painting—dots on a screen, similar to the points on the body known to the practitioners of acupuncture. As the hands relate to working clay, so the nervous system properly responds to the video mosaic through a "Lekton dance".* The basic motif of the dance is participation through imitation or converse response to the image. Variations become increasingly possible as one comes to know one's own and others' repertory of neural gestalts.

"Putting on" the body of another through imitation of video image opens up the possibility of cybernetic acupuncture as a mode of stabilizing intimacy, as opposed to mutual crucifixion. Rather than a professional interpreting the bodies' pathology in terms of an abstract cosmology and piercing the nervous system to achieve homeostasis, it becomes possible to share psychic stability through an electric intercoupling of nerve nets. Patterning complementary neural gestalts, is, of course, a delicate procedure and requires proper mapping of the "relevant informational pathways", of which the "selves" are part. Any form of "standing outside self", of ecstasy such as this, needs the objective correlative of proper mapping if the system is to maintain homeostasis. This does not mean an abdication of uniqueness. Bateson, in discussing the relations between members of Alcoholics Anonymous and the "power greater than themselves", has the following passage critical to an understanding of cybernetic acupuncture.

"This Power is felt to be personal and to be intimately linked with each person. It is "God as you understand him to be". Cybernetically speaking, "my" relation to any larger system around me and including other things and persons will be different from "your" relation to some similar system around you. The relation "Part of" must necessarily and logically always be complementary but the meaning of the phrase "part of" will be different for every person. This difference will be especially important in systems containing more than one person. The system or "power" must necessarily appear different from where each person sits. Moreover, it is expectable that such systems, when they encounter each other, will recognize each other as systems in this sense. The "beauty" of the woods through which I walk is my recognition both of the individual trees and of the total ecology of the woods as systems. A similar esthetic recognition is still more striking when I talk with another person."

From "The Cybernetics of 'Self': A Theory of Alcoholism," by Gregory Bateson as printed in *PSYCHIATRY*, Feb., 1971, 35:1-18.

*Lekton—"that in the mind like a fist in the hand." See Avery Johnson's article "Infolding Paul Ryan" *Radical Software* #4, Summer 1971.

Given the syntax of kleinform, any "part" consciously participates in the process of balancing the whole through moving in complementary modes of containing, being contained or being uncontained. The aggregate of "parts contained" provides the system with the needed redundancy set.

In Thom's terms, we can be "figures of regulation" for each other within greater "figures of regulation". The limits of this procedure, simultaneously self-referencing and participatory, seem to be in the mutual knowledge of one's own and others' unique Lekton language. Kleinform can provide stable closed mappings of the particular system within which corridors this electric intercoupling might take place. Proper mappings are necessary, otherwise pathology contains pathology in subjectively self-correcting inspin. Proper mapping can insure a synapse of Lektons that include the signal system of "pain" in an ecstasy that converts with appropriate electric figures of regulation.

This putting on of another's pathology or disequilibrium to heal is not new. It is the traditional role of the shamen in tribal society. As anthropologist Ted Carpenter points out, the electric rock music of today enables musicians to take on the role of shamen. Elvis Presley put on for purging the most characteristic pathology of the late fifties. The pitch of the head, the slurred speech, the roll of the eyes and the body movements were quite similar to those found in any patient in a mental hospital suffering from catatonic schizophrenia.

Currently Joe Cocker bodily puts on what McLuhan calls the "spastic search for feedback" of a world crucified by its own meaningless industrial hardware. Working with the driving power of the rock music, Cocker shatters the hardware hold into rhythms of released fullness. Similarly, in what might have been a complex double bind crisis, I have known the cross to dissolve into ecstatic gestalts of cybernetic acupuncture.

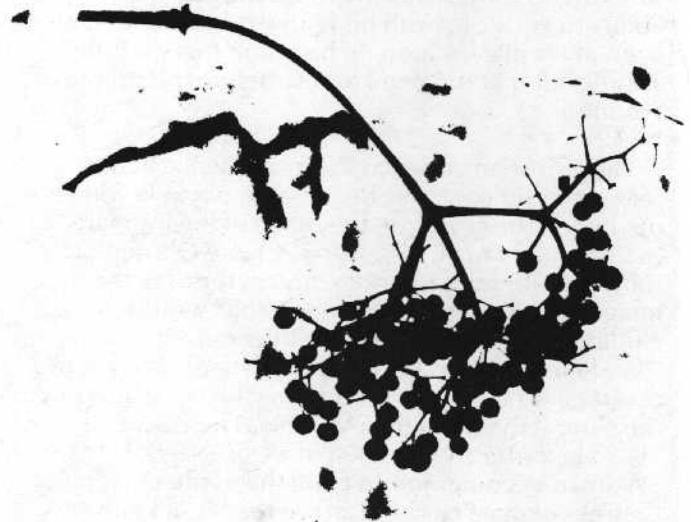

Excerpted from *Birth and Death and Cybernation: Cybernetics of the Sacred* by Paul Ryan. Gordon and Breach, New York. To be published in April, 1972.

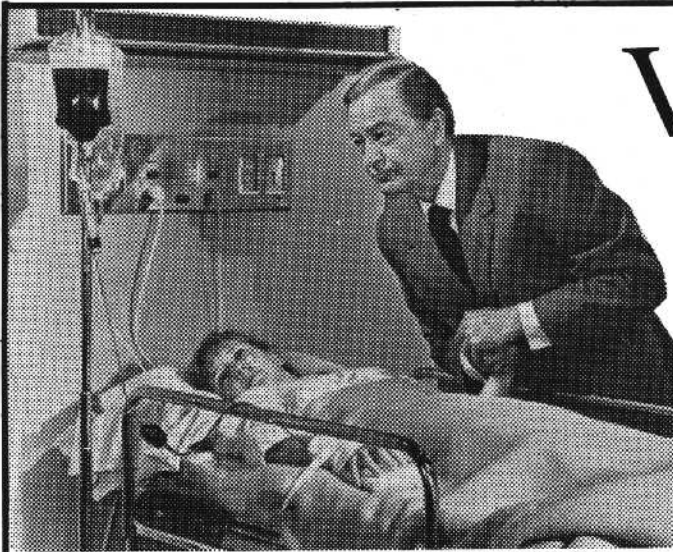

VIDEO AND HEALTH CARE

Structural change is coming late to medicine because the people who have catalyzed other institutional change are mostly young and therefore not in great need of on-line health services. While many young doctors disagree with the policies of the powerful American Medical Association, most do not want to jeopardize their hard-earned careers through active opposition. Those who are outspoken often confuse political rhetoric with practical solutions.

Two things are becoming clear: That the basis of health care must shift from curing to prevention. And that preventive medicine inherently places importance upon the complete environment in which a person lives.

The following two articles detail this trend. The People's Video Theater bring an understanding of new media tools to health care; and Michael Schwartz, a medical student, projects the needs of what he calls "second generation medicine" onto the capabilities of new media tools.

A study done by three students and a professor at Wayne State University School of Medicine (Detroit) gives strong insight into how we are misusing our most powerful information tool (broadcast TV) in the area of health care. For one week in late 1970 the group monitored 130 hours of broadcast television for health care information and found basically that information is fragmented to suit the profit needs of manufacturers rather than the real needs of viewers.

Their specific conclusions were:

1. Health-related items comprise a significant amount of a typical week of television, 7.2%.
2. 70% of these items are unsatisfactory as health education or information because they are inaccurate or misleading or both.
3. There is very little useful health information on television and there is almost no attempt to at health education.
4. Health professionals do not utilize television to any significant extent in solving important health problems.
5. Major health problems in the Detroit area such as heart disease, cancer, stroke, accidents, hepatitis, maternal death, hunger, venereal disease, mental health, sex education, child care, lead poisoning and family planning are virtually ignored by television.

From the study: HEALTH INFORMATION DURING A WEEK OF TELEVISION by Frank A. Smith, Geoffrey Trivax, and David A. Zuehlke. Medical Students; and Paul Lowinger, M.D. Associate Professor; Departments of Community Medicine and Psychiatry, Wayne State University School of Medicine, Detroit.

USING VIDEO IN HEALTH CARE by People's Video Theater

People's Video Theatre is an alternate media group which has been working with ½" video in metropolitan New York for the last two years. At present, we are a small working collective, supported in part with grants from New York State Council on the Arts and in part by commercial or contracted video work. As part of our objective to develop a community based television, our energy has increasingly been focused on a series of projects which we refer to as "health information". The purpose of this communication via Radical Software #5 is to describe some of the experiences which have oriented us to this project, explain what we understand by "health information" and why we think that this kind of approach to communications is valuable at this time.

Generating Information

Video Theatre takes place primarily in the public space. For us it developed as a result of working with liberation groups and around community issues. We saw that portable video with live feedback and various styles of selective feedback could define a space where people could psychically connect up with each other to create an information event. Initiated and recorded by a communications group with a sensitivity to how to move information, tape is shown to others who respond on tape and a process is begun whereby people have generated new kinds of information which they need and can use. We became aware of the need for health information through our desire to see this kind of event become the basis of a community-wide media experience which could begin to serve the real and immediate information needs of the community.

A sudden decline in health at 40 is often due to vitamin deficiency.

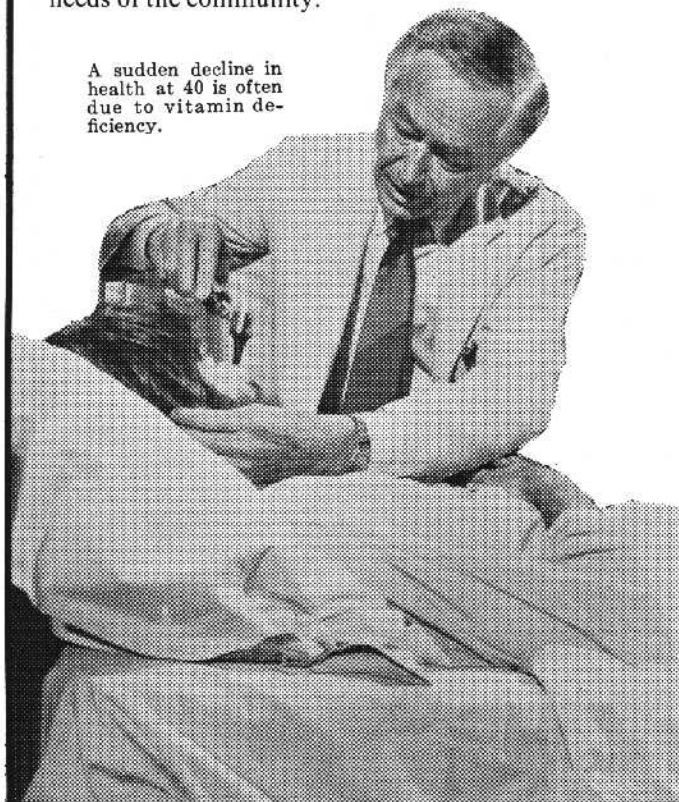

Initially our approach was to interview people in the street and parks asking them about the kind of health care they received and what kind of health information they could best make use of. We became aware that most people we talked to were in a state of frustration and confusion over their inability to connect up their own experience with the kind of information the health establishment was dealing through the various commercial media. Based on this, we felt we should start to create health information events utilizing as much feedback as was necessary to find ways of creating information about health concerns that people could trust and use. During the summer we made a series of tapes dealing with doctor-patient relationships in the examination and diagnostic process, peoples' and scientists' attitudes toward air pollution and their concerns about the effect of air pollution on health, and awareness of venereal disease.

The movement of these tapes was to try to bring together those sources of information and concern that are traditionally kept apart by institutional and class attitudes. The tape of V.D. was most successful. We went to a busy street with a doctor and nurse, set up our equipment with live feedback, and began asking people about venereal disease. People quickly got into using the doctor and nurse as an information resource for both their practical questions about V.D. as well as checking out some of their fears and fantasies of what it was all about. People with personal experience with various kinds of V.D. (especially one guy who claimed to have had clap forty times) began to fill out the linear, medical descriptions with graphic stories of what it felt like and how they handled it. In this way people began to exchange information, deal with each other's attitudes, with everyone digging each other on the live feedback—and the street temporarily became a place devoted to people's creating information for themselves. Using video in this way, we found we could analyse people's information needs, and demonstrate possible ways of meeting that need—though not on any expanded scale precisely because there is no real information media system to fulfill this role.

Health and Information Systems

Some groups don't have the problem of lack of awareness of a problem due to insufficient or bad information. Toward the end of last summer, we started working with a community of handicapped people (a summer camp) where the major concern was the isolation forced on the handicapped by a culture and professional elite which is both ignorant and hung up. Through getting into the equipment and designing messages to parents and non-handicapped people, people in the camp quickly saw video not only as a way of bridging their separation from the larger community, but also as a tool for documenting and presenting their needs to those who plan their space and administer their programs. Their goal is to resist the rip off that is laid on them by a professional elite and regain control of decision-making issues such

as transportation resources and space design-issues which directly determine their ability to relate to each other and the non-handicapped world.

As we got into the life of the camp, we found that with portable video we temporarily became the media system for the community. When a crab epidemic broke out and everyone had to be quarantined, we moved about with portapaks, connecting up different parts of the camp with information about other parts, and later playing back the whole drama and in the process, mediating between those who made a decision, those who had to implement it, and those affected by it. As a communications group, we found we could service a small community already defined by its special health need.

These experiences are related in detail because they have oriented us to a role through which we can have an immediate impact on a real information need. Video is like anything else, you have to learn to use it. Our experience has been that when people learn that with it they can become the productive means to generate information for their own situation, then they have the ability to take control of the issues of everyday life.

During the fall and winter, we've made contact with a large number of people, groups, and institutions which have either special health concerns or are involved in health services. Both through making tape and talking to people about media, we began to learn about the health system in this city. Like most other bureaucracies, this system is in an incipient state of collapse, with a growing inability to meet the health needs of all the people, and no prospect for reversing this trend. Grossly under-financed, with most decisionmaking coming from private interests, and virtually no feedback from those who carry out policy and are affected by it—it is an amplification of the overall American system that controls all our lives. It persists mainly through the fantasies which it generates through its own information system, which keep its reality at a comfortable distance.

On many fronts, people are beginning to deal with that aspect of the health system which hits them hardest. As groups make their own analyses, plan strategy, and take action, they begin to generate information which is useful to others in similar situations. Since this is not an information which is marketable, there is no prospect that it will be carried through commercially based media. It is also obviously not compatible with the political consciousness represented in profitmaking media. At this point, it requires groups and people committed to communications to create an information system which can deal real-information. In New York at this time, there are only two possibilities, closed circuit showings and the Public Access channels of cable Television.

The predominant attitude in New York toward the Public Access channels of cable television is one of defensiveness and defeatism. Admittedly, it's hard to see what it is that people could take for their own real use from this stupidly constructed cable system which, in its own way, is no less a rip-off than its rival—the networks. Cable operators will only strive to develop Public Access so as to sustain and protect their other real interests laid

down in the city franchise. It's obvious that one person can only watch one thing on one channel at one given time. If people are making programs and digging each other over the 2 to 5 Public Access channels, then the same people aren't watching commercial cable and broadcast programs, the potential advertising market decreases, commercial time is less valuable, profits lag, and ultimately the backbone of the information monopoly is weakened. But, to start from the beginning; how do you develop this constituency for public access in the first place? Our involvement with health issues has made us feel that there are small constituencies composed of special interest groups, defined by their health information needs, who could benefit from making programs and using public access to communicate first with each other and secondly with the larger community. For this reason we are interested in encouraging people to find cable outlets in the community so that if people with these outlets will allow their neighbors to gather to watch public access programming which they have made or are interested in by virtue of their own situation, than this will represent a step beyond closed circuit showings though not excluding them towards the formation of a constituency for public access and the basis of an information system specifically oriented toward real information needs. The ultimate extension of this process of constituency programming would be the formation of special channels devoted to programming health information.

These observations represent our attempt to make the best use possible of our experience in terms of the realities of the present situation. They originate in our desire to see video become an activist resource for social change. Health and a real-information system are two sides of any real future. We need to know how to take care of ourselves and develop support systems for keeping ourselves alive at a high level. If we can't do this, it's absurd to expect that we'll be able to know much about anything else let alone knowing how to take control of it when it goes out of control.

A catalogue of tapes dealing with health information and health issues as well as a wide variety of other topics is available by writing: People's Video Theatre, 544 6th Ave., N.Y., N.Y. 10011 (212) 691-3254

In addition we have material describing services available to groups, institutions, and communities wishing to learn about the use of video (and other media) for systems planning, mediation, and the development and facilitation of planning and action programs.

SECOND GENERATION MEDICINE

By Michael Schwartz

Second generation medicine is based on prevention instead of curing. Whereas first generation medicine began with the writings of Hippocrates and was allowed to develop over generations, second generation medicine has come quickly as a response to system overload and thus must be complete with first generation prejudices which insist on more hardware to patch up a crumbling system (more doctors, hospitals, better drugs, heart lung machines, etc.).

First generation medicine is heavily print-oriented. Printed matter is arranged hierarchically and facilitates centralized control. The feedback system is very slow, and although the quantity of information known may be enormous, retrieval of this information (access) is a very tedious process which requires pyramiding of knowledge into high specialization. As a result of print technology, we have a very highly centralized and specialized structure (hospitals and medical centers staffed with very highly skilled specialists). The result of the slow print feedback process has biased medicine in that knowledge can only be applied after something has gone wrong. Careful study of intervention-after-crisis is then written up in journals and later compiled into textbooks.

The acceleration and expansion of medical information has resulted not only in throw-away journals, but throw-away textbooks (try to sell a used medical textbook sometime!) Doctors now cluster in centralized structures so that they can "keep up" with their own specialties and have their flanks protected by other specialists. Urban ghettos and rural areas suffer most because of the former's overwhelming needs and the latter's decentralized locations. These groups have tried to obtain traditional medicine by the use of financial incentives and by outright takeover of medical facilities such as occurred at the Lincoln Hospital in the South Bronx, New York. This overlooked the fact that what is needed is access to health information pertaining to the South Bronx and not merely control of an institution which treats disease. Through the use of newer communications technology, systems which meet the demands for comprehensive, equitably controlled health care can be established.

Therefore, prior to 1970, there were two basic strategies to meet the health needs of America. One was to beef up the present system and the other was the medical radicals' attempt to take over the system.

In 1970, however, E. Grey Diamond drafted: "The open medical school, a community of scholars—the academic plan for the school of medicine, University of Missouri at Kansas City." In it, he correctly viewed the present crisis as one not of hardware or political control. The result is a plan for a new medical system which will stress decentralizing communications tools (newer technologies, such as computers and video).

What is the Kansas City Plan?

In 1969, the Missouri State Legislature appropriated initial planning funds for a new medical school in Kansas City, Missouri, in association with the University of Missouri at Kansas City. The location is on a 135 acre hospital hill which will con-

tain the buildings of the University of Missouri at Kansas City Dental School, Children's Mercy Hospital, the existing Kansas City General Hospital, a major acute psychiatric center, a mental retardation center, and a model extended care facility. The first-year class, which began in September, 1971, includes 40 first-year students, 18 second-year students, and 30 students in the third and advanced years. The curriculum is designed to achieve a number of goals: a) to individualize the education process for medical students by providing continual contact between scholars at all levels and by facilitating the access of these scholars to all necessary sources of information; b) to educate the students in a prototype setting of future offices and practice relationships; c) to develop a model university-community cooperation, where each component provides both programs of special concern and interest to it; and d) to provide the student with a relevant clinical and basic science model with which he can identify and to which he can aspire.

The educational plan consists of a six-year program coordinating two pre-medical and four medical years. The first two years consist of about 75% of the course work in the arts and sciences and the remainder in medical studies. During the final four years, the student will devote about 75% of his time to medicine and patient care, with the remainder set aside for liberal arts courses. Beginning with the third year, the students are divided into docent units. Each docent, a practicing physician who serves as teacher and counselor throughout the student's remaining four years, will be responsible for 12 students—three from each of the last four classes. At the end of the student's sixth year, he will receive an M.D. degree. The basic sciences will be available from all university disciplines with few, if any, departments created. The clinical specialty disciplines as such, will be available in the ten affiliated hospitals but their departmental organization will be responsible to that hospital, rather than to the curriculum per se. The student's space for operations will be in the medical school setting containing his office, those of his fellow students and a docent team. He will constantly operate out of this area, but it will remain his base of operations. Student clinical experience will be accomplished by a twelve-week rotation each year on a 20-bed general medical service, plus a continuing year round,

Aspirin can cause stomach upset!



four-year responsibility for out-patient follow-up visits. During these four years of the program, the student will maintain out-patient responsibility for the patients first met during his twelve weeks general medical service. He will schedule these patients, and maintain office hours as needed, to give professional services to his "practice". The evaluation of factual information acquired as students will be done on a challenged exam system. The student will be allowed to progress to more advanced responsibility on an individual basis in accord with his ability to perform both factually and clinically.

Information Resources

"Every known and approved method of communication will be utilized to make available to the student-practitioner (at whatever level of education) all needed information, on an individualized and immediately available basis. Included are such techniques as the "briefcase computerized library", electronic video recordings, closed circuit television consultations, "dial-a-consult", computerized fact banks, simulation models, educational games, didactors, medical records adapted for case history study base, and similar new information devices. The system will be designed to take advantage of the newest communications devices and place a premium upon their incorporation into the program." To accomplish the goal of a better health care delivery system, E. Grey Diamond states in his conclusion, "that the University of Missouri will not hesitate to modify, alter, or change this program in part or completely, reverting to the classic structure, if that is the proper choice."

As the first major proponent of second generation medicine, indeed, major modifications will occur. A contradiction exists in wedding the centralized structure of print-oriented disease-centered classical medicine to the newer communications technologies which are inherently decentralized and prevention-oriented. They certainly can and must act synergistically, but they must be recognized as two separate processes, each with its own vehicle of action. Thus, the internal combustion engine

Burrerln protects against stomach upset!

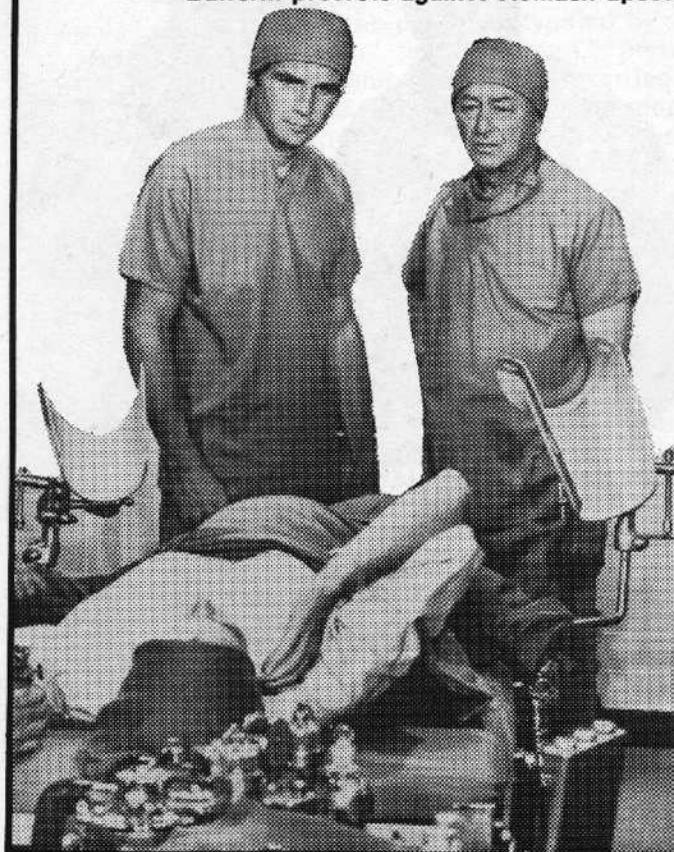

was not strapped on the back of a horse, nor is the electric light bulb designed to look like a candle, although both of the former are used in transportation and both of the latter are used in providing light.

Planning a building to contain 35 separate computer terminals and 35 separate video systems to deal with a community's health problem is equivalent of putting all of the community's telephones in one building. In other words, you can't simply put "every known and approved method of communications" in the context of the older print technology. The health students office, completed with computer link and video system, should be placed at 35 locations in the Kansas City areas with the highest incidence of health problems (health wards). Actually, since second generation medicine does not operate by palliation but by prevention, the system can begin with one or very few community locations and then expand with new but basically similar health stations manned by graduates of the first, together with health students from the newer community. The student would begin by functioning as a sort of computerized bare foot doctor (first line medical worker in rural China) doing door-to-door health screening, prenatal and well child care, dispensing information on nutrition, physical fitness and drug abuse. The student may or may not want to "advance" to the treatment of illnesses in the community. Persons from a health ward that had to enter the hospital could be followed (treated) by his community student doctor in person or via video monitor. This, of course, would be supervised by community docents and hospital-based specialists. When a person must be hospitalized, his previous history and previous physical findings are available from stored computerized data. This data contains longitudinal information of his history and latitudinal information about his community. Complex medical problems seen in a community health clinic can be immediately attended to by a video medical consultant, on call for his specialty to that clinic. Neither patient nor physician will have to be delayed by travel time.

Freshmen medical students at Northwestern University are working on their own time with the Pedro Albizu Campos Free Clinic in a Puerto Rican area of Chicago, in an out-reach health program. They leaflet a block of apartments announcing that they will be on the block on a given Saturday morning, then seven teams of community workers and medical students go door-to-door and do screenings for anemia, lead poisoning, sickle cell disease, urine testing as well as obtaining a basic medical history, including physical measurements. There is an unlimited amount of services that a home health care system can establish. The students feel that this approach gives them an understanding of community health problems and renders a service to the community.

Contrast this to the attitudes of a very short time ago. Four years ago, a friend of mine was a sophomore medical student at the University of Illinois in Chicago. She lived in a dormitory with many nursing students. The women she lived with would approach her with problems of birth control, hygiene, etc. My friend felt (rightfully!) that responding to the health needs of her community (dormitory) would distract her medical education—atomy, biochemistry, pathology. It is now patently evident that one must approach the patient, not only as an anatomical, biochemical individual, but as a member of his geographic and demographic community. Training medical students on hospital wards, a context isolated from the patients' total living environment, makes it difficult later for students to function effectively in that patient's neighborhood (not until they are sufficiently debriefed). The student is just not oriented to think of himself as functioning in the community.

The goals of second generation medicine are different, but complementary to those of first generation medicine. First generation medicine, being essentially centralized and special-

ized, has placed high priority on heart, stroke and cancer—problems that are best dealt with in a regionalized manner—therefore, we have regionalized heart, strokes and cancer centers. Second generation medicine, being essentially community and prevention oriented, will have goals of conquering communicable diseases (TB, VD), decreasing infant and maternal mortality and morbidity, aiding in family planning, genetic counselling, drug problems and nutritional problems.

Similarly, first generation medicine has made hospital delivery of babies almost universally accepted to the extent that in the United States, only one home delivery service now exists—The Chicago Maternity City. Originally founded to serve wealthy “Gold Coast” women in Chicago, the Maternity Center services now go to only poor ghetto families and a few “radical” women. By basing the practicing health student in a neighborhood, and by giving good prenatal care, the home delivery of babies can again become community experience. This may lessen the risk of hospital-borne infections by highly resistant strains of bacteria. The incidence of maternal blood clot formation may also be reduced. Instead of starting off life in a newborn nursery, a child would begin in his home with family and friends.

A new medical format will define its own practitioner. Since the new style doctor will function mainly in the community, he will probably be selected or at least represent that community. The traditional paternal doctor role will be changed and probably will result in a preponderance of women practitioners. The work week will be shortened as a function of less demands upon the individual health worker.

This article has been an attempt to analyze the coming second generation of medicine (health care) with an attempt at feed forward. The important message is not that medicine will take the shape as envisioned here, but that we must see it as a process resulting from the technology available. The following illustrates how new tools may be used to reshape health care.

The impact of the discovery and development of anesthetics in providing the basic technology necessary for the expansion of surgery has recently had a parallel in the field of preventive medicine and it almost went unnoticed. In August, 1969, at the Woodstock rock festival, several unknown persons with portable one-half inch video cameras, went to the makeshift general hospital and taped the ongoing care of acute illness—drug reactions, cut feet, dysentery, etc. and interviewed both doctors and patients. They then went (according to one source) to various locations in the community of 200,000 persons and played back the tapes, thus providing rapid health information feedback to persons who could then act to modify further problems of this type. Enlarging on this system, one could anticipate setting up a continuous, instantaneous feedback process. This could be mediated by a professional health ombudsman, much as a professional football game on TV is moderated. The delayed process of putting medical information into print to be interpreted by health professionals for the benefit of the community is thus circumscribed. Many more medical uses of the new technologies will be discovered as these tools are made available.

MICHAEL SCHWARTZ

Michael Schwartz is a medical student at the University of Arizona. He will begin his internship this Spring.

Bufferin acts twice as fast as aspirin for millions, even faster for many others.

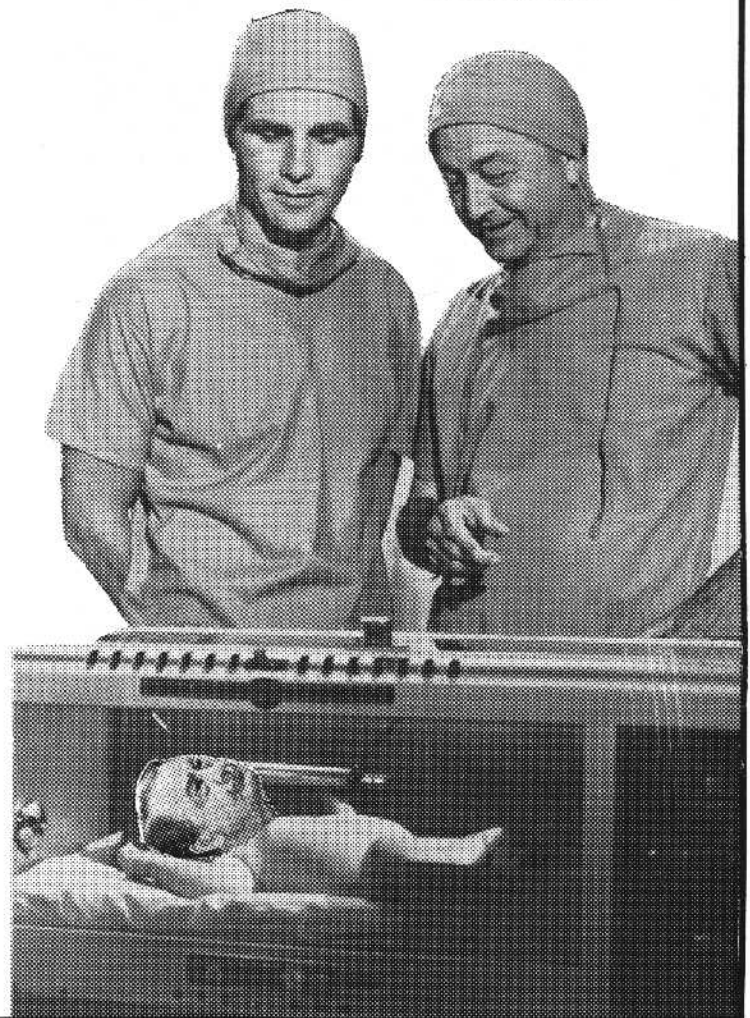

G E S T A L T

L E A R N I N G

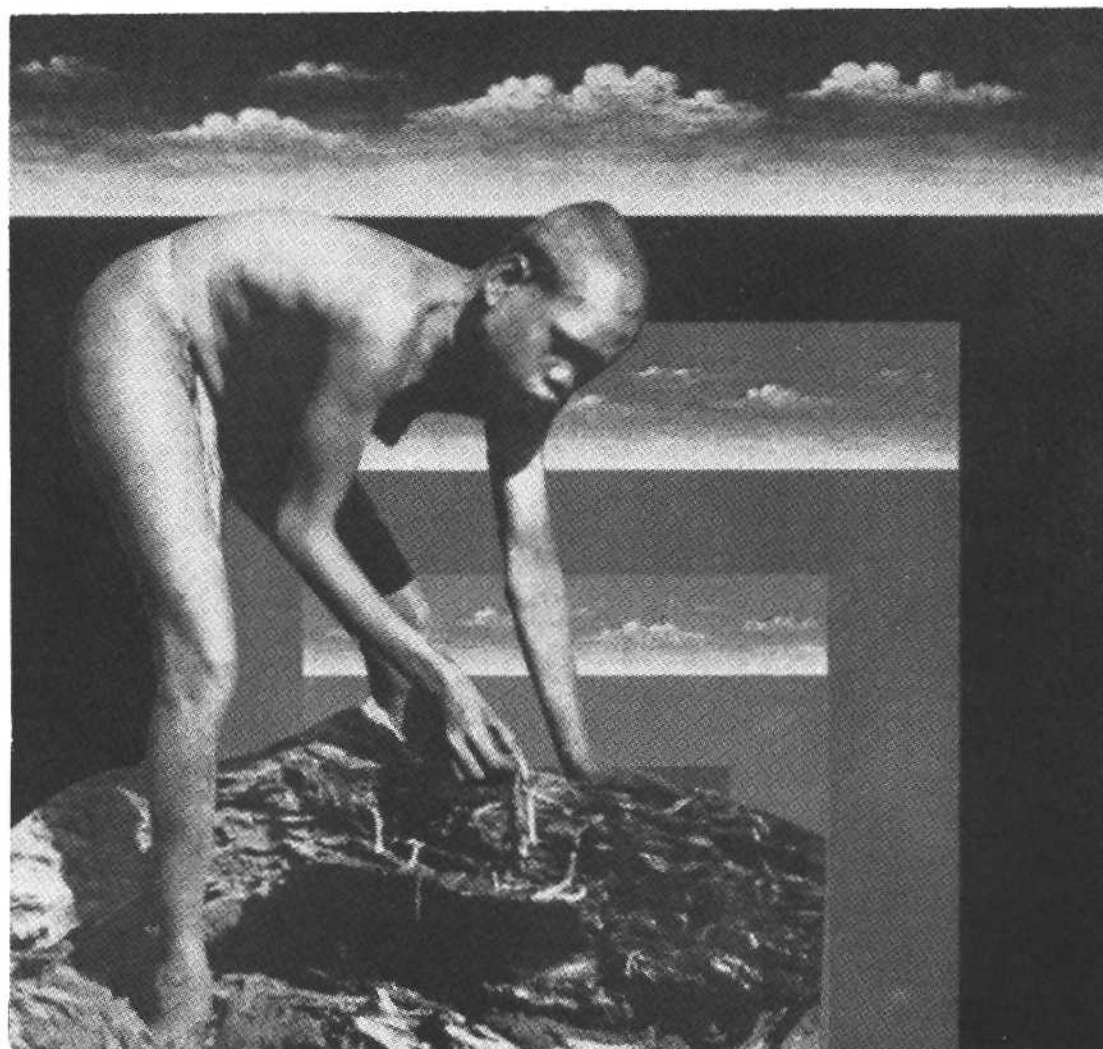

collage: Jodie Sibert

The Research Programme's initial interest and concern lies within the processes typified by such words as 'perception,' 'intuition,' 'art,' 'personal growth,' and 'community.' All research carried out is guided by the *structural principle of interdependence* (of disciplines, concepts, etc.), concurrent with a systems approach and orientation; the exploration of 'inner space;' and the assimilation of realizations resulting from the merging of thinking (logical reason) and feeling (intuitive thought) with the belief that life and art are *not* separated and that both the beginning and the end of action lie in individual experience.

Initial physical facilities planned include a *Music Building* which will house an Experimental musical Instrument Collection and laboratory, a collection of ethnological instruments . . . a *Machine, Materials and Electronics Building* containing a full complement of industrial-rated machines and tools for both metal and wood working, work areas, and a small electronics design shop; a *Hermitage* consisting of small, individual, isolated buildings set deep in the forest area where seminarians can be alone and quiet; and an *Audio-Visual Centre* containing video and sound recording facilities, a graphic and photography area, and a central meeting and performance area where resource people from the arts, sciences, and other disciplines will interact . . .

One project involves the establishment of a 'mode room', a place where all of the musical scales and systems known to have been used by man are stored for study and comparison on both musical instruments and a mini-computer system . . . As a result of our 'Brain-Wave Music' seminar held earlier this year, we will begin our explorations of bio-feedback systems this fall.

Naturally, many of our projects and experiments presently carried out involve our on going research in Gestalt 'techniques', the awareness continuum and human potential in relation to an individual's total psychophysical stance. Emphasis lately involves the use of Individual Intensive Gestalt Work for the exploration of an individual's defense systems as related to his unfinished childhood situations. Other areas which are fundamentally part of the Institute's commitment to a re-searching of awareness in all its aspects includes work with the various yogas (hatha, pranayama, etc.), horticulture, nutrition, acting, music, movement, learning difficulties, perceptual and auditory handicaps, etc . . . All the aforementioned projects have been or will be documented in the form of papers published and distributed by the Centre, video tapes or tape recordings.

John Grayson
Research Programme, Kuper Island Centre
Gestalt Institute of Canada, Box 779
Chemainus, British Columbia, Canada

Towards a Video College

Antioch/Baltimore is developing into a change-oriented, alternative institution totally permeated by the use of and experimentation with video. We have become an active experimental support system for all courses and concerns of the new Antioch/Baltimore BA program.

Since the BA program is project centered and community based, the video faculty is able to serve as consultants to students and community groups. When students and faculty in various departments develop courses, projects, or contracts, a video component is frequently included. This type of continuous, inter-disciplinary input provides a reality production context and, oftentimes, for advanced students, paying jobs in video projects while working towards a BA degree . . . Students have the freedom to design and explore new communications models and practices with the support of not only a video faculty, but faculty in social research and in the arts . . .

Video Theater (with theater arts, music, photography)

A weekly theater experiment employing theater games, video projections, multiple monitors, SEG, actors as catalysts, VTR time and space control etc., to provide a video-mediated communications environment.

Self and Group Processing (with psychology and social work skills)

Continuing experiments to refine the use of video in group dynamics. Much in-house use of VTR to record and critique interview techniques, psychodrama situations, and group interactions. Current projects include a marijuana seminar using VTR to compare "straight" and "stoned" sessions. A VTR history is being kept of the process of the Antioch College education experiment in Baltimore.

Alternative Media (with journalism)

Production: Preparation and distribution of a Baltimore "newsreel" made up of edited clups from all the longer tapes produced at the Antioch center. Special segments are also prepared strictly for newsreel play-back. Mobile guerilla play-back sessions are held in the community. Completed "product" tapes are prepared for alternative distribution (Mayday Collective, Urban Survival, etc.)

Community Communications (with Social Strategies)

Work with individuals and groups in the community (Model Cities, YMCA, Youth Councils, Street Clubs, Jaycees, etc.) to design appropriate communications models for action programs. The tapes are useful in the community and feedback into Antioch as raw material for courses and seminars. This two-way flow of expertise and information has worked well. Many of the community resource persons who have worked with us on taping projects have joined the program and continue in the dual role of BA candidate and community communications specialist.

Research: Cable Television task force is studying the policy and production issues with an emphasis on community access. An Institute of Press and Public Policy is forming which will oversee watchdog projects designed to make local media more responsive and responsible to its consumers.

Distribution: We are exploring an active local (Baltimore-Washington) distribution mechanism with linkages to other alternative distribution systems.



A WORLD SYSTEM OF UNIVERSITIES AND COLLEGES

Colleges and Universities as we have known them gobble up young people and process them into specialized servants of civilization. Young people are trained (to confine their thinking to established disciplines and restrict their behavior to established patterns) by older people who are themselves quite confined and restricted. But, since the glories/tyrannies of civilization are incompatible with our continued survival on Spaceship Earth, it is necessary to transform these institutions.

The word "university" implies an institution concerned with the universe, an institution concerned with individuals as whole human beings in relation to their whole environments. So let's imagine a university system which includes all people as members and which is designed to enable us to continually learn a better living in the universe. This would be a general organization, conterminous with "society," which would enable us to cooperatively integrate our lives, formulate basic policy decisions, and share the joys and struggles of sentient existence. Through this university, we would have access to the accumulated wisdom and technology of humanity.

Let's begin by recognizing that each person is a self-organizing system and constitutes a university in her (sic) own right. Individual universities can form family universities, family universities can form neighborhood universities, and so on. Within family universities, we can learn to be loving and healthful in the primary activities of living. Within neighborhood universities, we can provide for kindergartens, seminar and information facilities, suitable homes and gardens, a transportation pool, etc. At the community scale, we could support a cooperative store, a basic health care team, a small research and development group focusing on housing, food production, waste management and communications, an exchange program with other communities around the world, and such other facilities as may be appropriate for seventeen hundred self-actualizing persons. At each degree of scale, there might be a university council with responsibility for orchestration of living/learning so as to achieve optimum synergy. The university councils would work to insure that we do not lose sight of whole human beings and communities as we move to develop and apply our knowledge and technologies. Concurrently, the colleges would work to insure that our concern for the well-being of all human beings everywhere will not bog down in mere good intentions but will be supported by a surge of creative activity, each person being enabled to make his or her special contributions.

GRASP, Group Research and Articulation Systems Project
Don Benson, Mud Creek Road, RR 1
Murphysboro, Illinois 62966



This program is to give people from 14-18 an alternative to learning in the conventional schools. We want to help provide contact between apprentice and master, student and mentor, learners and teachers all over the country. "Apprenticeships" have traditionally been the way of teaching crafts and trades. We think that trading some work for learning from and with someone is a good way of learning ANYTHING. A distinction that has to be made is that in some fields the apprentice may actually be qualified to do the work after the apprenticeship is over, for instance, be a weaver. But in some fields, though he may learn a lot, he will still have to go through qualifying or licensing procedures to actually be able to practice. The point of the apprenticeship in these fields, like medicine or law, is that the apprentice will have a better idea of what it is like, and have some realistic basis on which to decide whether he wants to go on.

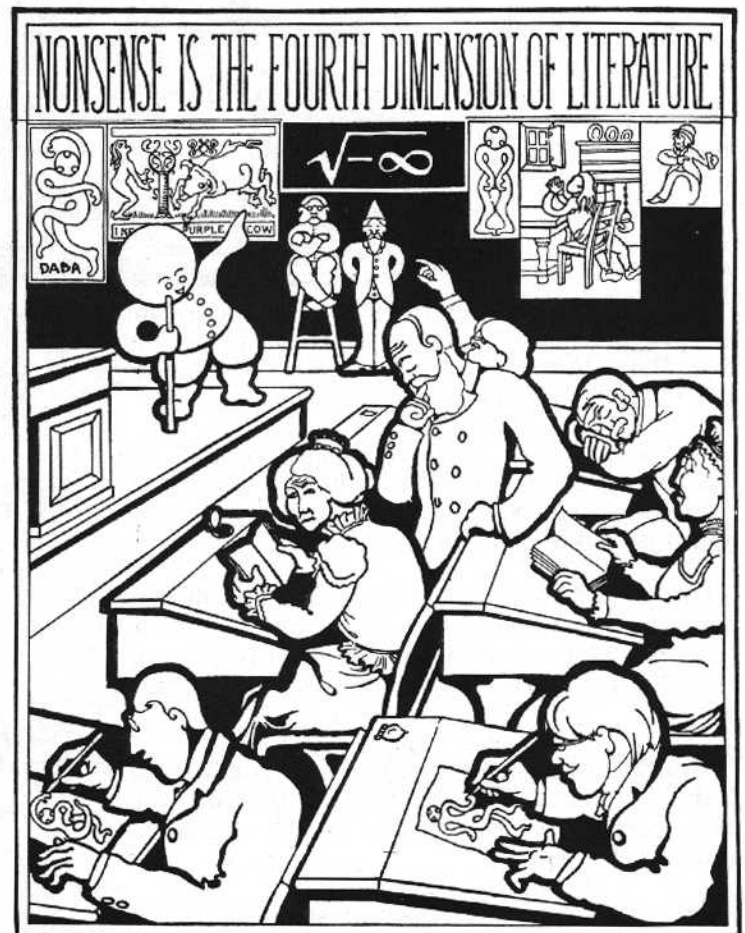

THE NONSENSE SCHOOL

LEARNING



BY
DAVID GRAHAM

F.U.N.E. Women's Catalogue

Learning is the process of building up redundancy in your brain-body's circuits about bits of information. This is true both for learning skills and learning broad intellectual generalizations.

Learning is the process of organizing and reorganizing what's already in your head—and giving it names. Also what's in your body. Learning is becoming conscious of your self.

Like sensing, learning occurs panoramically. Your ear lobe, your pancreas and your little finger, left hand, are all involved in learning. Your brain is only part of your learning system. You are a learning thing.

You can choose a great deal of what you will learn and what you won't learn. Then again, you won't have much choice about a lot of things you learn—and don't learn.

To some extent, those learning abilities you don't use will atrophy. Not much is known about the subject. The Hopi Indians of the Southwest believe you have a door at the top of your head which enables

you to communicate with God. But if you don't use it starting very young and keep using it, the door will close and you won't be able to open it again.

Learning is what you do for yourself. It's all up to you.

Information is free.

Schools

Much has been written about education and why schools aren't working any more. I would only be adding to the pollution problem by writing more about the standard educational issues.

We all know—or can find out if we look closely enough—that our educational system has pretty much collapsed, that the people in the system are becoming increasingly aware of the fact, that almost all efforts at "reform" have not worked and are not working, and that the educational system is having a crippling effect on *all* people who are involved in it.

One response to the "educational crisis" in the U.S. has been the creation of over 2,000 "free" schools. These schools are organized along radically different lines from the traditional school. There are usually no grades or credits, sometimes a different content, and a much more loosely defined distinction between teacher and student. Every large city, and many smaller ones, around the country now have free schools. Each year more and more young people are turning to them rather than face the boredom and tediousness of the regular school program. The public educational system sometimes welcomes free schools, sometimes opposes them.

Even with this tremendous growth rate . . . and every indication that it will continue . . . some people in the free school movement have begun to question what they're up to. Some have come to the conclusion that it is the idea of school itself that is bringing on the present crisis. They are talking seriously about the "de-schooling" of society.

The best explanation of this idea came from a friend of mine. He said that the more a free school becomes a good school, the less it becomes a school. And the more it becomes a community. I think he would add that there are very few of these around.

My own experience as a staff member and the director of a free school during the past year has made this pretty clear to me. I think I have a few insights as to why.

A major assumption of the education system is that people are sick. They need a tonic—called education. A walk-in clinic is created where the tonic gets administered. A patient's progress gets evaluated every so often, and when he's "well" (educated) he is released.



One of the neat things about the clinic is that most of the "therapists" don't even realize that they are therapists. Thus they also are patients receiving treatment. A nice circle game.

Most of the free schools have the same old assumption. They still think people need treatment. The only change is that they don't evaluate the patient's progress in the same way. And the chief effect of that change is to disorient people. They expect someone to tell them what to do. And no one does.

The few schools that are working toward community aren't having much success. One reason is obvious. It has to do with common assumptions. The word school implies a place where a lot of different things are going on—all supposed to be generating "learning". Quite often, so many things are going on that it's impossible to get an idea about what the group is doing, what it wants to do, or how it will grow. Many school groups have broken up over just this question.

At schools, NOTHING can happen because EVERYTHING can happen.

Many of us grew up with this attitude. School is a place where you go not to do anything. In the old system the avalanche of trivia makes the point. In the new one it's people's ideas about what they will do at school and about what the school will do for them.

Community: a group that shares a set of common assumptions. I don't see how that can happen in a school. Free or not.

Alternatives? There are some around.

One good idea: Learning centers could be established all over the country. Anyone would have access to them. They could be used to gather (and generate) information in any area. The necessary technology already exists . . . but technology alone isn't enough. Centers would have to be extensions of living communities, dealing with the things that are important to the communities. Ideally they would be located on a neighborhood scale.

Learning centers aren't just going to happen. Many current institutions would have to change. Family, government, business. . . .

A mother of five told me she liked the idea but that it would never work. Too many parents want to get rid of their children. This is a statement on the nuclear family.

One way of moving in a positive direction would be to establish sets of "institutes" (new word needed) organized along fairly specific lines. (e.g. man/man, man/society, etc.) These could replace free schools. They could be places where people would work together on interests vital to them.

Another short-term alternative would be to allow free travel to young people and set up hostels where travelers could stay.

I'm sure there are other possibilities.

The Community Center for Television Production is a media access organization working in conjunction with the Experimental Television Center, SUNY at Binghamton. We are funded by the New York State Council on the Arts and are cooperating with WSKG TV Channel 46, Binghamton. The Center gives the people of the Triple Cities area access to portable videotape television equipment. This means that individuals and groups in this area may produce television. For example, a high school student interested in the creative potential of tv can spend time at the Center working with video artists. A citizens' group trying to communicate and reinforce a political position or opinion can further its distribution of information through this Center. A governmental department trying to communicate more effectively with the community by giving specific answers to questions is welcome. Anyone who just wants to experiment with tv can use what we have to discover what he can do with television.

ACCESS. Access to communications media (tv, radio, etc.) should not be as restrictive as it is . . . Decentralization of the television medium is a must if a community is to have a "voice" that mirrors its diversity and varying opinions . . . A community where only a few have access to tv is intolerable. TV literacy is necessary.

COMMUNITY AS STUDIO. The community can become a studio because half inch videotape equipment is portable, easy to operate, and relatively inexpensive . . . and you don't need special lighting and technical staffs who operate and care for the hardware. The result is that tv made along those lines will get across more about real people in actual community situations rather than media personalities . . . Dispersing tv production capability throughout a community is holding a mirror up to the community so it can see itself. Through it, communication takes place . . . A community is made of people. The buildings, the money, the cars, and all the other hardware are a supportive technology that may get the community going, but cannot sustain it apart from the people . . . We want more direct communication. That means communication that is not sifted by established tv so only the high points—excitement—are available.

Besides providing ½" videotape equipment for people making their own television, the "Community Center for Television Production" will be a center for talking about what is being made. In this sense, the Center is more than an organization providing hardware. It is also a center for tv education and study . . . People are encouraged to explore.



The Community Center for Television Production
164 Court Street, Binghamton, N.Y. 607/723-9509
Ralph Hocking, Ken Dominick

photo: Hector Lopez, Block of Seventh Street

The following are excerpts from a video tape we made this summer at an Alternate Education Conference held by Phil Yenawine of the Metropolitan Museum of Art which has sponsored a number of video workshops (among a vast array of educational projects) for junior high and high school students. The purpose of the gathering was to figure out how the Met could become a more relevant place for kids to come to.

by Dean & Dudley, RAINDANCE

Nancy Russel, the bookbinder: "Because I'm a very verbal person, I'm lately coming to—what happens to you for which there are no words? We've not had any problem at all describing it verbally, but I know now, and I've become twice as free as I was ten years ago since I have learned that the name is not the thing. This is what I would hope would happen if you were doing any kind of sensitivity training with kids who don't know how to say what they feel yet, that it's important to teach them specifically how to say what they mean . . . I'd call it communications (training) . . .

"The education process so often is making you believe that until you have said a thing, it doesn't exist, and making a wider and wider gap between what you say and what you feel, *and teaching you, bringing you to the point where you can say everything, and feel nothing, and then you are considered educated.* The biggest difference in my mind between educated and uneducated people is vocabulary size. And educated people are not one bit better able to cope with reality than uneducated people. But most educated people consider themselves superior and most uneducated people believe that educated people are superior to them. And the greatest difference is vocabulary size. It's not valid."

Jack Robertson: "These alternatives which you are thinking about doing, it seems to me they have to be different from that old institution. That is if you look back at the sickness in that old one, you can learn what not to do. I see them pretty much as jails. If you haven't seen Weisman's film 'High School' I'd recommend you look at that. Because you can see that some of those teachers like those jails . . . We've got to create alternatives. Some people here are really into that. Far from being pessimistic, I'm personally more excited at the present moment than anything in my life (and I've been in this for a long time), and that's the truth! That other institution is so sick, but some of the things that are coming up from the bottom are healthy . . . The seeds of something new are here. The old machinery has broken down. The old system (meaning the great big system in N.Y.C.) really can't help us very much so you really are forced back on your own efforts. This time education will almost have to be created from the bottom up or it won't work. With the students, the teachers who want to do it, the parents who want their kids in something like that. This time it will have to come that way or it won't come."

We have to get out of those buildings. I learned that out there in Bedford Stuyvesant. So much sickness in the buildings, all over the walls and floors, in the lockers, in everything, in their attitudes that go with it. You almost

have to get out of the schools to get healthy. You have to get out of the schools also because learning as I see it has an awful lot to do with making choices and then following through on those choices. The range of choices inside the school building is just too narrow. What can you decide inside that building? You have to get out and I see the big function of those buildings is going to be making meaning out of the experience that happened some place else. Education is really the reconstruction of experience. That is the way I've learned almost everything in my life . . . The way to change it is to change a piece of it, to take this program and this one, draw away off the major system and create new alternatives and keep creating them. That's all."

Student: "I know that the kids in our free school are not going to want to come to the museum to have a curator lecture to them on Egyptology for three hours writing hieroglyphics on the blackboard. They want something more alive. We could possibly get that at our own school."

Melanie Barron: "It's a wonderful place for kids to have a good positive experience and they don't have to come out wanting to be hired for the job which they were exposed to. But they definitely belong here with every adult that's walking around here doing a job . . . There's somebody taking care of those plants. There's something to be learned, even for an hour a week walking around with a guy who's got these wonderful things growing. The kid is not necessarily going to grow up and be a botanist, but he will have a nice experience. He may meet a nice man who will spend some time talking to him."

Student: "You can't force a student to get into the fact that they have to tell you exactly what they feel about something, pictures let's say. Many students don't come here just to think about the pictures or what the painter was feeling. They just come to see and have some fun. But they don't find any fun over here because the whole place is covered with paintings."

Student: (commenting on a sensitivity session where they acted out some of the paintings) "I hated museums and I still do, it's just that I find something that, even though it's not as deep as some people would like, at least I get something out of it. I don't know what, but I enjoy looking at pictures and doing something like what I just did now."

Woman from the Clinton Project: "Kids from 12, 13, 14 have a certain attention span and after that, forget it. They are tuned out . . . An activity that they can do, that's the big thing. Listening after a while means nothing to them."

Melanie Baron: "Doing the very best you can teaching straight lecture-wise doesn't work in the schools and it's not going to work in the museum either."

Student: "You've got to have the students become aware somehow of the possibilities, that this, this, and this are available to do, that you can if you want to. But you can't just ask us what we want to learn. You've got to have some kind of direction."

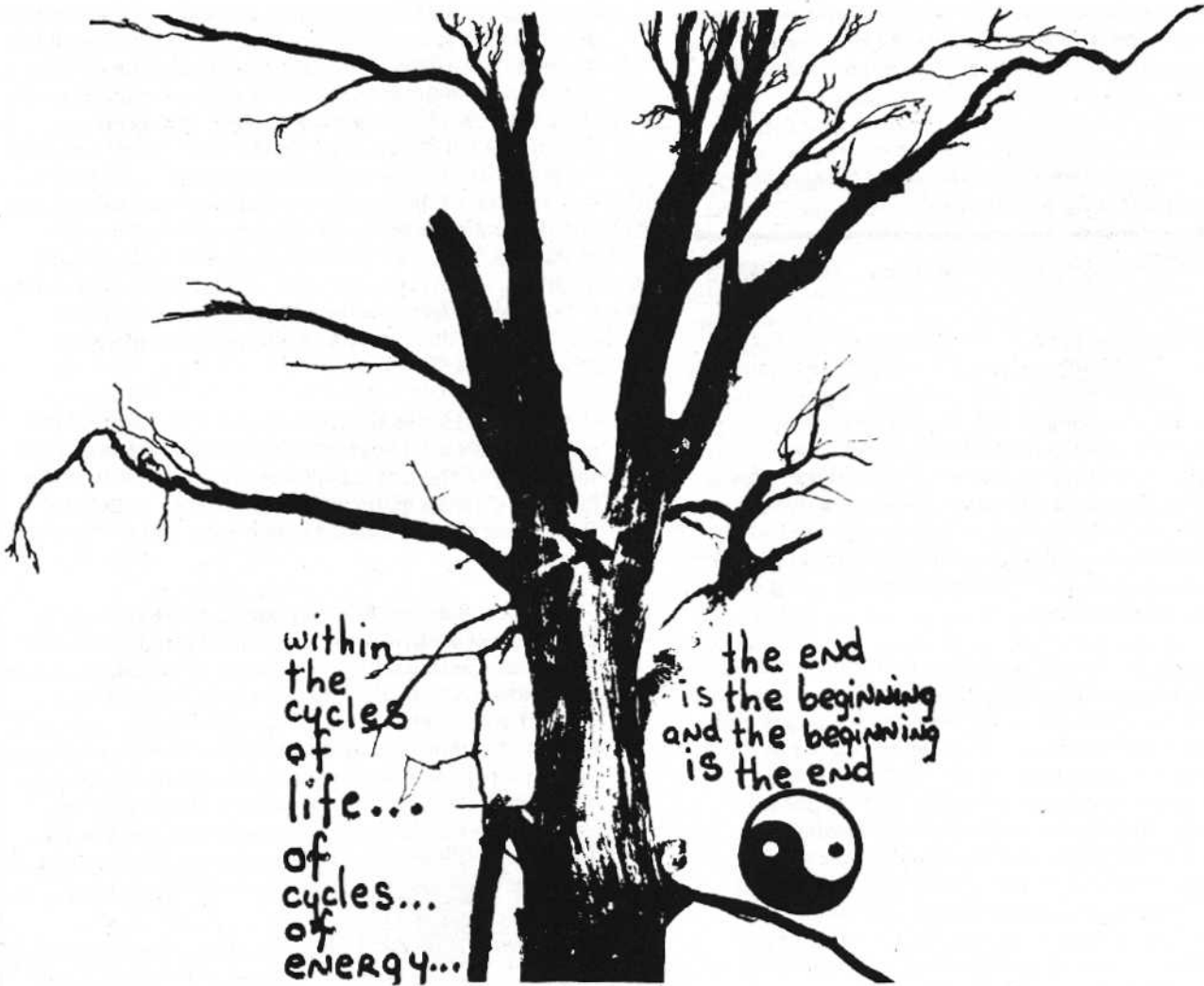

within
the
cycles
of
life...
of
cycles...
of
energy...

the end
is the beginning
and the beginning
is the end



We are what we believe and are much safer when we know.

religions, psychology, philosophies, ontology, cybernetics, mysticism, astrology, education, self-hypnosis, occultism, and politics

There is only energy
Within the context of energy vibes.
Change is the only permanent condition
Within the context of change,
the image, the symbol, is the
organizing principle of conceptual identity.
Within the context
of images and symbols...

ICONICS = science-knowledge of images
and since consciousness is the product of
images and symbols of associative feelings
with knowledge-wisdom as the composite
understanding of these... ICONICS becomes:
the science of knowing, the knowledge of images
the imagination of reality, the realization of actuality
the actual nature of consciousness...
which is simply a feedback mechanism of
associative inputs-intuits-ingrams-constructs of
patterned knowing... i.e. of images and symbols

THE ICON IS THE ORGANIZING PRINCIPLE OF ESSENTIAL CONCEPTUAL IDENTITY

It has been said that a picture is worth a
thousand words; the icon simplifies to a
meaningful few. It has also been said that
man's created identity is of the image
of **God-Krishna-Om**... and that this image,
this organizational principle, this harmonious
orientation within space and time is man's
self-concept... his **self-image**.
Man thinks... and therefore is...
what he thinks... **HE IS.**

It's not where we are, but what we do where we are.
in this ocean of vibrational actuality
which we subjugate as reality.
It's not where we look, but what we look for
for we see-know what we want to see...
and can do as much as we know-see.
When we look for **BOVD** we encourage **IT**.
When we understand **BOVD** we are... **IT**.
from now to now
Systems designer **F.R.G.**
513-335-8383 ... **I AM**

ogy, cybernetics, mysticism, astrology, education, self-hypnosis, occultism, and politics

portable video: the natural medium



photo: Dudley

Life Processes, a process revolution

Just what is it anyway about the nature of portable video which makes process its most important product?

(A blessing in disguise). Somehow at a crucial point in time in a highly commercialized, industrialized, mechanized nation, we have become enamoured with a technology for which there is no marketable product. Oh yes, there will be the cassette revolution, and of course cable tv is a possibility, and really, the range of possibilities for its use is infinite—but still—who's buying ½ inch video tapes these days?

With no market in sight, we are at last being forced into using a high tech communications tool as a real aid in extending our capabilities of relating to our fellow man and even in better understanding our own complex selves. Except for a few industry types who use ½ inch video as a "notebook" of ideas for making more realistic automobile commercials, most of the people who become involved with the medium are sincerely interested in developing humanistic uses of the technology. Could be also that most of these people share a feeling that there is a certain beauty in life which is a lot more interesting and honest as information than the inane, if not complete life-negating entertainment and "news" which the networks see fit to sell to their audiences.

Because we are concerned with life as a process, it is

only natural that in the act of taping, the foreplay (as well as the afterplay, instant replay) becomes as important as the orgasm itself. Otherwise, the subject becomes an object, and the cameraman (or woman) becomes a video chauvanist or rip off artist which is most often the case when a big tv or film crew comes into a scene and takes the information and runs.

Portable video, because of its nature, has a built-in safeguard against such tendencies. Even if you're not into passing the camera around and letting your subject/object become a participant in the production and seeing how easy and fun the whole media trip really is, you can at least let him (them) (her) have the experience of seeing himself replayed on a monitor after the fact, since no one should be denied the realization that he is equal to any superstar the establishment decides to hype up. Anyone who has ever taken his portapak and a portable monitor into the street and just let the tape roll, knows the power this little machine has in making things happen—i.e., people actually begin talking to you! (which doesn't always occur so easily if you happen to look a little wierd to them). They also start talking to each other and in their amusement with seeing themselves and their friends on tv, they begin to develop a consciousness that what they have to say does mean something to someone besides themselves and that maybe, if it isn't too much to hope, *they can begin to regain something long ago lost to them in a world of giant corporate power structures, and that is the feeling of having control over their own destiny.*



Whether we're into it or not, the often logical result of process video is some sort of product, certainly nothing to fear. An enhancement in fact, of that very process which so involves us. With video, we end up with a taped record of time past, a magnetic memory of our real life experiences to be stored in our memory bank (on the shelf as so many video tapes sit!) or to be shared with others as an enrichment to their own realm of experience. If a tape is intended to be shared with people who weren't there at the time of the taping, its technical coherence is as important as its content and its feeling of flow. For sure, the amount of energy put into the making of something *is* reflected in the final result. How many times though, have we watched a tape, well able to realize the nature of the situation, even wishing we could have been there, but somehow not really being able to share the fullness of the experience because the cameraman was looking the wrong way (up at the ceiling or down at the floor), couldn't get it together to focus or steady the camera, and in general just wasn't in tune with his instrument or his environment. We do cry out for an organic camera design which more nearly duplicates our personal vision (see RS III, p. 15, for our suggested camera design), and which is of course lightweight and easy to handle without undue concentration. But until someone builds one, we have to decide if we are indeed making tapes as a form of communication. If so, we must train our audio-visual vision to tune in to that space in time and take from it those elements which most succinctly communicate the nature of the experience we have participated in. Natural rhythms call to us. Whether we edit in the camera or via transfer, we are still applying conscious order to our experience and in so doing we must consider the effect of timing and sequence, as well as audio and visual content. (As a tape and time saver, turn off the camera when there ceases to be anything relevant going on) Because we lose energy in the transfer from real time to recorded time, the electro-magnetic product has to be that much more together in order to involve us, the viewer. Artistic framing *can* come with conscious vision.

I do want to share your experiences but since I am not addicted to the blue tube, I need to be stimulated by it before I will sit for it. So all we ask is that a tape be interesting, informative, and entertaining, and that it show us as closely as one mind can see, just what really happened. Take us on a journey, but don't bore us. That we can do ourselves by flipping to another channel . . . Natural tv, however, comes from your own heartfelt experience, and that I would hope, is a world of soulfull sensitivity, not of sensationalism as we are led to believe by the media minded marketers of the 6 o'clock news.

*Getting it around. Networking.
Sharing the information/experience*

"Send us a tape and we'll send you one back, no shit."

It is happening. Not in a flood of video tapes certainly, but slowly and from a core of people who are really into the experience of this life, there is emerging a decentralized network of shared experience. We're learning about eachother. We know we're a part of a growing col-

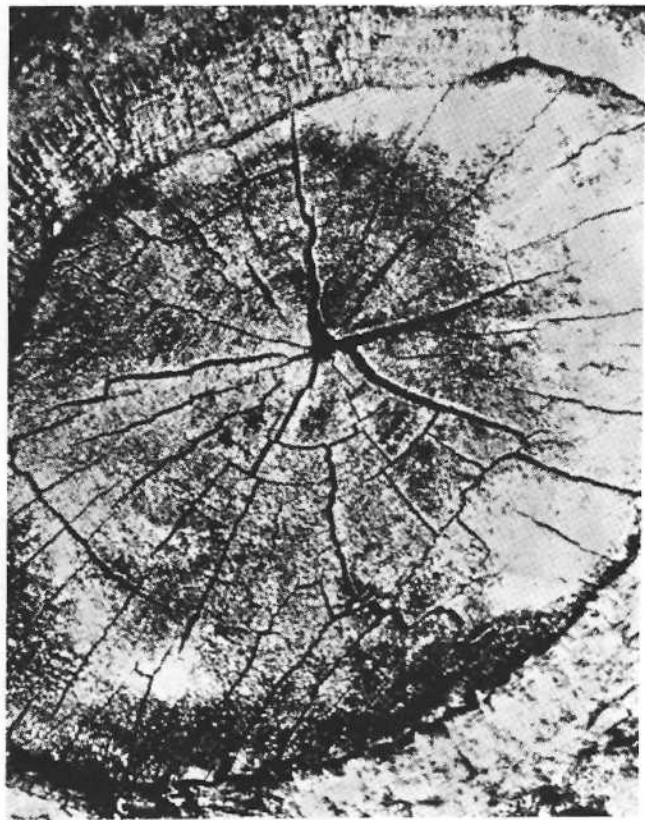

photo: Dean

lective consciousness, sharing in a struggle to alter the course of our farfetched futures, and we know we are not alone.

Still though, we want to know more. Our fancy has raced ahead of the technology and we imagine a system as functional as the telephone, carrying its audio-visual messages of experience (time, life, space) truly relevant to our survival on this planet. But now is now, and we still get responses like . . . "we've only had our portapak a few months now, and we haven't gotten anything together yet." And then we never hear from them. Of course there is no reason for a network if we have nothing to share, but really, we just want to know who you are and what you're into, even what your space looks like, and what your neighbors have to say. After all, it is real live people who make up the infinite diversity of human forms and only by tapping this vast range of life forces can we begin to realize the potential of our evolutionary course (here and now!).

In this issue we are publishing a comprehensive directory of all the people we know who are working in video (the "other networks to plug into" section in this and past issues can also be used as a reference in hooking up with people). Get in touch with each other! We have found that our close friendships with other video groups have proven invaluable, not just in the sharing of certain technical information which we all need so desperately, but also in giving us a more diverse base of experience from which to apply our knowledge. In this way, video becomes an impetus for people getting together with themselves and eachother, rather than keeping them as passive receivers. Tape exchanges and information exchange imply feedback and learning becomes a two-way vehicle towards communication.

We are moving away from the concept of teacher as an authority figure, and we approach a more organic system where we all have information to share with each other and our community once again becomes the place of learning, rather than the pseudo schools and establishment media which have heretofore hyped our educational environment. Thus we strive for tapes which promote human interaction and growth.

We would also encourage the showing of tapes to as many people, as often as possible, still believing that video is most effectively relevant to small groups. Getting your tapes shown on cable tv is important also since of course you can thereby expose many more people to humanistic ways of viewing the world, but still, the medium lacks feedback and two-way exchange. On the other hand, setting up a community viewing space seems to satisfy many more of our needs for personal contact and in the long run does more to turn people on than any kind of mass media so far.

We had a really positive experience last year when we set up a viewing space in our New York City loft and showed tapes to the public every Saturday night. Probably one of the reasons it was so successful, besides the fact that the tapes took people places they had never been and introduced them to people they had never known, was the fact that we tried to create an environ-

ment that was as comfortable and natural as your own living room. We used several monitors, all showing the same tape (which isn't to say that several relevant tapes couldn't have been shown simultaneously with conscious mixing of audio tracks). Seating was in small comfortable groups, each around one or two tv's, and relaxed conversation among the viewers occurred as a result. The space resembled a landscape. Seating platforms on different levels, monitors piled up on top of each other, cushions on the floor, one big video picnic under a giant parachute sky. The tapes were a collection of the best sequences from our own archive and from those of other video groups (Video Freex, Peoples Video Theater, Media Access, TVX in London) so the resulting experience was a life trip of considerable diversity.

Diversity. It's almost a dirty word in a nation founded on principles of equality (a concept which has somehow been misconstrued to mean homogeneity.) We are confronted with a centralized information source which tries to push its constituency into a common mold and we struggle to be free of it. We are all unique individuals and in a world of joy there is room for diversity. A healthy planet encourages it. We do in fact strive for it. And a de-centralized communications system which allows free expression to all, embraces it.

Dudley

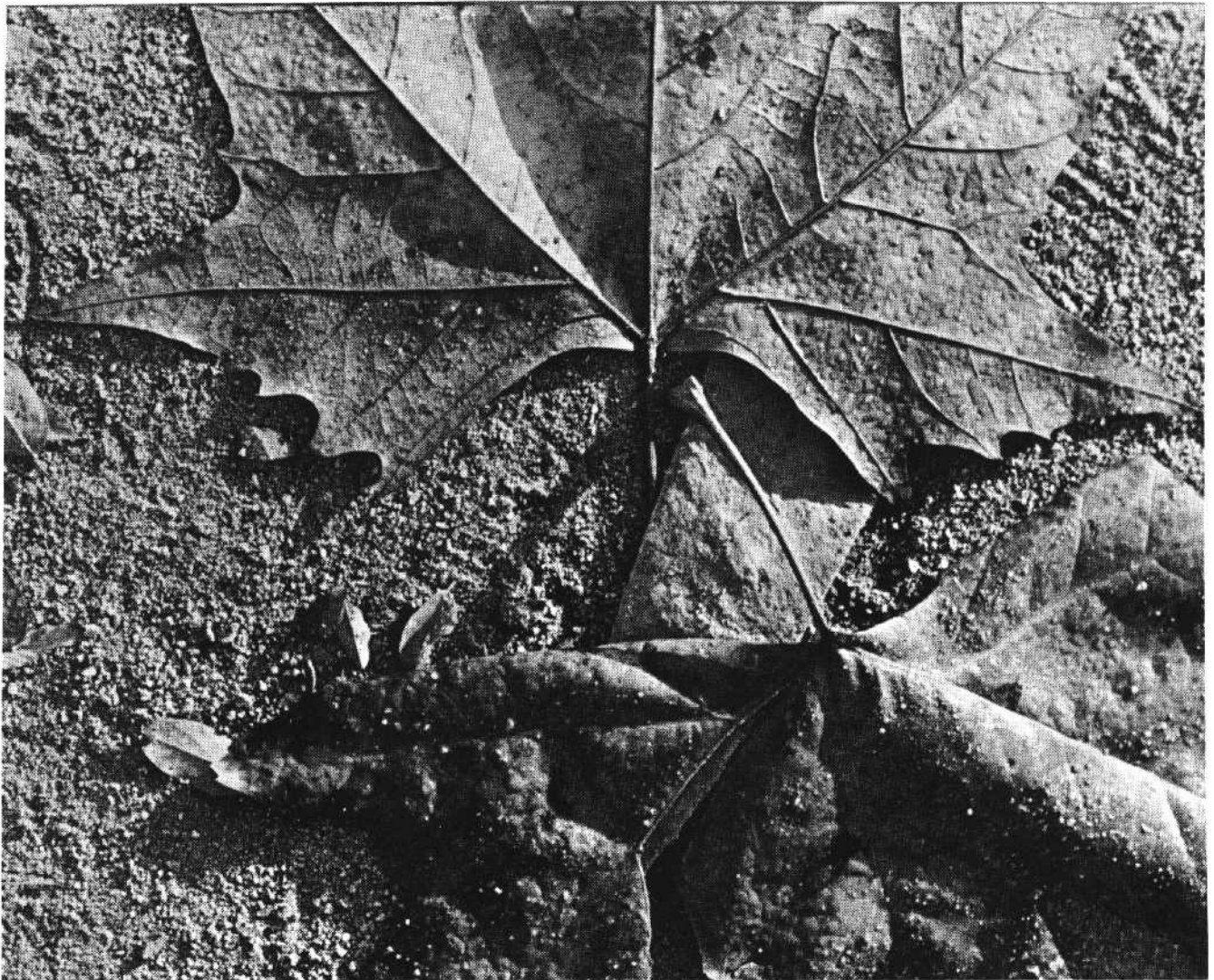

photo: Russell Dian

HOMESKIN

Video Pony Express

Outside Boulder, Colorado is a former open-hole gold mining region so pocked with unmarked abysmal pits that an entire mountain was recently condemned, like a slum building with a caving foundation, and leveled with dynamite and bulldozers. Core-ravaged ghost of the Golden West! It's a place where no one is sure whether a rock lies in a natural position or was spat out by hydraulic hoses. Too many mining blasts have rocked the cliffs to determine whether their faces are original. It's a spot deserted of Indian spirits and gray with the stayed-poor phantoms of miners.

New "planetarian" communities have been nesting here in the last few years. Life-actors of continental resurrection, self-conscious agents of terrestrial repair. Dirt roads trailing off the hardtop reveal pockets of small domes, rebuilt mining shacks, new houses of recycled lumber, and restored log cabins. The settlements of Ward, Summerville and Gold Hill have tripled and quadrupled in population. Ghost towns turned freak towns.

We chose a campsite central to the new communities but on land well outside any of them. Our purpose was to provide an occasion to bring communities together, not to glom onto their scenes. This was going to be the first delivery of video mail on our West-to-East run.

Homeskin letters are videotaped introductions between new communities, collectives, families, and tribes living on the land. They are electrical impulses creating their own circuits.

Planetary consciousness, the idea that any spot on the planet is part of the whole, and that acts and ends can be undertaken for planetary rather than national, ideological, or social-hierarchical reasons, is the uniting factor between new communities.

Trucking around the hills—"the domes", Ward, Summerville—we were exposed to paranoia attending the Boulder County Sheriff's recent invasion of the new hillfolks. In the classic pre-election pattern, he had busted four hundred people the week before for hitch-hiking, camping, "walking on the wrong side of the road"—every small-time bullshit excuse that would discourage massive occupation of the hills by longhairs. It's only taken a hundred years for the Indians to become friendlies and the law men to become "the hostiles".

Our tapes of Canadian Doukhobors and the Cali-

fornia Sierra tribe were acknowledged but without a feeling of continuity with each other. The circuit that needed to be created was among themselves.

Ward's unofficial mayor, Charley Dagleman, was persuaded to make a "tour" tape of Ward showing voluntary community building projects, garbage collection, cafe, and fire department—all freak projects. He interviewed Betsy at the Post Office, tore down some "Wanted" posters, and told how feds come and wait for people to pick up suspected dope packages. Ward's marshal had been forced to remain inside under house arrest while the Boulder County Sheriff raided the town. Charley explained that this was necessary because otherwise the marshal might have stopped the sheriff, and proudly pointed out the marshal's outhouse.

We then made a tape of "the domes" and recorded a first-hand dope arrest witness from Summerville.

The town of Ward offered to host a video showing in their main street. Not *along* the street, *in* the street! Everyone from the communities that had been taped was invited to come to Ward to see their own tape and meet nearby hillfolk. It was an incredible occasion! A keg of beer on the back of a pickup truck, cars parked to block the street at both ends, barbecued lamb, Chinese New Year's decorations on the main buildings, banjos and guitars. A strong positive number in the face of outfront hick-politick harassments. Neighboring communities dug their planetary stance for the first time together! The circuit exists now.

* * * * *

What's the difference between video *mail* and videotape?

Camera, VTR, equipment-mirage in general are not the *property* of their carriers, toters, Pony Express riders. The whole video event can be shared totally. Camera work, sound, narration *should* be shared. Ward's "mayor" did visuals and narrated our tour. He made his own letter. We drove the truck.

Video mail belongs to the senders and receivers. We delivered the War letter to people from Libre, Colorado in a NYC loft months later when we were all passing through.

Peter and Judy Berg



*Video Wedding at the Freex
Curtis and Cy*

photo: Ann Arlen



Feedback

VIDEOFREEX/MEDIA BUS at MAPLE TREE FARM

The adventures of living and working together with video continue. We've been in the mountains for a half a year now and we find it very comfortable and an easier place to work. We do sometimes feel a bit out of touch and hope that friends and colleagues keep contact...please put us on your mailing lists and if you would like to receive a copy of our Maple Tree Farm Report (which comes out every so often) please write to us.

We have been doing a lot of video. The Media Bus program has visited 30 or so communities in New York State and we have begun to expand the program outside the state, especially to universities and free schools... we are seeking funds to do this. We have also begun to apply video to other fields especially to architecture and environmental design. We've been working with a group of environmentalists called S.I.T.E. as well as several architectural firms. We have also started to interface with computer technology...some people from Meta Information Systems in New York City seem interested in investing computer time and human energy in storing data about video people and video tapes in an information bank... this relationship is just beginning but it looks interesting and of course the implications of a computer/video relationship are grand indeed...aaah, spaceship earth, what's in store for you!

The New Age Communications Manual mentioned in the last Radical Software is almost completed. It's a technical manual for people who are using 1/2 inch videotape equipment with information for people who have little knowledge of the insides of the equipment and for people who are more advanced in their knowledge of electronics. It should be ready in late Winter or early Spring, 1972.

We've also been thinking a lot about Television. We've been watching the tube and have been making TV shows. Our shows are on both cable stations in Manhattan and have been broadcast through the air in Utica, New York.. We are interested in showing our material on TV in people's homes. We are pursuing this by editing show tapes and by contacting cable and broadcast stations. Perhaps someday we'll be known as the Television Freaks.

In the meantime, there will be Videofreex traveling in the East, California, Europe and Israel. We hope that anyone who would like us to visit them with or without our Media Bus, or would like to receive our newsletter, or would like to receive our show tapes would contact us at Maple Tree Farm, Lanesville, New York, 12450.

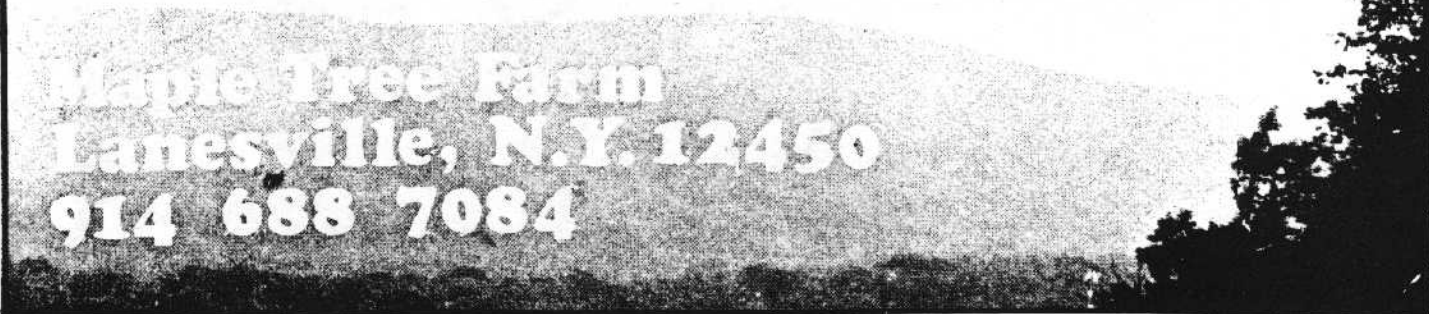

Maple Tree Farm
Lanesville, N.Y. 12450
914 688 7084

APRIL 29 MAY 7

APRIL 29

ALL THE VIDEOFREEA EXCEPT NANCY, BART, CURTISS AND SKIP WENT TO D.C. TODAY. I ALSO MAILED PHYLLIS HER CHECK.

APRIL 30

I HELP OUT WHEN I CAN. I KEEP THE TRUCK NEAT. I DON'T LOOK FOR NEW RELATIONSHIPS. IT'S HARD FOR ME TO RELATE TO ALL THIS. DAVID IS ANXIOUS TO PLUG IN—MAKE A BIG NOISE—BE A PART. HE TRIES TOO HARD. WE'RE A PART BECAUSE WE'RE HERE. WHAT ELSE? CAROL IS SLEEPING IN THE BUS. THE GENERATOR IS NOISY. IT IS LATE AFTERNOON. PARRY AND CHUCK HAVE BEEN WORKING HARD, TRYING TO GET THE TRANSMITTER GOING. I'M NOT SURE IT ISN'T A WASTE OF TIME. IF WE GET A BEAR PROJECTION SCREEN TOGETHER WE WILL PROJECT TONITE. I'M RETREATING FROM CONTACT AS USUAL.

MAY 1

LAST NITE WE ALL SHORT-CIRCUITED. A SPASM OF SELF-CRITICISM WHICH GRABS US AT CRUCIAL MOMENTS. HERE IS WHAT IT WAS—WE CAME TO THIS EVENT BASICALLY UNPREPARED. WE WERE NOT PREPARED TO CAMP OUT OR TO FUNCTION AS PART OF THE SYSTEM. PARRY AND CHUCK SPENT YESTERDAY TRYING TO GET THE TRANSMITTER GOING. BUT IF THEY HAD SUCCEEDED THERE WERE STILL ONLY TWO RECEIVERS IN THE PARK—BOTH BROUGHT BY US. DAVID SPENT YESTERDAY TRYING TO THINK OF A WAY TO PLUG INTO THE MAYDAY SOUND SYSTEM, BUT WE HAD MADE NO ADVANCE ARRANGEMENTS TO MAKE THAT HAPPEN. THE PLACE WE WERE STAYING LEFT PARRY AND CAROL WITH BAD VIBES. THEY SLEPT ON THE BUS. IT IS CONTINUOUSLY FRUSTRATING. THE ONE THING WE DID WAS TAPE THE D.C. POLICE PUBLIC RELATIONS MAN IN HIS OFFICE. HE GAVE US STOCK ANSWERS. THEY GLAD-HANDED US, THOUGH. EVERY COP WHO WENT BY SMILED AND CALLED US "GENTLEMEN". CURTISS FOUND US LAST NITE. TODAY WE ALL GOT UP LATE. THOUGHT MAYBE I'D GO TO THE NATIONAL GALLERY.

I DID GO TO THE NATIONAL GALLERY. I WAS GOING TO GO TO THE CONGRAN ALSO—BUT IT WAS CLOSED ON ACCOUNT OF THE RIOT. I LEFT THE N.G. AT 4:30. I ATE SOMETHING POISONOUS AT THEIR CAFETERIA. I WENT TO THE MUSEUM OF SCIENCE AND TECHNOLOGY NEXT DOOR. IT WAS FULL OF CHILDREN. MODEL T FORDS, CUPS AND UNIFORMS, OLD TOOLS. ALL THE THINGS KIDS LIKE. NOW I'M SITTING IN THE PARK OUTSIDE. A COP IS COMING. HIS WALKIE-TALKIE SOVACKING. HE'S LOOKING ME OVER.

WHEN I GOT BACK TO HILTZER ST. BOSTON NEWSREEL WAS THERE. THEY GAVE ME A CAN OF COLT 45 AND I SAT WITH THEM A WHILE. THE MAYDAY VIDEO PEOPLE ARE VIBING ABOUT NBC SINCE PARRY, CAROL AND I TOLD THEM OF OUR EXPERIENCES WITH CBS. I'M EATING IN THE NAN-KING ON 'P' ST.

MAY 2

LAST NITE I CONNECTED WITH PARRY, CAROL, CHUCK AND ANN. WE STAYED OUT ON G-LOVER DRIVEWAY. IN THE MORNING WE WENT TO THE LAND AND I WAS ARRESTED. I SPENT THE DAY IN JAIL AND WAS RELEASED AT 11 PM OR SO. I MADE A TAPE IN JAIL. NOW DAVID IS DETERMINED TO BE ARRESTED. I WAS LUCKY, OF COURSE, TO

BE ARRESTED BY A POLICEMAN IN GOOD HUMOR AND LET OUT AFTER A FEW HOURS. DAVID, NO DOUBT, WILL BE BEATEN TO A PULP AND THROWN IN THE CAN FOR WEEKS. I DON'T MUCH WANT TO GO BACK.

MAY 3

I JUST WITNESSED THE MOST INCREDIBLE PRESS CONFERENCE I HAVE EVER SEEN. IT WAS AT THE MAYDAY OFFICES. I WENT THERE WITH TWO PEOPLE FROM MAYDAY VIDEO TO SET UP A PLAYBACK SYSTEM FOR THEM. THE STRAIGHT PRESS CAME IN SCEPTICAL ONLY, BUT THEY LEFT IN A HOSTILE MOOD. THE WAY THE CONFERENCE WAS CONDUCTED IT WAS UNDERSTANDABLE. THE MAYDAY PEOPLE INFURIATED THE PRESS BECAUSE THEY USED WORDS CYNICALLY. WORDS ARE THE MOST IMPORTANT THINGS IN THE WORLD TO REPORTERS. I GUESS THEY'RE OF SECONDARY IMPORTANCE TO US. WHATEVER WE ARGUE WITH THEM WE GET DESTROYED. THEY ARE BETTER ARGUERS THAN WE. WE'LL NEVER BEAT THEM AT TALKING. BEFORE WE LEFT WE ATTENDED A MEETING OF REGIONAL REPRESENTATIVES. IT WAS A HEAVY MEETING. THEY WERE CONFRONTED WITH THE PROBLEM OF KEEPING THEIR PEOPLE ON THE STREET IN THE FACE OF 7000 OR SO ARRESTS. AS WERE THERE THE RUMOR STARTED CIRCULATING THAT WE WERE ABOUT TO BE BUSTED. THE POLICE ACTUALLY SEEMED TO BE GATHERING OUTSIDE SO WE HUSTLED OUR EQUIPMENT DOWN THE ELEVATOR AND INTO THE BUS. [THE PEOPLE IN THE LIVING-ROOM SAID THAT THE MAYDAY OFFICES DID GET BUSTED TODAY SO I GUESS IT WASN'T JUST PARANOMIA. PARANOMIA IS A TOOL THAT KEEPS US ALIVE AT TIMES. IF WE HAD NOT RESPONDED TO PARANOMIA TODAY WE WOULD HAVE GOTTEN GARBAGED AND ALL OUR EQUIPMENT.] PARENTS ALL SAY THE SAME THINGS AND ALWAYS AT DINNER. WE JUST ATE A FINE MEAL AT BOB QUINN'S PARENTS HOUSE. A DIFFERENT WORLD. ONLY AN HOUR AGO I WAS LIABLE TO BE ARRESTED ANY MINUTE. NOW NO DANGER, A SHOWER, A GOOD SLEEP.

THEY DIDN'T BUST THE MAYDAY OFFICE. JUST PARANOMIA.

MAY 4

RIDING AROUND D.C. IN VW BUSES. THIS IS MY FORTN TODAY. PARRY HAS CREATED A REAL EFFICIENT VIDEO HEADQUARTERS BACK AT HILTZER ST, COMPLETE WITH MAPS, TELEPHONE AND BULLETIN BOARDS. SORT OF LIKE A BUNKER IN WARTIME EUROPE.

MAY 5

LAST NITE I HAD AN ARGUMENT WITH DAVID WHICH RESULTED IN AN OUTLINE OF OUR POSITION VIS A VIS THE STRAIGHT PRESS. I FEEL THAT WE SHOULD HAVE NOTHING TO DO WITH THEM AS IT UNDERMINES OUR COMMITMENT TO AN ALTERNATE STRUCTURE. DAVID FEELS THAT I AM TOO RIGID. SO WE CLASH. WE HAD A LATE NITE VIDEOFREEA MEETING. WE DECIDED THAT WE'D GO ON STRAIGHT TV ONLY IF THEY PUT A CERTAIN AMOUNT OF TIME AT OUR DISPOSAL FOR US TO PROGRAM. CAROL WILL EXPLAIN THIS AT A MAYDAY VIDEO MEETING TONITE. THEY WANT TO BROADCAST—SO THEY ARE SCEPTICAL OF OUR POSITION.

MAY 7

PARRY DID A FAST EDIT OF D.C. MATERIAL. CBS CALLED ABOUT THE JAIL TAPE. PARRY TOLD THEM TO GET LOST. DAVID IS STILL MAD AT ME.

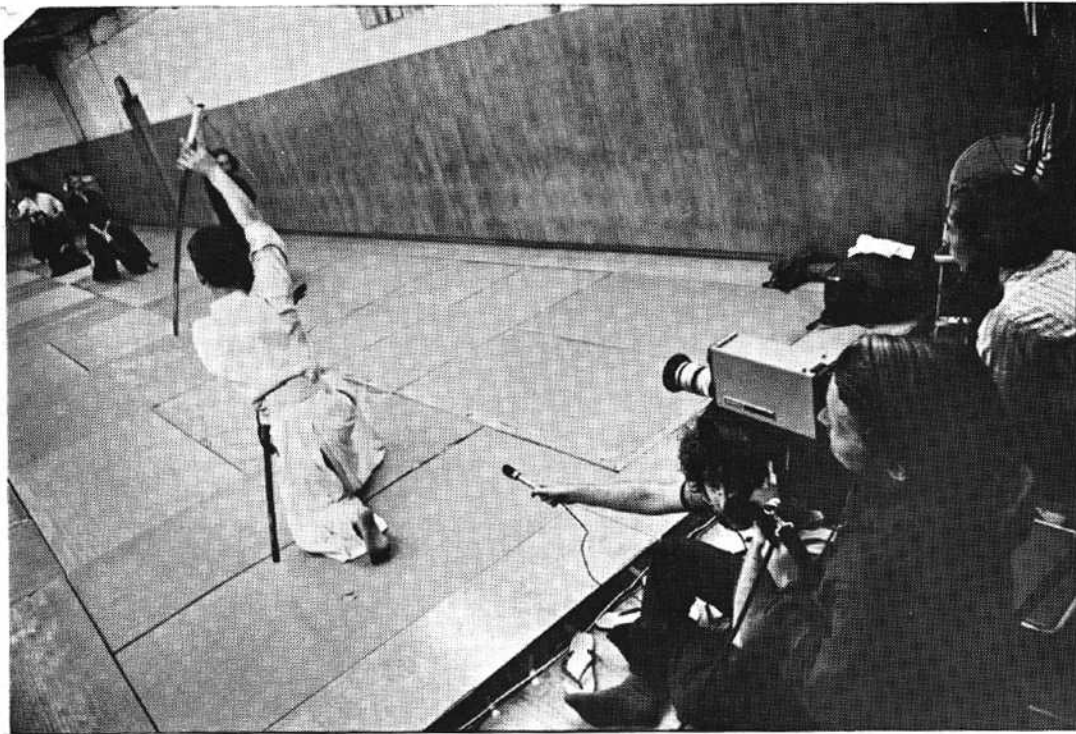

BY JOHN REILLY AND RUDI STERN

Global Village has been in existence since September of 1969. During this period it has pioneered in exploring the medium of video. Global Village has been and is currently involved in the following areas of experimentation.

Global Village Video Workshops and the Experimental Video Center in association with the New School: Two on-going workshops dealing with various aspects of experimental television. (See New School catalogue for descriptions.) An expanded workshop program is being planned for 1972. Documentation regarding the Experimental Center and the educational process involved is being funded by the Rockefeller Foundation in conjunction with the New School.

Global Village Video Resource Center: a non-profit, tax-exempt, educational production and consultation service. This Center has been conducting various projects with an expanding spectrum of community organizations. The New York State Council on the Arts is continuing to fund and thereby partially support the Global Village Video Resource Center. This activity is directly related to the creation of programming for the Public Channels of Cable T.V. in New York City. Since the inception of public channels Global Village has had a weekly program concerned with on-going community projects.

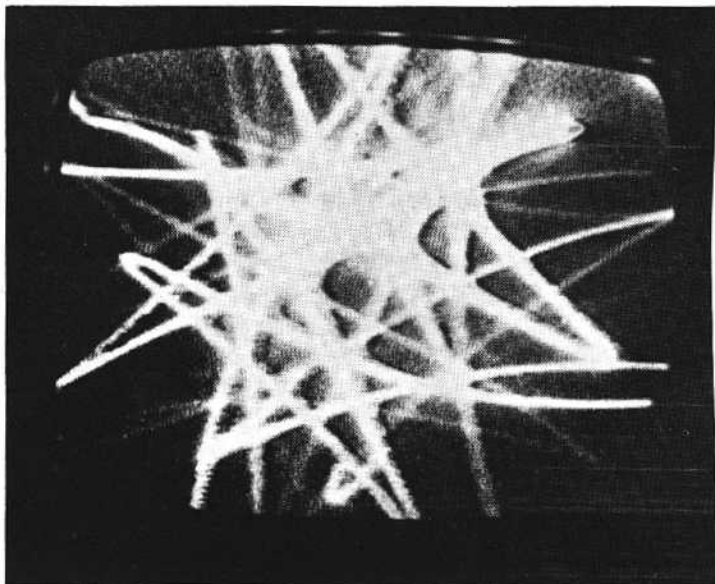

GLOBAL VILLAGE

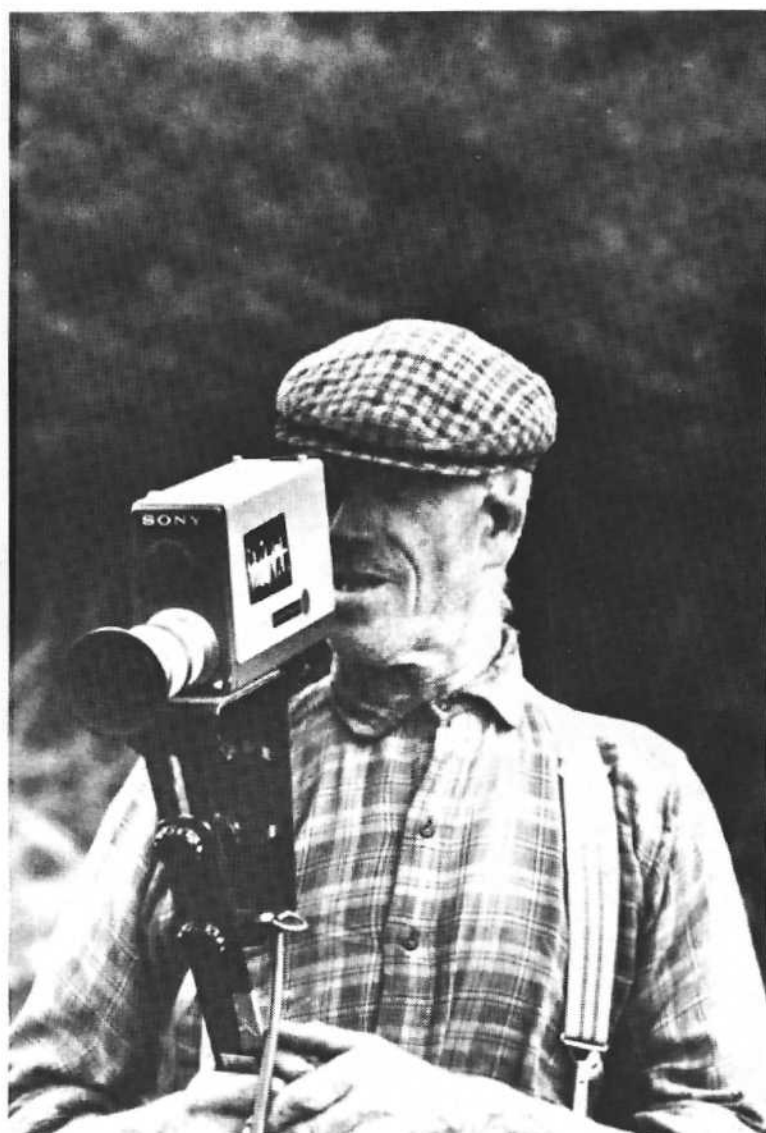

A partial list of community projects to date include the following: Viet Nam Veterans Against the War, National Association for Irish Freedom, Daytop Village, Chelsea Print Project, Ericks Foundation, WBAI, Krishna Consciousness, Gay Activist Alliance, Hospital Audiences Inc., SoHo Artist Assoc., Lower East Side Service Center, Clergy-Layman Concerned, Peoples' Coalition for Peace and Justice, National Conference of Christians and Jews and various programs for the City of New York.

Global Village has also received commissions for extensive projects which go beyond the Resource Center and the Global Village workshop commitments. One such project is a current commission by Joko Productions (John Lennon and Yoko Ono) to do a video/film on the current conflict in Northern Ireland. Among the current projects also underway are a series of video workshops in prisons as well as a series of Video Dialogues between inmates of correctional institutions and guards. This project is being explored in association with the Equal Justice Institute. A continuing series of video seminars and presentations at colleges across the country (i.e. Harvard, UCLA, Goddard, NYU, Pratt, McGill) is also a part of the center's program.

John Reilly and Rudi Stern are currently working on a book entitled *Global Village Video Manual* to be published in the fall of 1972 by St. Martin's Press. This book will cover all aspects of portable television as a cultural, social, educational and artistic resource.

Global Village often presents performances at its studio that are an exploration of the environmental and kinetic resources of 1/2 inch video by regularly scheduled multiple-channel performances.



Photo: Dorothy Todd Hénaut

The following is a report from the Challenge for Change Newsletter published by the National Film Board of Canada (P.O. 6100, Montreal). It is typical of the many media related community activities which the Film Board involves itself in. People interested in using video in community action should get in touch with Dorothy Hénaut, editor, for past issues since their experiences will prove invaluable for anyone wishing to do a similar thing.

Challenge for Change attempts to implicate the communications media in the process of social change . . . The videotape recording project in Saint-Jacques is an attempt to extend to its logical conclusion the conviction that people should participate in shaping their own lives, which means among other things, directing and manipulating the tools of modern communication necessary to gain and exercise that participation.

The Comité des Citoyens de Saint-Jacques, a dynamic citizens organization in one of downtown Montreal's many poor areas, was founded in March 1968 at a public meeting called by a handful of concerned citizens with the help of a community organizer from the Urban Social Redevelopment Project. At the meeting, the citizens agreed that bad health was their most immediate problem. On receiving no help from provincial and civic authorities, the citizens decided that would take the affair into their own hands. They rented an apartment in the area, renovated it themselves, and recruited medical and dental workers who were interested in the idea of a citizen-run community clinic. By October, they opened their clinic five nights a week.

There seemed to be a convergence between the needs and ideas of the Citizen's Committee and those of Challenge for Change and we approached the Committee with the idea of a project exploring the use of videotape recording equipment in community organization. The Committee recognized its potential effectiveness as an

organizing tool, and formed a VTR-film group . . . The broad objectives of the Comité des Citoyens de Saint-Jacques are to work as citizens to gain as much control as possible over their own lives. The main job of the information team to which the VTR group is attached, is to sensitize the inhabitants of the area to their common problems and to communicate the Committee's hope that together they can act to change their situation . . .

We were still floundering around, testing possibilities and uses of the equipment, when the information team proposed a week-long information and organizing campaign for the end of January. The aims of the campaign would be to inform the residents of the community of the existence of the Committee, to stimulate debate on their collective problems, to gain new and active members, and subsequently to decide on new projects . . . This was exactly what the VTR group needed to give it some direction. We proposed to prepare a half-hour program on the problems of the people in the area, which would be shown at the opening of each meeting. Building on the existence of the clinic, the theme of the campaign was, "Why are we sick?". This led to exploring the causes of ill health, bad housing, unemployment, inadequate welfare, sparse recreation facilities, low-grade education, and bad medical care . . .

The VTR group did some interviewing in the streets on the day of the meetings, inviting people to come and see themselves on TV. These tapes were run, unedited, a half-hour before the start of the meetings as people were coming in . . . When the 30-minute video presentation was over, each group moved its chairs into a circle and plunged into a discussion. Having seen people like themselves on the familiar TV screen, discussing their problems with utter frankness, removed much of the reticence and timidity people have in a group of strangers. They simply said, "I guess this is the place where I can talk freely," and talked at length of problems shared and possible collective solutions.

CHALLENGE FOR CHANGE

An organizing tool

“Could we have stopped people in the street and questioned them, the same way, if we had not had the camera a microphone? I don’t think so. It’s a good pretext for talking to them.”

“When people were interviewed, they became interested in the Committee. Then they came to the public meetings and became involved and eventually joined the team.”

“During the public meetings, with the video program, I had the impression that people really recognized the face of the neighborhood. And they had felt very isolated from one another.”

“People could tell it was another citizen like themselves doing the interview, and they had more confidence in us than they would someone from the CBC or NFB, or other media. Often the press deforms what is said.”

Their experience with video—conceiving, shooting, editing and presenting their own programs—made the citizens particularly aware of the myth of objectivity in mass media reporting and sensitive to conscious and unconscious manipulation. They have become a less gullible public . . . It should be clear that community self-awareness and inter-communications are powerful leveling agents and can set off an unpredictable chain of reaction. There must be a real sense of continuity, and commitment for continuity, if film and video are to be used for real social gain, rather than social disaster. Communities cannot be used as guinea pigs for technology. Technology must serve the communities.

“The people we interviewed on the street—I really felt they wanted to get a message across. They wanted other people to hear about their problems, to share them. People feel pretty isolated.”

“I think people hoped their message would reach the powers-that-be. They had never had the chance before.”

“When we watch the tapes, we don’t just learn to know ourselves better. We also come to understand others better. After that, it’s much more fun to work together.”

In Saint-Jacques, a strongly organized Citizens’ Committee guaranteed responsibility and continuity. These same video techniques could be used in the early stages of organizing by a community organizer who is committed to stay in the community a certain length of time. Social continuity is essential.

Video should not be used in a vacuum, and it should not be used to divert citizens from their social aims.

Video equipment does not create dynamism where none is latent; it does not create action or ideas; these depend on the people who use it. Used responsibly and creatively, it can accelerate perception and understanding, and therefore accelerate action.

The Comité des Citoyens de Saint-Jacques could have accomplished any of their actions without the video equipment. We could not say that at any time it made the difference between success and failure. But it made good things better and helped people to grow. It is a useful tool.



Photo: Dorothy Todd Hénaut

VIDEO OUTREACH

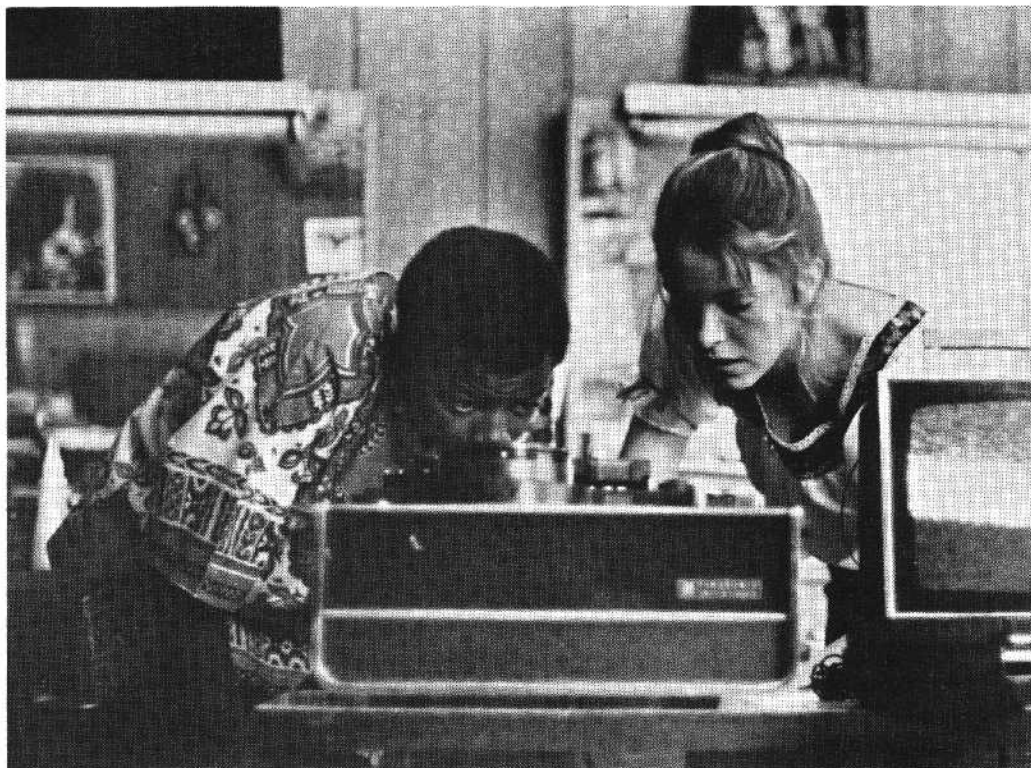

photos: Yolande Valiquette



In the summer of 1971 a group of six, sometimes eight, sometimes three people with assorted interests got together with the Dept. of Urban Outreach at the Philadelphia Museum of Art. The idea was to apply the popular notion of the media bus on a city-wide basis for two months. Communities in the city were notified of the project, and those who responded were visited for a week or so, as the bus people and the community people taught each other some things about community video.

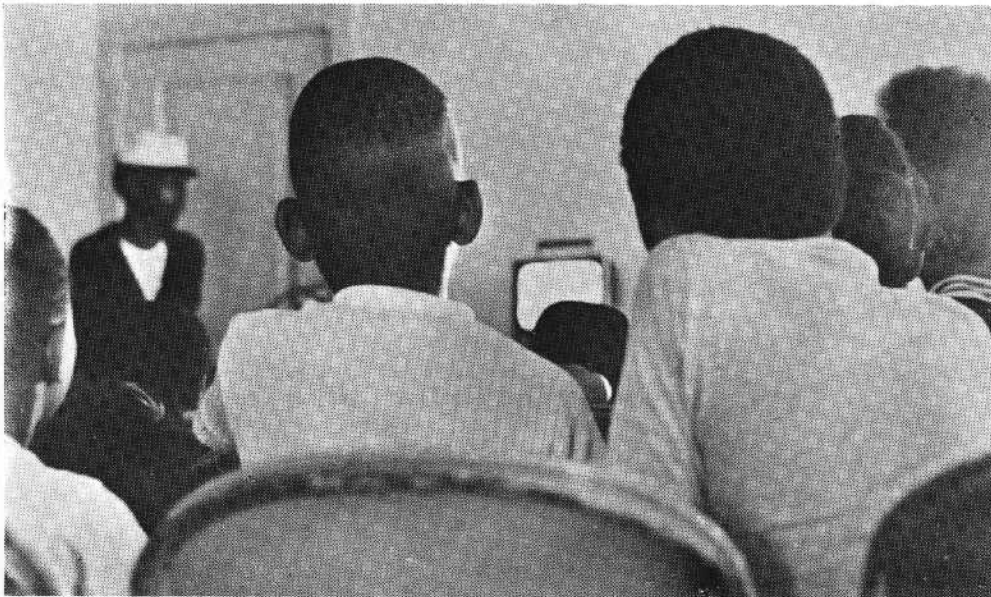

Lots of tape shot, some even edited down and fed back. Although the project sometimes over-reached itself, it did point out some of the problems encountered due to oversimplifying the media problems of the community and those solutions that should be applied.

A week in a community is short. Expect to do not much more than introduce video, and to challenge the myth that only specialized network teams can do local VT. Although this is vital in itself, more sustaining programs, in terms of personal commitment and resources, will have to follow quickly.

Yolande Valiquette
Peter Cuozzo





Alternate networks

I. We're working on communication/information tools. We began with the idea of an ecological information center, and as our work progressed, we became aware of a variety of related efforts. Gradually our focus expanded to cover a range of needs and possibilities summarized here. In addition to thinking through the basic issues, we've been getting together the equipment, expertise, and the basic ideas necessary to do something about them. There's a lot to be done, and perhaps this note can help bring us together to do it.

II. There is a loose network, through publications like this and especially through person-to-person contacts, that serves the communication/information needs of the movement. But people get overloaded and stretched thin, and the information capacity of the network isn't high enough for the things we are trying to do. Groups sometimes operate almost in isolation, cut off from other people trying to do the same thing; and most of us have only limited access to the fund of knowledge and skills potentially available.

III. The tools provided by the existing information/communications technology serve different needs and embody different values. Bulk information systems, such as libraries or computerized information retrieval systems of the standard sort, can't do the job because they are impersonal, rigid, and gruesomely expensive. They have none of the flexible, intelligent adaptiveness of the face-to-face network. The academic system and the business—industrial system have face-to-face networks of their own, but they can't or won't relate to us for obvious reasons.

IV. So, a successful communication/information system is going to require a kind of wierd ingenuity

to get us out of tight places. It may not be clear that this is such a crucial problem. We can't prove it is—our understanding isn't that complete. But we see one of the big problems of the Transformation as the replacement of the hierarchal-coercive institutions by decentralized-consentive ones. A good handle on the creation of communication/information systems wouldn't solve that problem, but it would make it a lot easier, especially for large groups (over twenty) with many conflicting interests.

V. Any useful system is going to have to embody some key values, no matter how it comes into existence, or how it works. Essentially, it will have to be under the control of the people who use it, and not the other way around. It will have to really serve their needs, and it cannot burden or restrict them according to *its* internal necessity. Partly that means we have to be careful of ego and power trips, even very subtle and very justifiable ones. Less obviously, if it is not going to burden and alienate the people who use it and who make it go, it is going to have to be *highly* efficient, returning a great deal of value for very little work.

VI. It may seem that there is a contradiction between an efficient system and one that supports human values. Obviously, we don't think so, or we wouldn't be working on it. We believe the problem comes from the way our society treats design and technology. All the work is done in a back room somewhere, and the marvelous new system is sprung on the hapless population, sealed up in a plastic box to keep out prying fingers. If it doesn't mesh with what people were doing, then it's the people who have to change. That kind of efficiency is over with. The communications/information network of the movement is already here, and it is going to keep in growing and adapting. What we hope to do is design some tools that the network can use.

VII. Those tools can conveniently be divided into hardware and software. The software is fundamental, because it is the cheapest, most flexible, easiest to use and most open-ended. Software for us is the 'how to', tested out until we know it works, and available in a language that people can understand. So far, the network operates almost completely on software, and most of the software is created and tested on a preconscious level. As we bring this creation and testing up to consciousness in our own activities we find all kinds of glitches that can be straightened out and ways that we can use our knowledge about man and the world to strengthen and extend our software.

VIII. The hardware becomes important when we have good software. The computer is a good example. When we have the software down pat, we can program the machine to do the shitwork, and people can play. But if the software really doesn't do the things we wanted, then the system is going to impose its values on us. The computer can't solve our information/communication problems, but it can be a powerful tool in supporting our solutions.

IX. For a long time, human societies have had values similar to ours, without great success in their realization. If we blame that failure on human nature or original sin, then we're stuck. The human race is a biological entity, and biological evolution takes time that we don't have. We prefer to think that failure has come because the tools weren't ready. (or weren't used with enough conscious awareness, ed.). The Transformation is being brought about by the rapid evolution of man's tools, both hardware and (especially) software. If we can push that evolution in the direction of information/communication systems, it may make the big difference.

X. "... take a clay lump to make the dish, and the clay's usefulness is just where it isn't. . . . So you take what of it there is to use what of it there isn't." That's from Lao Tzu, one of the oldest software designers. The value of this note is just where it isn't, in the space it encloses, not in the space it fills. Our ways of working inside this space are growing so fast, and are so open to change that any attempt to describe them is self-defeating. If you find yourself in the same space, and want to share ways of working or problems to work on with us, that's why we're here.

Jes Harris/allen Dragge, 337 Walsh Rd., Atherton, Calif. 94025
415/854-2375



First Progress report letter on rough plans for a Nation-wide "Movement"* Distribution Set-up

(*Open to suggestions for a better word than "movement" or "radical" to describe the broader and more comprehensive conception of social change that has occurred since feminists, gays, high school kids, hippies, ecology people, anarchists, etc. have joined/changed/expanded the

politically narrower "movement" of a year or two ago).

It all started a couple of months ago with the following article in *Vocations for Social Change*:

"There are several small, new radical presses which are producing valuable stuff but which have trouble getting it out, simply because there is no movement distribution network yet. My idea of what is needed is, (1) individuals around the country, on campuses, in the smaller cities as well as large ones, to introduce the liberal/hip/left/campus/head bookstores to movement publications—any and everything from Liberation/Ramparts type periodicals to underground papers, to pamphlet and poster publishers like Times Change Press, People's Press, R.E.P., etc. The individuals would probably have sets of samples, would take orders (and forward them to the publishing group), and hopefully make commissions sufficient to make the efforts worthwhile. Besides these individuals (or collectives) though, it would be necessary to have (2) a nation-wide structure in which to work—a co-ordinating office or something, to get new people distributing, to guarantee commissions and fair play, to send kits of samples around, to publish lists of what stores buy (and pay!), etc.

Financing might come from something like this: Bookstores get 40% off the list price, as it now goes. The local distributor would get maybe 12%. And 3% would go to support the co-ordinating office—leaving the publisher with 45%. A lot of us are feeling the need for outreach—getting beyond the cities and movement. It's badly needed at this time. If anything does come of it, let us hear about it, o.k.?"

Times Change Press, Tom Wodetzki, 1023 Sixth Ave., N.Y.C. 10018





The following is an excerpt from a letter by Ann Arlen to the Superintendent of the Bedford Hills Correctional Facility for Women in upstate New York:

... I would like to use the advantages of the kind of half inch video equipment I use as a video artist to set up a dual purposed communications program at Bedford Hills, combining making a documentary with conducting a series of teaching workshops in video over a period of approximately three months.

The purpose of the workshop would be to teach interested inmates (and perhaps staff) how to use the equipment and then to assist them in making their own videotape productions. Owing to the nature of video, it is my belief that the benefit to the inmates would extend far beyond simply learning another skill, as I will explain below.

The aim of the documentary is to produce a realistic portrayal of the institution by means of communicating who some of the people are, both inmates and officers, whose lives are bound up with it. Naturally, it would be possible to bring a deeper understanding to the making of such a documentary by doing it in conjunction with an ongoing program such as the series of workshops. I also feel that to carry on a professional activity using video during the time period in which the workshops are being held would lend focus and a sense of purpose to the workshops. In addition, there is the possibility that portions of the tapes produced by the workshop participants could be used in the documentary, creating an unusual and multi-faceted document. As you know, I was very much impressed with the feeling that the genuine involvement of the officers with the well-being of the inmates. I feel that a documentary of the sort I would like to do would help to create a more realistic public awareness of what correctional facilities are really about. I am also very much interested in your idea of using it as part of your training program for new officers.

video in prison

The project is possible because of the special advantages of half-inch videotaping equipment . . . Immediate playback is an important advantage in teaching because it is possible to demonstrate the effects of camera techniques, inaccurate tape winding, etc. without waiting a week for developing to produce results. There is a more important advantage of immediate playback, however, one which I feel could be an important psychological by-product for participants in the workshop. Seeing oneself outside of one's own skin, either simultaneously or on immediate playback, as one can with video, must inevitably result in a growth in self-knowledge. I feel that this might be particularly beneficial to inmates who have trouble understanding themselves and their relationships to others.

An important advantage of low production cost is that there is greater freedom to experiment, which means that people learn quicker and can be more creative with video. One benefit of portability is that the equipment is not intimidating and can be taken into situations in which larger equipment would be obtrusive.

Once the workshop participants are trained to use the equipment, you might wish to use their skills to videotape sensitive discussion situations within the institution without creating the anxiety that an outsider might create.

Apart from these advantages of half-inch, there is the fact that it is seen over the same television set that brings us commercial television, and the resulting juxtaposition of the two can be quite illuminating. To continuously be exposed to material which has nothing to do with our lives, via mass media, is alienating and confusing, because its familiarity makes it SEEM real. Seeing a tape which IS about our own reality over the same television set can point up how unreal the other is. For people who have not been able to find a viable place within the society, this kind of purchase on reality could make them feel more connected with the world. There is also something about seeing yourself on television—it creates some perspective about your own importance.

(In addition to the workshops) I would also like very much to set up a "video theater" one evening per week to show the tapes we have made, plus additional tapes of interest, to anyone who wants to watch. In this way I hope to reach more people with the program and also to give the participants in the workshop the important experience of communicating to others in the institution with the tapes they have made.



ANT FARM VIDEO

ALL ABOUT INFLATABLES: How to build an inflatable, physically and metaphysically. 60 min.

WILD SEED: Droll classic of media nomads truckin' through the videosphere. 30 min.

MICE MURDERS: Includes candid video view of San Francisco Major Alioto as he picks lint off his suit, along with media coverage of the Ant Farm as they covered the candidates. A virtual tex - tape in the techniques of broadcast teevee news. 30 min.

PRICES: \$55 an hour, \$28 a half-hour, tape included. \$30 an hour and \$15 a half-hour if you send blank tape.

CONTACT: ANT FARM VIDEO, 994 Union Street, San Francisco, California 94133. (415) 77 - 2368.



ANTIOCH BALTIMORE

CAPT'N FOURTRAC ON HOW TO PROFIT FROM THE PRESENCE OF THE TELEPHONE COMPANY: Useful information on how to cut down your phone costs; Once again Capt'n Fourtrac tells it like it is. 15 min.

MAYDAY: A narrative of the May '71 demonstrations in Washington D.C. Produced with the MayDay Tribe. 30 min.

MAYDAY II: A longer version of the May demonstrations in Washington D.C. put into collage style, and produced by the alternate video groups that came together for the demonstrations. 55 min.

METHADONE—A CONFRONTATION: A report on the fears of the Black community over the social control aspects of a methadone maintenance program. Taped Aug. '71. 30 min.

INSIDE THE MARYLAND STATE PENITENTIARY: Inmates and correctional officers rap on penitentiary conditions. Taped Aug. '71. 25 min.

FACES OF SOUTHEAST BALTIMORE: Street interviews with ethnic Americans of various ages and life styles about their community. 10 min.

THE DRUG BUST: Young people involved in the bust of a large party in southeast Baltimore, and their parents, discuss causes and consequences of police repression in their community. 20 min.

INFLATABLE CONSCIOUSNESS: A historical report on the development of the first air-supported structure to be used as an educational facility. 20 min.

WOMEN ON WOMEN: Women define their views at a march for the repeal of antiabortion laws. 15 min.

UP HIS DOSE: Patients and staff of a government sponsored methadone maintenance program discuss their frustration with the existing drug treatment modality, and attempt to create a therapeutic community. 60 min.

LOCKED IN GREEN ACRES: An in-depth study of a girls juvenile reform school. Interviews with residence, staff, and administrators. 30 min.

FOLLOWING THE VIDEOBALL: Free exploration of the possibilities inherent in the medium of half-inch video tape. 30 min. & 60 min.

PRICES: \$1 per minute, if you provide tape. Will also work on a straight exchange. Send a tape and get one back.

CONTACT: ANTIOCH VIDEO, 805 North Charles Street, Baltimore, Maryland 21202. (301) 752-3656.



ANTIOCH YELLOW SPRINGS

SWANK: Interviews with residents of Swank Apartments in Fairborn, Ohio concerning attitudes toward television, as entertainment, as information, as environment, as purveyor—intercut with broadcast material and overviews by McLuhan. 34 min.

INDIAN MOUND: The excavation during the summer of 1971 of an Indian mound in Glen Helen, including the discovery of skeletons and artifacts. 20 min.

MOOSONEE: A documentary done in Moosonee Ontario and on Moose Factory Island, on James Bay, involving a Cree Indian reservation, the Hudson Bay Company, the development of northern Ontario. 30 min.

GLOBAL MIDNIGHT: A mix of live television, tape television, studio television, music, radio, globe, clock, and the consciousness of the rites of passage. Basic exploration of possibilities for multiple image re-generation effects. 5 hours of tape (a half hour edit of it) and 5 hours of tape on the doing of it.

RIVER FLOW: A piece based on Dylan's song 'Watchin the River Flow'. 3¼ min.

RECALL: Personal Document of experience and its reproducibility, the nature of intermedia, the metaphor of extension and the emergent form of video technology. 17 min.

GUADALUPITA COMMUNE: The lay of the land, face of the people, closeness to life style, camera living in the environment. Exploration of the brick making process. 20 min.

NORTH BEACH SIMULCAST: 2 portables wandering through the same iconographitti in S.F. 20 min.

TUNNEL VISION: Suspense video at its very ultimate—the process of unfolding, the camera as witness to reality's plot. Golden Gate park in S.F. 10 min.

WINTER WHEAT: Dichotomy, a woman walks the desolation between the two darkensses of "I should" and "I am". 17 min.

MOM'S APPLIE PIE: How to do it, going through the process with stoned Cindy and her Dr. Pepper rolling pin. 20 min.

NOTE: An extensive library of off-air (broadcast) tapes are available. Just call or write for tape list.

PRICES: Tapes not for sale. Exchange only. Send your blank tape for dubbing.

CONTACT: Bob Devine or Steve Christiansen, ANTIOCH TELEVISION, Department of Instructional Systems, Antioch College, Yellow Springs, Ohio 45387. (513) 767-7331.



COMMUNITY VIDEO

JOIN THE WAR ON RATS: Community staffers talks about fighting rodents in urban areas. Aimed at the local resident. 15 min.

MENTAL DEVELOPMENT AND MALNUTRITION IN CENTRAL AMERICA: Social anthropologists deal with problems in Guatemala. 25 min.

ALTERNATIVE V.D. TREATMENT: Made with the staff of the Washington Free Clinic. Deals with social reality of widespread infectious disease, and alternatives to medical establishment in treatment. 25 min.

MAYDAY CIVIL DISOBEDIENCE: A narrative and context of the events around the Mayday demonstrations, edited and narrated by the Mayday Tribe (July 1971). 25 min.

CARMICHAEL: Stokely Carmichael on Black liberation. 30 min.

AN ELECTION-YEAR STRATEGY: Tape made by members of People's Coalition for Peace and Justice for use during pre-election organizing. Includes testimony from People's Panel in Washington, Oct. 22-24, 1971, and footage of mass civil disobedience on Oct. 26. 30 min.

BOBBY SEALE: An interview with the Chairman of the Black Panther Party discussing community organizing, politics in the U.S., and the development of a United Youth Party. 30 min.

KATHLEEN CLEAVER: An interview shot on November 19, 1971 just after her return to the United States. She discusses the needs for the Revolutionary Peoples Communications Network as an alternative to the regular media. She also discusses the Black Panther Party, Nixon's visit to China and other topics. 28 Minutes

CARL McINTIRE MARCH: As we try to encourage the use of communications to show all side of an issue we taped this videotape on the same weekend as the Peoples Tribunal in Washington D.C. to bring out some of the contradictions in American society concerning the Vietnam war. 30 Minutes

ANTI-NIXON FAMILY ASSISTENCE PLANNING HEARINGS: This tape was shot under the direction of the D.C. Coalition against FAP and was edited by Welfare Mothers. The tape contains the highlights of two days of hearings held in Washington on the proposed Nixon Welfare Plan. It contains expert testimony from Welfare Recipients and Health Workers, Labor Leaders, Nutritionists, etc. Discussed are the plan for having people work at \$1.20 an hour, inadequate diet, poor and detrimental child care centers, and the questions pertaining to the dangers of household work as domestics. 30 Minutes

HARRISBURG 8: The defendants, their council, and the people of Harrisburg Pa. talk about the Harrisburg Conspiracy Trial, how they feel about it, and what it means to them. This tape was co-

produced with Dispatch News Service International and was done for the Harrisburg Defense Committee with the help and co-operation of the defendants. It has been produced for showing on the local cable television systems, and will be used nationally by the Defense Committee for community organizing work and fund raising. 30 Minutes

LA EDUCATION ES GRATIS: This tape was produced by unemployed workers in Venezuela. It is a dramatic story about a man who loses his job in the city just a few days after his family arrives. After being unable to find a job he must send his son off to shine shoes so that the family can survive thus, his son must leave school and we find that the education is not really free. This tape was acted in, shot, and directed by the workers. We hope soon to be able to provide a written translation with the tape. This tape is an ideal demonstration of the use of Video as a vehicle for communications of the poor. The tape is being distributed by the Community Video Center and the price of this production is \$35.00 which will go directly to the Video Project in Venezuela so that they may continue their work.

THE COMMUNITY AND THE SOCIAL USE OF TELEVISION: This is an edited tape from the twelve community seminars we gave this winter on Cable Television. It is a sequel to our CABLE TV tape. It shows the community talking about Cable and also is useful to those who might be organizing around the cable issue.

BLACKS IN JAIL: Inmates at Lorton Prison talk about the causes and effects of their condition. 25 min.

KIDS AND DRUGS: Ten-year olds talking about drug problems. 10 min.

GUIDE: Concerning a suburban drug program, Washington, D.C. 30 min.

RAP: A communal life style dealing with drug education in the society which creates addicts. Made by members of RAP Inc., Washington. 20 min.

BREAD AND PUPPETS: Street theater during April 24, 1971. Mass anti-war march. 10 min.

BLUES AND JAZZ: Tapes made at 5th annual Washington Blues Festival. Edit includes Voices of East Harlem, B.B. King, Leon Thomas, and the Edwin Hawkins Singers. Unedited tapes totalling 7 hours available from this event taped at Wolf Trap Farm in northern Virginia. 30 min.

MESSAGE FROM A JAIL IN CENTRAL AMERICA: Inmates make a plea to Americans from within their jail. 10 min.

CABLE TV?: An introduction to the technology, history, potential, and dangers of cable television. Made for organizing use in Black communities. 30 min.

PRICES: Costs for non-commercial use are \$18.50 up to 15 minutes and \$30.00 up to one half-hour, tape included.

CONTACT: COMMUNITY VIDEO CENTER, Federal City College, 1424 K Street N.W., Washington, D.C. 20005. (202) 727-2312.

VIDEOTAPES FOR SALE AND/OR EXCHANGE



DMITRI DEV YATKIN

CONCEPTUAL PIECES

BACH KEYED. 15 min.
PERMUTATIONS. 5 min.
FACTORIAL. 5 min.

ELECTRONIC IMAGES TO MUSIC

VIDEO TUNNEL. 10 min.
MOZART FUNERAL. 15 min.
JIM JENSEN KEYED. 15 min.

PRICES: \$40 for whole tape black and white.
\$50 for whole tape colorized. Willing to com-
pose as desired at \$2 a minute.

CONTACT: Dimitri Deyatkin, THE
KITCHEN, 240 Mercer Street, New York,
New York 10012. (212) 475-9865.



FRANK CAVESTANI

LES JEUNES NEW YORKESSES: Illustration of the women of New
York. 60 min.

SUN DANCE AT CROWDOG'S PARADISE: Actual Sioux Indian
sun dance with narration. 60 min.

VAIN VICTORY: The Vicissitudes of the Damned: A play by Jack-
ie Curtis. Performed at La Mama in May of 1971. Starring Jackie
Curtis, Eric Emerson, Candy Darling, Ondine, with visits by John
Lennon, Yoko Ono, and Andy Warhol. 60 min.

PRICES: Les Jeune New Yorkeses, \$50. Sun-
dance, \$50. Vain Victory, \$100. Does not in-
clude shipping and handling. Not for use in
public showings without expressed consent of
Frank Cavestani.

CONTACT: FRANK CAVESTANI INC., 222 West
23d Street, New York, New York 10011. (212)
243-3700.



GLOBAL VILLAGE

VIDEO TAPES BY RUDI STERN

Production Group:
Joie Davidow, Pat Depew, Bruce Ferguson, Ron Kessler,
Susan Shapiro, Sal Spiezza, Rudi Stern, Wayne Hyde

GLOBAL VILLAGE VIDEO JOURNAL: I A video magazine contain-
ing the following elements: Chinese New Year Celebration,
video light composition with laser projections by Lloyd Cross, a
video dance composition at Kasuba's environment with an elec-
tronic work by Emmanuel Ghent, Witch-In at Central Park, Cen-
tral Park Video Poem, Brighton Beach Jewish mothers meet Earth
People's Park: a video confrontation and dialogue, Paul Silbey's
Massage Lesson #1, Open Theater exercises. (B/w & Color, 26
mins., Sony AV5000A)

GLOBAL VILLAGE VIDEO JOURNAL: II Contents: Interview with
Anthony Colombo of the Italian-American Civil Rights League,
Bowery rap, Gay Liberation Day march and interviews, Daytop
Village, Abbie Hoffman at the Judson Flag Show (shot by Jim
Sheldon), STAR: Street Transvestities Action Revolutionaries,
"City People, City Walls" (excerpt from a video documentary
about city wall murals and the reactions of people to these neigh-
borhood works of art), Krishna group in Central Park. (B/w &
Color, 24 mins., Sony AV5000A)

CHRISTOPHER STREET LIBERATION DAY MARCH: June 27,
1971: The second annual Gay March. (B/w, 22 mins., Sony
AV5000A)

CITY PEOPLE/CITY WALLS Giant multicolored murals are a new
ture in many neighborhoods in the New York City. How does the
color and beauty change the lives and outlook of the residents?
(B/w, 18 mins., Sony AV5000A)

COSTUME STATEMENTS: An Exhibition at the Museum of Con-
temporary Crafts, June, 1971. An unusual participation event in-
volving costumes made of unlikely materials and textures. (B/w,
13 mins., Sony AV5000A)

**ST. PETER'S FIESTA: A VIDEO DOCUMENTARY BY JOIE DAVI-
DOW:** A documentary about a four-day Italian Fiesta in Glouces-
ter, Mass. (B/w, 12 mins., Sony AV5000A)

SOHO JOURNAL I: Video tape by Global Village Video Work-
shop groups, edited by Joie Davidow. These Journals profile the
emerging Soho community. How do artists fit into a community
of businessmen, teamsters and factory laborers. (B/w, 15 mins.,
Sony AV5000A)

SOHO JOURNAL II: Interviews with artists, and businessmen,
opinions of gallery owners about the neighborhood, etc. (B/w, 20
mins., Sony AV5000A)

SOHO JOURNAL III: Contains such diverse elements as Em-
manuel Ghent (the electronic music composer), the G.A.A.
Street Fair and interviews in a local barbership, a spirited commu-
nity meeting. (B/w, 20 mins., Sony AV5000A)

CHINESE LOUNGE: A video documentary about an unusual drug
rehabilitation program involving Chinese men (the youngest is
60 and the oldest 86), who were users of opium and heroin but
are now making progress on the methadone program. This tape
was made with the cooperation of the Lower East Side Service
Center. (B/w, 16 mins., Sony AV5000A)

BANGLADESH INTERVIEWS: December, 1971. Interviews with
the president of Dacca University and the Chief Justice of the
Bangladesh Supreme Court. (B/w, 45 mins., Sony AV5000A)

CENTRAL PARK VIDEO POEM: Sundays in New York, an audio-video counterpoint. (B/w, 9 mins., Sony AV5000A)

CONCERT FOR PEACE: "Love, Peace and Happiness" and "Time" by the Chambers Brothers at this concert presented by People's Coalition for Peace and Justice at St. John's the Divine on Dec. 6, 1971. (B/w, 30 mins., Sony AV5000A)

VIDEO TAPES BY JOHN REILLY

Production Group:

Laura Adasko, Louise Denver, Stanford Golob, Terry Greenberg, Ken Kohl, Susan Milano, Stefan Moore, Joel Moss, Garry Ormiston, John Reilly, Dave Sasser, Tim Young

LUCK OF THE IRISH: A video documentary made with the cooperation of John Lennon and Yoko Ono—the title is taken from the song John and Yoko wrote for the project. A number of weeks were spent taping in Ireland in order to piece together the elements that led to the tragic war in the north. Among the many hardships suffered by the crew was their arrest by the British Army. The tape will be released by Global Village and Apple Films in early 1972. (B/w, 50 min. Sony 1/2" video tape, other forms to be announced)

SEA AND CAROL: THE CHILDREN OF BELFAST. Sean, aged 16, and Carol, aged 17, are in a way symbolic of the rebirth of the spirit of the Irish people without the religious hatred and intolerance that has filled the pages of Ireland's history. (B/w, 20 min. Sony AV5000A)

TRANSSEXUALS: Just what is a sex reassignment operation? Debbie Hartman and Esther tell you about their experiences with the world famous doctor in Casablanca and their adjustment problems to the world as women. (B/w, 22 min., Sony AV5000A) New School Project.

VIOLENCE: CITY UNDER SIEGE Rising crime has forced New York City residences to adopt strong methods of self preservation. This tape explores the uses of guard dogs, guns, vigilante patrols and the martial arts. (B/w, 30 mins. Sony AV5000A) New School Project

MENTAL PATIENTS RESISTANCE: Former mental patients, outraged at the abuses of institutional psychiatry, are fighting back. They demand an end to the power of the "ajilers" to forcefully commit and sedate the "mentally ill." The result is a confrontation between the doctors and the ex-mental patients of an extremely powerful nature. Revolution in the hospitals, Mental Patients Liberation Front is formed. (B/w, 30 mins., Sony AV5000A) New School Project

ATTICA The horror of Attica can't really be measured—the scar is deep. This is a look in retrospect at that horror through the eyes of the inmates of Cell Block D with Bobby Seal, Kunstler, Congressman Eve and the inmates. It is a political tape—a counter view, the other side of what was shown on CBS, ABC etc. (B/w, 30 mins., Sony AV5000A) New School Project

WHAT DO YOU DO WHEN THEY'RE BETWEEN YOUR LEGS AND WORKING ON YOU ALREADY? with Peter Urban. Peter Urban conducts a class in the martial arts for women. He instructs them in the de-balling of the unit male attacker. At one point the women stab their victim with a pair of scissors. A special discount is offered for church groups. (B/w, 18 mins., Sony AV5000A) New School Project

WBAI A video tape depicting the activities of this listener-sponsored radio station. Through a series of rapid montages and sequence scenes is profiled. Shown on Channel 13 Free Time Channel 13 (B/w, 18 mins., Sony AV5000A)

BALLAD OF A.J. WEBBERMAN. Alan Webberman, the researcher of the garbage of the famous, is a kaleidoscope of the counter culture. This documentary focuses on Webberman and his in-counters with rock star Bob Dylan. (B/w, 23 or 15 mins., Sony AV5000A)

GOD A tape with Hakim Jamal, who claims he is God. Taped in London in August of 1971. (B/w, 10 mins., Sony AV5000A)

THE LIVING LOFT with Tosun Bayrak. The subject is a "Happening" that could only occur in New York City's SOHO district. The event was staged, if you want to call this blood letting horror sequence a performance, by Tosun Bayrak, the violence artist, as a parable from the "Sufi." (B/w, 15 mins., Sony AV5000A, New School Project)

PRICES: \$14.50 for up to 15 minutes on half-inch including tape costs. \$23 for up to 30 minutes, tape included. If you provide tape charges are \$10 per half-hour, \$5 per quarter-hour, or fraction thereof.

CONTACT: GLOBAL VILLAGE, 454 Broome Street, New York, New York 10012. (212) 966-1515.



JOHNNY VIDEOTAPE

PUBLIC ACCESS CAMPAIGN IN SANTA CRUZ, CALIFORNIA: Contains excerpts from the Scopes trial of public access CATV. Details the confrontation between the Santa Cruz city council and a people's coalition which wanted public access channels for the Santa Cruz cable system. 30 min.

CLEAN ENVIRONMENT ACT: A tape with Ed Koupal, executive director of the California People's Lobby, dealing with how to stop industrial pollution. The People's Lobby was able to obtain over 500,000 signatures to put a Clean Environmental Act on the June ballot in California. If it passes, it will stop all polluting activity in California for at least 5 years. The tape also explores organization of the 18-year old vote and the efforts of Standard Oil to defeat the resolution. 20 min.

PRICES: \$1 per minute, tape included.

CONTACT: H. ALLAN FREDERIKSEN, 695 30th Avenue, Apartment #E, Santa Cruz, California 95060. (408) 476-5871.



MEDIA ACCESS CENTER

WHOLE EARTH DEMISE PARTY: Edited version of the last hours of the *Whole Earth Catalog*. See crowd decide what to do with \$20,000 cash. Plus 12 minutes of Stewart Brand watching the tape you've just seen. 30 min.

JUVENILE JUSTICE: Pioneering tape made by high school students exploring the inanity of the juvenile justice code in California. 60 min.

LIVING SPACES COMPOSITES I & II: The first two in a series exploring the architecture of alternate life styles in California. 30 min. each.

GURNEY NORMAN: Process video of the author, whose novel, *Divine Rights Trip*, appeared in *The Last Whole Earth Catalog*. Unedited so far. Request details.

PRICES: \$55 an hour, \$28 a half-hour, tape included. \$30 an hour and \$15 a half-hour if you send blank tape.

CONTACT: MEDIA ACCESS CENTER, 1115 Merrill Street, Menlo Park, California 94025. (415) 323-5155.



ERIC SIEGEL

COLOR COMPOSITE: Einstein (5 min.)-video exploration into the inner essence of the mind of Einstein. To the music of Rimsky-Korsakoff. *Symphony of the Planets* (12 min.)-Cosmic flight to the music of Tchaikovsky. *Tomorrow Never Knows* (2¼ min.)-video abstraction to the music of the Beatles.

PSYCHEDELIVISION: An expression of the Karma of 1968 through abstractions combined with outside reality. 30 min.

NEW YORK, NEW YORK: An exploration of that well-known metropolis. 1971. 30 min.

STOCKHOLM VISITED: New style video showing life in Sweden. 1971. 30 min.

ISRAEL: New style video showing life in Israel. 1971. 30 min.

VIDEO SYNTHESIS: A tape composed on the Siegel Video Synthesizer which synthetically creates video images without camera input. In color, of course. 30 min.

PRICES: Videotapes available in both black and white and color (for Sony AV5000a). \$50 for each 30 minute tape.

CONTACT: ERIC SIEGEL, c/o Howard Wise, 2 West 13th Street, Room 1011, New York, New York 10003. (212) 253-0082.



NCV VIDEO

The following is a partial list of NCV videotapes available for distribution. Our work primarily involves rock tapes and experimental abstraction including the use of lasers, complex feedback, and audio-video-bio interface.

NCV SAMPLER 40 min. (colorized)

ALEPH-NULL 13 min. (col. or bw) by Shridhar Bapat and Charles Phillips. Shown at Whitney Museum Videotape Show.

BAD COAX BLUES 8 min. (col. or bw) by S. Bapat and C. Phillips

MOUNTAIN FEEDBACK 7 min. (col. or bw) by S. Bapat and Dan Coffey

EMBRYO 10 min. (colorized) by S. Bapat and Dan Coffey

LASER BALLET 20 min. (colorized) by Robert Lewis and C. Phillips

ALBATROSS FEEDBACK 10 min. (col. or bw) by Robert Lewis

T. & E. 20 min. (colorized) video mix by Robert Lewis

PRICES: All tapes and copies are on standard Sony ½" AV series. Black and white versions will be available at \$1.80 per minute. Colorized tapes at \$2.30 per minute. Minimum length of order is 5 minutes. On request, tapes will be available in other formats (e.g. one-inch video or film).

CONTACT:
SHRIDHAR BAPAT
308 West 103rd St. (5-E)
New York, N.Y. 10025
(212)-222-7992

DAN COFFEY
c/o Shridhar Bapat

ROBERT LEWIS
Center for Advanced Visual Studies
M.I.T.
40 Massachusetts Avenue
Cambridge, Mass. 02139
(617)-864-6900 x6849

CHARLES PHILLIPS
36 Irving St.
Cambridge, Mass. 02138
(617)-876-8878



PEOPLE'S VIDEO THEATER

Notes on Present Tape Catalog:

This is a listing of edited tapes. However, there are many other hours of unedited tapes related to these. Almost all are 1/2 inch videotapes suitable for cable casting.

LIBERATION 1970: Edited selection from liberation tapes made in New York City. Includes Squatters Movement, Women's Lib march on Fifth Avenue, Gay Lib demonstration in Central Park, Young Lords in Spanish Harlem, and American Indians at Plymouth Rock. 30 min.

AMERICAN FLAG: People's feelings about the American flag at the time of the Kent State incident and hard hat demonstrations. 20 min.

PLANT STORE: Manager of exotic plant store shows how to give your plants the loving care they need. 15 min.

MAGIC FLUTES: Hal the bamboo flute peddler shows how to make bamboo flutes and how to push them on the streets of New York City. 15 min.

INDIAN THANKSGIVING: Indian demonstration at Plymouth Rock on Thanksgiving Day. Symbolic burial and the taking of the Mayflower are highlights of Part I. Part II is an Indian Thanksgiving dinner with representatives from the Indian movement speaking about what the future of the Indian in America will be. 2 tapes, 30 min. each.

PHYSICAL EXAMINATION: Doctor explains in layman's terms how certain parts of the body work. Tape emphasizes a need for communication between doctor and patient as part of a physical examination. 30 min.

V.D.: A young doctor and nurse go out into the street to educate people about V.D. There they encounter the problems of communication created by the medical establishment. 15 min.

WHO WE ARE: A demonstration on how to use a 1/2 inch video system in the street to turn people on to making community programming. Also discusses some potentials of cable T.V.

CAMP JENED FOR THE HANDICAPPED: An intimate view of camp life. Handicapped people use the media to speak for themselves. 30 min.

CRAB EPIDEMIC: How Camp Jened for the Handicapped deals with the crisis of a crab epidemic. 30 min.

NEW YORKER'S MESSAGE TO SAN FRANCISCO: Video street theater where drummers drum on concrete while old men, poets, mothers and children, cops and robbers, and cosmic hero vendors use masks and props to send messages about life in New York City to the people of San Francisco. 30 min.

ST. VINCENT'S HEALTH DAY: People's Video Theater works with St. Vincent's Hospital during health day to illustrate how 1/2 inch video can be valuable to a hospital and the community it serves. 30 min.

WASHINGTON SQUARE MEDIATION: Video is used to create a communications channel. Park users, local leadership, and city government are brought together to deal with the problems created by the closing of the park during its renovation. 30 min.

AIR POLLUTION: Scientists from Boice Thompson Institute explain the effects of air pollution on plants. The New York bridge and tunnel workers describe their long battle to get adequate medical testing for the effects of air pollution as well as equipment for pollution control. 40 min.

PALM READING IN WASHINGTON SQUARE PARK: Skeptics and believers get their palms read in Washington Square Park. 15 min.

MERRY CHRISTMAS 1971: A Christmas Eve search for Christ on the streets in the bars of downtown New York City. 20 min.

ATTITUDES TOWARD CRIME IN ORANGE, NEW JERSEY: The people of Orange speak about crime and justice. Edited from 10 hours of tape shot in the streets, schools, homes, and institutions of Orange, N.J. 30 min.

SERIES OF UNEDITED TAPES ON TAI CHI CHUAN: Includes Tai Chi form, push hands, swordplay, and flower arranging. Made with the cooperation of Professor Cheng Man-ch'ing.

PRICES: \$1 per minute, if you provide tape. If not, add \$15 per half-hour and \$30 per hour for raw tape costs.

CONTACT: PEOPLE'S VIDEO THEATER INC.,
544 Sixth Avenue, New York, New York 10011.
(212) 691-3254.



RAINDANCE

VIETNAM: A record of GI life on a fire base north of Saigon. First porta-pak footage from Vietnam. Shows what broadcast teevee doesn't. 12 or 60 min edit.

FLASH PASTEURIZED OR SONG OF REDCHEEK: An assemblage of some of the best life style tape made during the very early days of portable video (January 1969). 10 min.

THE RAYS: Video acid trip on a California beach. Another early one from the Raindance archive. (March 1970). Unedited. 20 min.

DOUBLE FEEDBACK #2: A pioneering tape exploring video. Two people experience an environment of three monitors feeding back into themselves: one real-time, another at a six second delay, the third at a 12 second delay. Includes audio feedback too. Unedited. 30 min.

THE RAINDANCE STORY: An intimate look at the well-known video group, together in their Manhattan loft. Unedited. 30 min.

STONED AGAIN: Special Tivicon low-light camera records odd, illicit behavior among youths. A block-buster. 15 min.

THE BEST OF THE ACME VIDEO RANGERS: Includes Andy Mann's famous subway tape and a second feature—Born to Kill. 30 min.

THE ABORTION: A tape of an abortion edited by the woman who had it. 30 min.

PRETTY MUCH AS JAILS: Concepts in alternate education talked about and demonstrated. 15 min.

CRAFTSMEN: In search of the rural craftsman: a chair caner, a leather tooler, a bookbinder, and a McDonald's hamburger maker. 30 min.

UP IN DOWNSVILLE: Portrait of a small town in upstate New York with appearances by the local police, a realtor, and just plain folk. 30 min.

VIDEOTAPES FOR SALE AND/OR EXCHANGE

ALTERNATE EDUCATION: Distillation of a conference held at the Metropolitan Museum in New York during June of 1971. 20 min.

Also: Videotapes edited to your needs. We have over 250 hours of videotape covering the full spectrum of alternate TV activity. If you need tapes for: setting up a media program at a university, running a video theater, demonstrating what videotape can do, etc., then write us for special videotapes. And, of course, we will exchange our software for yours on an equal basis. Send us your tapes. Get ours in return.

PRICES: \$55 an hour, \$28 a half hour, tape included. \$30 an hour and \$15 a half-hour if you send blank tape.

CONTACT: RAINDANCE, Post Office Box 543, Cooper Station, New York, New York 10003. (212) MU-7-4210.



THE VASULKAS

MASTER 3: RECONNAISSANCE. 10 min.

1. SPACE OBJECTS
2. MATRIX
3. RANDOM NOISE

MASTER 1: FLYING FEEDBACK. 6 min.

1. KEYED FEEDBACK
2. OBSCENE MUSCLE
3. PULSATING SUN
4. BLACK SUNRISE

MASTER 2: GERMAN EXPRESSIONISM. 5 min

1. UNIVERSE
2. KEY HOLES
3. COUNTERPOINT

ENVIRONMENTS: 30 min.

1. SPACE
2. BLACK SUNRISE
3. HORIZONTAL SUNRISE

SKETCHES

1. JACKIE CURTIS
2. RED ROSES
3. LET IT BE
4. CHARLES' STORY
5. ALFONSE
6. THE TORTURE CHAIR
7. DON CHERRY

DECAY: 10 min.

1. DECAYING FACE
2. TISSUES
3. ELECTRONIC LANDSCAPE
4. DALI LANDSCAPES AND OTHER SMALL PIECES.

DESCENTS AND CALLIGRAMS. 8 min.

ENVIRONMENTS 3: 8 min.

1. ZEBRA DISCS
2. SHAPES

SWANLAKE BALLET. 4 min.

VIDEO BALLET. 6 min.

PRICES: \$1.60 a minute black and white. \$2.00 a minute colorized. All tapes individually colorized by certified video artists.

CONTACT: Steina and Woody Vasulka, THE KITCHEN, 240 Mercer Street, New York, New York 10012. (212) 475-9865.



VIDEOFREEX

EDUCATIONAL/INFORMATIONAL

KANSAS CITY READING PROGRAM: Progressive teaching method. 28 min.

TECH TAPES: #1-Dr. Electron explains coax cables and video repair tools. #2-More coax and audio connectors (soldering). #3- Changing the video heads. #4- Changing the vidicon tube. #5- Adapting a Porta-Pak for coax-out. 30 min. each.

HOW TO SILK SCREEN BY HAND: With artist Bill Cox. 60 min.

BUILDING A DOME: In 5 minutes you see it happen. Complete informational tape to follow. 5 min (for now).

FERRO CEMENT: Orientation on materials and process. 30 min.

HOLOGRAPHY: Basic theories. With Lloyd Cross. Unedited. 20 min.

THE JERUSALEM TAPES: Series of short pieces shot in Jerusalem. 30 and 60 min.

Coming: Tapes on traditional crafts like spinning of flax and wool, making a wooden shovel, many others.

EXPERIMENTAL/MISCELLANEOUS

WINTER IN NEW YORK: 6 min.

WALL GAZING: Zen experience. 25 min.

TAI CHI WITH GEORGE: 9 min.

EASTER SUNDAY: Easter in Central Park. 10 min.

ANIMAL MIX: Interviews with animals. Train your dog to be a killer. A deer gets killed in Connecticut. Other short pieces. 30 min.

HIDE: A drama. 18 min.

AND IN THE PROCESS OF TIME IT CAME TO PASS: Modern day version of that timeless classic, the story of Cain and Abel. 30 min.

I SAW MY FACE ON TAPE TODAY: 10 min.

HENRY, MUSHROOM, AND SAM: 4 min.

FEEDBACK: Electronic feedback experiments with music. 30 min.

EVENTS/THEATRE

LOVE AMERICA OR LIVE: Tosun Bayrak's street theater . . . gory. 14 min.

PARSON'S NON-VERBAL: Experiment in non-verbal communications. 20 min.

INDIAN POETRY: Jerry Rothenberg poems in english with American Indian phrasing and rhythms. Unedited. 30 min.

TULI KUPFERBERG'S REVOLTING THEATER: Skits n' shit. 30 min.

NO TRAFFIC: A guerrilla theater group gets busted in Montreal. 22 min.

THE CIRCUS: Shot at Madison Square Garden. Unedited. 30 min.

RICKY'S MAGIC: Long-haired magician and a close-up of his magic show. 7 min.

EROTICA

AFTER THE BAR: Rated R. 15 min.

POLITICAL

FRED HAMPTON, 1969: Rap in Chicago prior to his assassination. 12 min.

HARD HAT RALLY: In New York. 11 min.

MAY DAY IN WASHINGTON, 1971: Demonstrations shot and edited by the May Day Video Collective. 56 min.

WOMAN'S TAPE (MIX): Events, raps, demonstrations, abortion information, etc. 30 min.

PRICES: \$55 for one hour, \$30 for half-hour, tape included. If you send tape it's \$28 and \$15 including postage. You keep all software you buy.

CONTACT: VIDEOFREEEX, Maple Tree Farm, Lanesville, New York 12450. (914) 688-7084.

VIDEOTAPES FOR SALE AND/OR EXCHANGE

THE MINNEAPOLIS COLLEGE OF ART AND DESIGN

FIRST NATIONAL VIDEO TAPE FESTIVAL
AND WORKSHOPS

Open to U.S. residents and organizations

Entry video tapes:

May be submitted under the following categories:
video-art, student and educational videotape recordings

May not have been produced for or shown on commercial television

Entries postmarked no later than May 31, 1972

Nationally recognized jury

Announcement of winners and awards on or before August 31, 1972

National showcase for award winning tapes at The Walker Art Center

Video workshops held in conjunction with judging (August 7 through August 20)

For further information on the competition and workshops, and application forms, contact:

Director
First National Video Tape Competition
Minneapolis College of Art and Design
200 East 25th Street
Minneapolis, Minnesota 55415
(612) 339-8905

Assisted by grants from the Avon Foundation, St. Paul, Minnesota, and the National Endowment for the Arts

Feel Your Groove



EDITOR'S NOTE

Ben Sidran is a friend of ours who has published a book (BLACK TALK, Holt, Rinehart & Winston) and recorded an album (FEEL YOUR GROOVE, on Capitol). We think you'll like them.

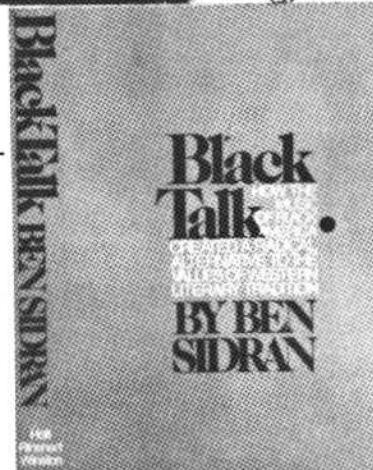



CONTENTS

CHAPTER ONE: VIDEO HARDWARE.....	[PAGE 2]
EDITING.....	[7]
SOURCES OF BEGGING, BORROWING OR BUYING VIDEO EQUIPMENT.....	[9]
CHAPTER TWO: METHODS OF VIDEO SOFTWARE (INFORMATION) DISTRIBUTION.....	[12]
C.A.T.V.	[12]
CLOSED CIRCUIT SYSTEMS.....	[14]
VIDEO-TO-FILM TRANSFER.....	[15]
TAPE EXCHANGE and NETWORK BROADCAST.....	[16]
CHAPTER THREE: FREE YOUR LOCAL CABLE FOR ALTERNATE PROGRAMMING.....	[17]
FRONT 1: THE CABLE OPERATOR.....	[17]
FRONT 2: CITY COUNCIL and FRANCHISE.....	[19]
CHAPTER FOUR: FORMING YOUR OWN NON-PROFIT CORPORATION FOR \$20.....	[25]
CHAPTER FIVE: ECONOMIC SURVIVAL WITH VIDEO.....	[29]
EDUCATION.....	[29]
SPORTS FIELD and SERVICE BUSINESS.....	[30]
VIDEO PORN FOR FUN AND PROFIT.....	[32]
SANTA CRUZ COMMUNITY SERVICE T.V. PROJECT.....	[34]
CHAPTER SIX: COMMUNITY VIDEO IN SANTA CRUZ.....	[36]
CHAPTER SEVEN: VIDEO TECHNIQUE AND FORMATS.....	[42]
CHAPTER EIGHT: THE FUTURE.....	[47]
VIDEO VOCABULARY.....	[48]
APPENDIX "A": PUBLIC ACCESS CHANNELS: THE NEW YORK EXPERIENCE.....	[50]
APPENDIX "B": THE VANCOUVER EXPERIENCE.....	[54]
APPENDIX "C": PEOPLE.....	[55]
APPENDIX "D": TWO NEW BOOKS: "GUERRILLA T.V." and "DON'T BLAME THE PEOPLE".....	[58]
A PAID POLITICAL ADVERTISEMENT.....	[60]

COMMUNITY ACCESS VIDEO

is a handbook prepared by Allan Frederiksen who works under the name of Johnny Videotape. It details his own experience in Santa Cruz, California, trying to get public access written into the city cable franchise, an effort which has included organization of a referendum to force redrafting of the existing franchise agreement.

In addition, Frederiksen takes a beginner through the process of acquiring and using hardware and accessories. Thus, *Community Access Video* is a good Porta-Pak handbook, especially if you're working alone outside of a big city where technical information is hard to come by.

This isn't the ultimate book on do-it-yourself television, but it doesn't pretend to be. The author had to pay the cost of printing 3,000 copies himself and its format is the outsize, low-key, easy-to-read style of other California journals like the *Whole Earth Catalog* and *Big Rock Candy Mountain*.

We're publicizing it here not only because we think you'll find it valuable, but also because it may be hard to come by through bookstores. So, you can mail order copies (at \$3 apiece) from the author by using the form below.

H. ALLAN FREDERICKSEN - 695 30th Avenue - Apt. E - Santa Cruz, California 95060

NAME _____

ADDRESS _____

CITY _____ STATE _____ ZIP _____

Please send me _____ copies of **COMMUNITY ACCESS VIDEO** at \$3.00 per copy. Enclosed is _____.

This piece by Ann Arlen is an excellent, concise overview of the experience we've been having in New York City. As she indicates, guaranteed access is just the first step. Once you've gotten your tapes on a cable system you've got to get viewers to change their habits and incorporate your input into their lives. Remember, the success of the commercial networks isn't that they provide programming every now and then, but that their very existence creates a habit pattern in the majority of peoples' lives.

By way of introduction, and to add some details to Ann's article (originally done for *Foundation News*), some of the frustrations we've encountered are:

1. Inadequate facilities: The Sterling-Manhattan system has only one half-inch playback deck (an AV5000) which is left on an old card table in the corner of the studio. Moreover, they have no switcher so that even if you bring up your own deck there's still an interval between tapes when the engineer patches from one to the other. And it's not uncommon for the engineer to miss the end of a tape because he's on his coffee break or chatting with someone in the other room. The result is intolerable dead time on the screen.

John Sanfratello of Sterling, who has emerged as a genuine hero through his ceaseless energy on behalf of Public Access, says he submitted a \$9,000 budget to his management for a half-inch studio to include Public Access editing and community Porta-Paks. But not until the fall, if then.

Finally, until just recently we were plagued with downright shitty transmission. Edited tapes wouldn't hold up and even second generation tapes wouldn't play right. This was due to the state-of-the-art of Sterling's equipment. If you are negotiating a franchise, make half-inch compatibility a prerequisite. Even with old equipment, it can be done, as Sterling demonstrated, by sheer persistence in trouble-shooting the problem. Sanfratello had to hassle with his own company's bureaucracy to get into the headend room to solve the problem (because that was the domain of another department).

But we still can't do live transmission which means there's no way to get real time feedback on what's being shown, or to make contact with the community.

The problem is, as stated elsewhere, that Public Access is a service that the cable station *has* to provide, not one they want to. Because they don't believe that it can enhance the financial position of the system, they are making the minimum commitment in time, money and imagination.

2. No money: Ultimately it is a rip-off for a profit-making business to get free products to sell. There must be money coming back from a cable station to Public Access programmers. Five percent of the system's revenues in New York already go back to the municipal government. Thus, the next step is to get the city government to turn around and distribute that revenue to producing groups. Or, cable systems should be required to directly underwrite community access programs. Better, however, to consider public access a selling point and incorporate it into the profit structure of CATV through subscriptions.

Publicity: Because the New York cable owners think of Public Access as a chore, they have no incentive to publicize it. But you can't establish a habit pattern without information about what's available. Thus, Public Access must require a publicity commitment on the part of the system owner in the form of a programming schedule sent to subscribers and listings in local newspapers.

(So far, the Sterling system has sent nothing to its subscribers publicizing Public Access, even though they mail their own hype at least once a month. A project to get them to subsidize and mail a brief brochure for Public Access has been met by continual requalifications. Management there apparently feels that Public Access is just another drain on a company that already is showing a loss, not that it is something people would want to pay to see. To their credit, they have begun an electronic listing of Public Access programming using a camera which scans typed descriptions of what's coming. They have also been frustrated by the unreliability of programming groups in getting tapes to the station on time.

Teleprompter, on the other hand, had printed and distributed tens of thousands of brochures promoting Public Access at their own expense. They have maintained much more suitable equipment for half-inch transmission. And they are now aggressively programming local news).



The Second Coming of Television ?

Public Access:

In some parts of New York City today a dial twister with cable television could be looking at some pretty unusual programs. Often unannounced and without titles, these programs pop onto the screen to run for half an hour or an hour, sometimes breaking up into stripes, occasionally vanishing into snow, leaving a viewer with only the sound to help unravel the mystery of what the program is and who is doing it. In a time when we can almost take for granted a first-class television picture, it is not to be expected that anybody would want to watch a channel whose picture quality consistently duplicates that of the earliest days of television. But for some people these programs on the new Public Access cable channels in Manhattan are charged with an excitement unequalled by anything television has ever done, their very presence a crazy miracle, a chance to change the course of the nation's most promising and least fulfilled mass communications medium.

Strictly speaking, the Public Access channels could be defined as those set aside for direct use by the public, with no control over program content being exercised by an intermediary, such as the cable operator, other than that necessarily imposed by libel and profanity laws. Cable time is made available to groups or individuals, free of charge, on a first-come-first-serve basis, providing us with what may well be our first experience of an electronic mass medium through which people may talk to other people unmanipulated by media professionals.

Instead of learning about a rent strike in full swing on New York's West Side as a 60-second slice of picketing accompanied by a smooth commentary by an announcer (whose diction can't be faulted, but who tells you how many people were killed in a local fire in the same tone he tells you the football score), you find yourself looking at a tape of a building meeting made in the apartment of somebody who is trying to organize a rent strike. Such a presentation on the Public Access channel of a budding rent strike cost fifteen dollars for thirty minutes of (re-usable) half-inch videotape. The tape communicated something about the lives of the people in the room, and one could get a pretty good sense of why they were desperate to make changes. The tape was made, NOT at the point in the strike which would be most attention-getting, most newsworthy—namely, the point of heated confrontation, of people out of their minds with rage and despair. It was presented pre-event, when people were trying to get something done, because that's when the people who cared most about it thought it should be presented. Since they could afford the \$15. it cost to produce it, they could decide when it should be produced.

This brings up an important difference between Public Access and commercial television. When rent strikes are presented by commercial television they ARE presented as "news", not information. When one sets the two side-by-side, one realizes that the meaning of real events and real experiences must be altered to be saleable to ourselves, the viewing public as "news". As a result of this placing of the events of our lives on the market, our own perceptions as a people have been altered and our need to know has been exploited, however unintentionally. We are wooed by competing news shows, but neither we nor, probably, the people who produce the shows, realize that the "news" we are sending out and receiving has little meaning for us because it has little to do with the events reported or with our own experience. Public Access can give us experience of what the communication of the events of our lives can be when it operates free of the necessities of the news-marketing format.

Another aspect of news-marketing was succinctly phrased by Edward R. Murrow when he said, "Good news is no news." Some of the tapes shown on Manhattan's Public Access channels have documented people's pleasures and the beauty they find: a group of people getting together to make music, just for the fun of it; an Armenian grocer who clearly enjoys the Greek and Armenian specialties he sells; a half-hour tape of a running brook, because it is beautiful. Commercial television does much to reinforce our awareness of threats to our well-being, of reasons to despair; it very rarely validates or intensifies our awareness of the joy in being living creatures. Public Access will undoubtedly show us a different side to life, providing an opportunity for many people to have input into the collective bank of information that we form with mass media, rather than leaving it up to a few networks to form our collective awareness.

The Public Access cable channels came into existence as a result of several communications "events": the growth of cable television; the separate but parallel growth of a semi-communications, semi-artistic, field around the inexpensive and portable form of television taping, half-inch video; the growth of a recognition, among many of those involved with mass communications, that the broadcast television industry has, for the most part, become locked into a system of economics and of thinking which can never permit the realization of its great promise.

Cable television itself did not grow up in answer to a need for more and better programming, rather in answer to the need for a better picture of the same programming in bad reception areas. Entrepreneurs saw money in the system, and they developed CATV, as it is often called (for Community Antenna Television), elaborating it to include services and programming not offered by broadcast television.

People receiving their television over-the-wire instead of over-the-air pay about six dollars a month for the service and expect to receive in return a pretty good picture plus perhaps some local sporting events and local news. What they do NOT expect, yet what is predicted from many communications quarters for the cable, is a communications revolution of such major proportions that it could change all of our lives. The unique construction of the coaxial cable (the cable is not just a sheathed wire—there is an electromagnetic relationship between the wire and its sheath which prevents radiation of current and allows the cable's great capacity) permits it to carry information of unprecedented amounts and variety with considerable flexibility. A broadband cable network (BCN) can allow us to order and receive in print-out form books, magazines and newspapers, information from data banks and computers. It would be possible to order from a store, to be billed, and to have the amount deducted automatically from our bank balance. (For the definitive handbook on CATV, see Ralph Lee Smith's article, "The Wired Nation", which comprises the May 18, 1970 issue of *The Nation*; also *Scientific American's* November 1971 issue has a somewhat sketchy technical run-down.)

From an historical perspective, this is a strange period for communications; given the nature of our country, there seems little question that the cable WILL cause profound changes in our lives, yet those of us who work with it today are dealing with quite a prosaic medium. It is hard to keep remembering that the thing is going to grow beyond recognition. Yet it is important to remember it, because we are not faced with the question of WHETHER cable should be used for change; cable IS change, and we may still have a chance to determine WHAT change—humane or inhumane, life-fulfilling or life-denying. Public Access has an important role to play in these determinations.

Since the Manhattan Public Access channels are the first ones operative in the country, they are quite naturally regarded as a test of whether or not Public Access channels are needed and whether they can work. The difficulty with using them as a test, however, is that the concept of regular people being able to appear on television in an everyday way, and talk to other people who make up a viewing audience, is so alien to us in this land of experts that Public Access is in the difficult position of having to succeed in order to succeed. Public Access must succeed in making itself known to potential viewers and users before it can be successful; and it must have a viewing constituency to amount to real Access. Talking to yourself is hardly access, even if you ARE doing it over a television channel.

Public Access has a long way to go before it can begin to have impact. In actual fact, New York's Borough of Manhattan has the only formally operative Public Access channels in the country. If Public Access is to become a reality, people in towns and cities across the country which are now in the process of issuing franchises to cable operators need to know that the franchise agreements can include a requirement for free Public Access channels. Although the Federal Communications Commission's February 12, 1972 rule-making on cable television (see bibliography) includes a requirement that there be one Public Access channel in each CATV system within the top one hundred television markets, the requirement does less than it might have to promote Public Access television. For one thing, it requires only one Public Access channel, whereas the Manhattan franchise, which up until the rule-making had been regarded as a possible Public Access standard for the FCC, requires two. In addition,

John Sanfratello, Sterling Manhattan CATV: "I think that our people (the cable companies) are going to have to come to the realization that the public channels are an obligation, and that the same care in the broadcast of the public channels should be taken as is taken with our commercial channels... I think that any CATV operation that is put into a situation where they may not have voluntarily said that they're going to have the public take an active part is going to be a little untidy about the type of signal that they're putting out on the public channel... That's only because it is a profit-making organization, and they want to concentrate on making enough money to keep the operation going and to get more cable out, which is where the biggest expense is right now... If I were a foundation, I would give money to people who are producing programming. I would stop giving money to organizations who are supposed to make information on the public channels available; I think that was started because it was felt that the people who would get involved from the CATV companies would try to cut out as much (of the Public Access programming) as possible. I don't think that has happened. I think the CATV companies have upheld their obligation - they're doing a pretty damned good job with the Public Access channels. They could have fought it very, very hard...."



Thea Sklover, Open Channel: "I would like to do more training in high schools on use of video equipment because I feel that young people are a very logical place to begin getting more and more people within the community who know how to make video on their own, who know how to produce television. It's a responsibility I feel we have now, that every young person should have the skills of video, just the way they have the skills of writing. It's one of the main ways that they'll be communicated with in their lives, and if they have no control over it, then it's always being used on them. They have no defense, no understanding of it, and they have no way to communicate with it. Communication should go two ways; right now, in terms of video, most people can only receive it, they can't give it....Right now we need money for equipment and for people, people to man the equipment, people to train, people to maintain the equipment, people to go out and tell other people in the community about Public Access....Public Access in New York has just barely been born; it's at its very earliest stages. It's just beginning to be picked up by the media. People who might make use of it are just beginning to know of its existence...."



and perhaps more important, the requirement *may not be exceeded* without special permission from the FCC. In an area of little population, a single Public access channel might be adequate; but in a heavily populated area, where the demand could be much greater, provision should be made for not only a "soapbox" channel, where people can express themselves on specific issues, but a channel where ongoing programming can begin to build audiences. In areas outside of the top one hundred markets, the FCC has ruled that franchise requirements for Public Access may be made, but that they may not exceed the FCC standards for the top one hundred markets.

Building an audience for Public Access requires commitment on the part of the cable operator. The best way of letting people know about Public Access is by publicizing it over the cable system's own origination channels and in their mailings to subscribers. Newspapers should also carry public channel announcements along with their television listings (they have yet to do so in New York). A particularly heavy commitment is required of the cable operator in order to maintain a picture quality adequate to attract viewers. To begin with, the expenditure of money on equipment and man-hours necessary to maintain a good Public Access signal is probably the same as that required to maintain a good signal on a paying channel. In addition, there are the special technical problems presented by cablecasting half-inch videotape.

Without half-inch video, Public Access would not amount to much, because it is the only videotaping process suitable to the particular needs of Public Access, in that it is cheap, portable, and easy-to-operate. BUT, as its principal manufacturer, SONY Corporation, tells its complaining cable-users, it was never intended to be cablecast or broadcast, and thus far, SONY has declined to modify its equipment for CATV use, the CATV market being a small one. The chief difficulty is the "time-base" problem: the speed at which the tape passes the recording-playback heads on the half-inch machines tends to fluctuate, causing a tape signal which lacks precision. If the fluctuation is not too great, a home receiver can "lock in" on the signal and produce an acceptable picture; but if the problem is magnified by problems in the cable system's own signal, the picture on the home receiver can be totally unintelligible. The long-range solution is to find a manufacturer who will produce an adequate machine. The immediate solution is two-fold: one, to make available to people doing half-inch programming a free or nominal service for checking their equipment on a regular basis; two, a committed effort on the part of the cable companies to bring the signal of the Public Access channels up to the standard maintained by the cable channels transmitting network programs (this should be a franchise requirement), and also to make modifications adapted specifically to half-inch.

In Manhattan there are two franchises, and it is useful to compare their handling of their Public Access channels. Although they were officially opened only last summer and did not really get started until Fall, both companies are receiving considerable public channel programming. Of the two companies, Sterling Manhattan (Time, Inc is the major owner), which has the middle and lower portions of Manhattan, has attracted the most programming. They got off to a slow start by charging a maintenance fee per program for the use of their equipment, but they waived the fee when it became clear that would-be users could not pay it, and they have in general made a solid effort to work with the problems of cablecasting half-inch videotape. The company's programming director, John Sanfratello, would rather not have to work with half-inch. But, recognizing its necessity, with the cooperation of the company's president, William Lamb, he has put his engineering background to work, along with the know-how of his best engineers, and has begun to find solutions. The result has been a noticeable improvement in their Public Access signal, to the point where, on good days and in the right sections of the city (where their equipment is newer and better), it is possible to see a Public Access cablecast of a half-inch tape and not to be able to distinguish it from any other good cablecast.

Teleprompter, on the other hand, got off to a good start by charging no equipment-use fee, and for awhile was much more heavily programmed than was Sterling. But the signal on their public channel is so poor that even technically superior material comes over badly. They promised improvements by the end of 1971, but it still looks bad. The most reasonable explanation, given by one of their technicians, is that they are microwaving their public channel, rather than cablecasting it, and are using outdated equipment. Microwave requires monitoring to make sure the sending and receiving equipment are in proper alignment; if they are not, the signal will be distorted.

Much is a matter of commitment. Recently, Sanfratello came up with a modification which he says makes even the most technically impossible tapes viewable over cable. The part for the modification cost fifty cents. *

A uniform characteristic of all of the groups and individuals doing half-inch programming for the public channels has been commitment. With few exceptions, people doing Public Access programming receive little or no pay. Most of the groups have had philanthropic support. Open Channel, organized by Thea Sklover to provide taping facilities and personnel to groups wishing to put programming onto the public channels, got started with a \$19,000 grant from the John and Mary R. Markle Foundation and a \$15,000 grant from the Stern Fund. Open Channel has taped with more than eighty requesting groups and organizations, and has more than that waiting. They have also done some of the most ambitious public channel programming, including a two-and-one-half hour "special", a music service from a black church in Harlem. Alternate Media Center, at New York University's School of the Arts, also received support from the Markle Foundation, with a grant of \$275,000 to be spread over three years for the purpose of promoting community and non-professional use of the cable via half-inch video. The Center is run by a woman named Red Burns, who, with students and paid professionals, has been helping groups around the country as well as in New York to create their own capability to produce half-inch video programming. In general the Center contributes the technical know-how and cable experience, and the groups find their own funding for equipment, tape and other expenses. The Center is in the process of organizing a Public Access video center for Reading, Pennsylvania, the first one to be funded by a cable company (Berks TV Company, a subsidiary of American Television and Communications, the nation's third largest CATV company in number of subscribers). The Center will train resource people for one year, then leave it to the people of the community to run.

Two of the best series of programs on the public channels received funding from the Fund for the City of New York, through its Center for the Analysis of Public Issues. One is a series for and about old people, called "The Elders; programming includes an exercise class taped at an old people's center, a nutrition discussion group, and a discussion of an old people's rights movement with Bella Abzug. The series was produced by David Othmer and taped by students from the Alternate Media Center. As with the programming of other special interest groups, these tapes have had an audience, and the response has been strongly enthusiastic. The other series was done for the signing deaf, those who use sign language, produced by the Deafness Research and Training Institute, a federally funded rehabilitation center affiliated with New York University. The series includes a cooking class, some panel discussions on problems of the deaf, and an excellent tape on how to use half-inch videotape equipment, made with Frank Cavestani at Space Videoarts, which has received support from the Samuel Ruben Foundation.

Considerable programming, some of the most varied and creative, has been done by people in the so-called "underground" video groups in New York: Global Village, Peoples Video Theater, Raindance, Space Videoarts, Videofreex. Their commitment to and development of half-inch videotape as an alternative to our communications system pre-dates Public Access by several years and has been of the greatest significance to its development. All of these groups have received funding from the New York State Council on the Arts, but, since the non-commercial use of half-inch video is for the most part also non-remunerative, most of the people involved live and work on a shoestring. Although they have sought foundation support, few of the groups have received it, despite the fact that their accumulated body of work is impressive. One reason why they have not received foundation support may be that their commitment to alternatives includes their own life-styles, and this may be misleading to foundation people.

One very encouraging aspect to the Public Access financial picture is that much has been accomplished on relatively little. But it is clear that, if Public Access is to have a chance to be experienced by our communities, in order to be valid even as an experiment, it will have to have a substantial commitment of money and people, probably from philanthropic, commercial and government sources.

* The part was a capacitor, inserted into the Automatic Gain Control to subdue its tendency to overreact to signals from half-inch tape (including a 60-cycle hum which is often present).

Red Burns, Alternate Media: "One of our principal concerns is the whole problem of deconditioning people from the assumption that they have no access to media, and that they cannot deal with it... What we've come around to believing and understanding is that it's terribly necessary for this video equipment to be available on a community basis. (But) we don't have enough money, and I don't think any foundation would have enough money, to give everybody video equipment. So we don't go around turning everybody on to video, saying, 'Hey, isn't that nice!', and then leaving... We have evolved a way of working in which we attempt to set up projects which can be self-generating. We will go in with resources to begin with and any kind of expertise and advice that we have learned and then it has to be taken over by the community... Our concept is based on the fact that there are resources available in the communities, but that the resources will not be made available until the communities get into the idea of the use of the equipment... So initially we're trying to find ways to provide money, whether it's the cable companies who are into the possibility of making a contribution, or community planning boards, community colleges, or neighborhood groups....."



As we go to press, Sterling-Manhattan Cable announces the formation of a free access studio for production of video tapes. Portable video recording equipment as well as editing facilities will be available on a first come, first serve basis. Its location will be announced in the near future. Hopefully, this example will set a precedent for other cable stations around the country.



I have mentioned in this article some of the areas in Public Access which need work. Obviously, most of these areas will require funding, sometimes not very much, to get the job done. In addition, the following are only some of the other ways in which Public Access might be assisted:

1. Video access centers staffed with people to teach non-professional, non-commercial groups and individuals who wish to do their own Public Access videotaping how to use portable half-inch equipment. The center would need to be equipped with half-inch cameras and recording decks (total cost of each set-up: about \$1300 with discount), videotape, and a part-time repair person to keep the equipment up to cable-use standard. Expenditures for testing and repair equipment and rent would also be necessary.
2. Literature on how to use half-inch video equipment, simply written and illustrated, so that it would be useful to people with a wide range of educational backgrounds, with specific instructions for cable-use.
3. A Spanish-English version of the same.
4. A "spot" advertisement on commercial television, informing people that Public Access exists for their use and viewing, and how they can use it. Also bus and subway posters in cities, bus-stop and train-station posters in the country, with the same information. Newspaper display ads carrying use and viewing information.
5. A research project, to be updated at intervals, on techniques for improving the use of half-inch over the cable. The project should include a survey of all cable companies using half-inch on their own originating stations, and it should set up a system for the ongoing exchange of such information. There should be an inexpensively printed handbook of the research results, sent out to everyone involved with Public Access.
6. Franchise acquisition. If a number of foundations could pool their resources to acquire a franchise, then set about to establish a model cable system with fully developed Public Access facilities, that system could greatly influence the development of CATV as well as Public Access.

These suggestions just scratch the surface of the ways in which funding could be creatively integrated into the Public Access situation.

An involvement with Public Access really is an involvement with change. Some foundations have been debating the question of whether or not to directly involve themselves with making changes in our society. But it would seem that the question is not realistic. In reality, life IS change, and a live society is continuously changing. There is no way NOT to participate in the process, hence the question should be: what do we want the meaning of that change to be? Or: who are we who make these changes?

Technology is really nothing—a piece of equipment lying around—until somebody picks it up and uses it. And it is what we choose to do with it, which is to say, WHO we are who use it, which determines the effect of our technology upon us.

Cable technology has within it the possibility to hasten along a day when "big brother" is indeed "watching you", aided by a total system of two-way, individual access cablevision—into our homes, our bank accounts, our business transactions, where every TV set cablecasting the football game in the local bar can be transmitting our conversations and actions as well.

It also has the capacity to let us talk to each other, people who, in an earlier time, might not have been able to understand each other or to care, who might have been too frightened to listen to each other face-to-face.

We have a chance to witness the excitement of our own beings, our own lives, REAL people, not plastic people, with words we really mean coming out of our real mouths.

Do we want it? We can have it. Of all the promises of cable television, it is the most immediately realizable. It is here—but to grow it must have our commitment.



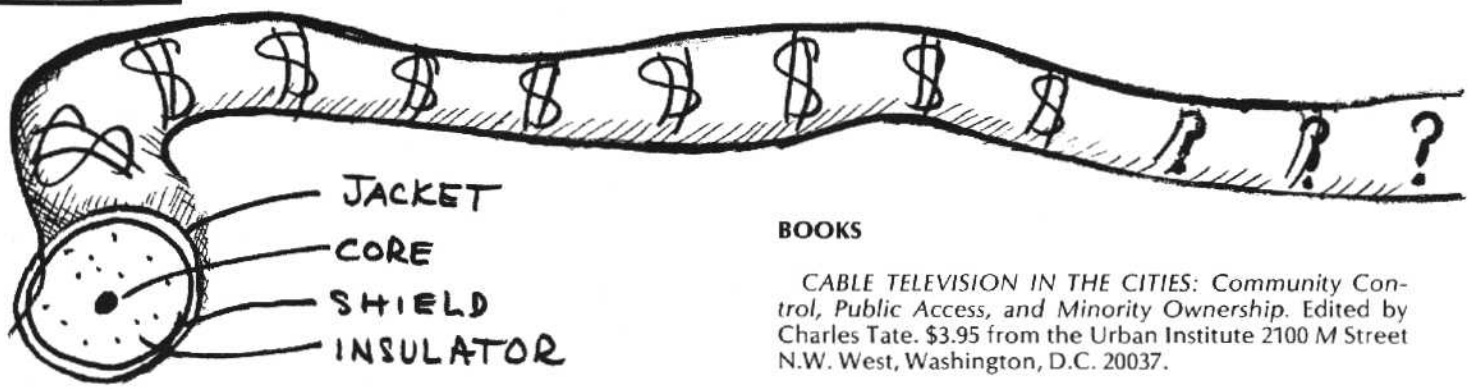

Over the last six months there's been an explosion in cable-TV activity ranging from useful books to a national office devoted exclusively to providing non-partisan information about CATV. Here is a list:

CABLE TELEVISION INFORMATION CENTER

This is a three-year project funded by the Ford and Markle Foundations (at \$950,000 per year) to provide information to municipalities and community groups about the options available to them in granting and getting a cable franchise. According to Bowman Cutter, the Center's director, the information will range from simply answering questions to drafting feasibility studies and beyond to the point of assigning field workers to become actively involved in cable negotiations. Although the Center has just been in existence a short time it's already received over 200 requests for assistance from various city governments.

Cutter is a 29-year-old businessman with no previous experience in either cable or any facet of public (or private) television. Prior to his appointment he was an executive with the Chicago-based Northwestern Industries Conglomerate (and also taught in the business school at the University of Chicago). More important, he was campaign manager for Senator Adlai Stevenson and thus brings with him high-use knowledge about city- and state-level politics. Forty percent of his staff (of ten) will spend their time in the field and Cutter says that he is choosing them for their political savvy as well as their knowledge of cable.

While the Center is not conceived as a policy-making group, Cutter says it will offer both opinions and straight information. Moreover, he plans to stay in touch with successful cable projects to draw off their resources in advising other communities. This might lead to a library of successful videotapes so that nascent cable systems can see the potential of the medium through the medium itself rather than print and talk.

Cutter offers assurances that the Center will not function as an arm of the Ford-Public Broadcasting axis in an attempt to establish domination over cable-TV planning. In fact, he says, his liaison with them is informal and infrequent. From talking with him it becomes clear that his background in business and politics may be just what's needed in the position he fills. Where he may be weak is in understanding the programming potential of cable and thus it would be a good idea for people with practical experience to make contact with the Center and pass on print and video information. The address is:

Bowman Cutter, Director
 CABLE TELEVISION INFORMATION CENTER
 2100 M Street N.W.
 Washington, D.C. 20037
 Phone: (202) 872-8888

BOOKS

CABLE TELEVISION IN THE CITIES: Community Control, Public Access, and Minority Ownership. Edited by Charles Tate. \$3.95 from the Urban Institute 2100 M Street N.W. West, Washington, D.C. 20037.

This book didn't cost \$500,000 to produce as did the Sloan Commission Report, but it's about 500,000 times more useful. In fact, it may be the best single resource book about cable-TV including as it does a bibliography of relevant publications, a list of research and demonstration projects, useful facts about the cable industry and the F.C.C.; and a rundown on the people in congress who sit on committees effecting cable.

More important, *CABLE TELEVISION IN THE CITIES* has a point of view—that minorities and community groups should control cable—and thus configures its information towards that end (there is even a list of community owned systems) right down to work-sheets which would enable you to make a practical estimate of your communities needs both in wiring and video production.

While the book is weak on programming ideas and the need for high flexibility video equipment, it is so comprehensive and fortunately non-theoretical that its use value can't be stressed enough. If your community is considering cable then get this book.

ON THE CABLE: The Television of Abundance. Report of the Sloan Commission on Cable Communications. McGraw-Hill (paperback). \$2.95. This book should be studied as a document in political science or sociology, because as an overview of cable it is of trivial important (see first article, this section).

What is important are the insights to be gained into the mentality of the foundation establishment which would pay \$500,000 to produce this document. Cable will change the nation, the Sloan Commission claims, but their claim is so devoid of exuberance or imagination that you wonder "why bother?"

It is of critical importance to understand that the drafting and appearance of this report was a major event deserving of full national coverage only because it reconfirms a traditional power pattern (foundation-report-publicity-maybe action), not because it had much to say. Thus, the foundation establishment used cable television to reassert its influence at a price of half a million collars while people actually working towards "the television of abundance" are for the most part without funds or organizational support.

Indeed, the most critical failure of the Sloan Report is that it offers no notions of how to integrate public access and other alternative types of programming into the economic life of cable systems. Yet, there will be no fundamental structural change in communications unless there are alternative ways of funding. Foundations are notorious for their lack of economic innovation, probably because they themselves never have to worry where their funding is coming from. Thus, the Sloan Report is preoccupied with guaranteeing cable operators unlimited access to imported broadcast signals (i.e. more of the

same old stuff) because that will make them financially healthy and then maybe they'll get around to those other innovations "which is what we really want to see."

In this context, public access becomes like "public service:" those bullshit shows that the networks do on Sunday mornings that people don't like, but which are "good for them." Or it becomes another stab at NET, i.e. a second chance at educational television, only this time they think, maybe they'll get it right.

At least the folks at Children's Television Workshop, which brought you *Sesame Street*, must think so. CTW is now an integral part of the "what's going to happen with cable" scene and their spokesman is Mike Dann, formerly of CBS, who stars in Les Brown's book *Television* as the ultimate cynic, a type of man who programs crap for money, but who wouldn't watch him it himself.

Sure, we all know that "Dann never really wanted to do that stuff, that is talents are needed now in non-commercial teevee", blah-blah-blah, but like it or not *Sesame Street* is just another power structure controlling kid's lives with enormous resources and influence and no outside inputs. You probably didn't know it, but the CTW moguls like to spend occasional weekends at executive type retreats in the mountains having what can only be described as "secret" meetings to determine how they'll influence cable-TV.

COMMUNITY ACCESS VIDEO, by Herbert Allan Frederiksen. \$3.00. Available through bookstores or from the author at: 695 30th Avenue, Apartment#E, Santa Cruz, California 95060.

Portions of this book are excerpted in this *Radical Software* along with an order form if you can't get it from your bookstore right away. We say "right away" because this is *the* most useful book available on making your own television. It has that detailed description of how to acquire and work with video equipment (editing, cabling, shooting, etc.) that everyone else always talks about writing and/or needing. It has a fine chapter on "Forming Your Own Non-Profit Corporation for \$20;" and a glossary of video terms unique to Porta-Pak production; suggestions as how to make money to support your own video, and finally, much information on gaining access to cable-TV.

The author is working in Santa Cruz, California trying to set-up a public access facility. Because the city did not specify public access in the original franchise agreement (with Teleprompter) Frederiksen has had to organize a community referendum on the issue. But even though he has gotten the required signatures the city government may refuse to hold the ballot arguing that it would be a breach of contract with the cable system. Thus, Frederiksen is prepared to take the matter to the California Supreme Court which could then establish a precedent by ruling that even though a cable franchise is in effect without broad-ranging public access, the community can go back and rewrite it. This would strike down what's called "grandfathering" where existing cable systems attempt to avoid liberalized access rules by claiming that their contract was in effect before the rules were issued. (Just as blacks in the south couldn't vote if their grandfathers hadn't. Hence the term). Needless to say, Frederiksen details all his experience in organizing Santa Cruz in the book.

It should be noted that Frederiksen is doing his whole trip without any outside support, at a time when foundations are spending hundreds of thousands of dollars and study projects and meetings. Moreover, the author had to pay to publish his own book (\$900 for 3,000 copies, first-run), a book which is infinitely more useful than the \$500,000 Sloan Report.

CABLE TELEVISION, by Monroe Price and John Wicklein. Pilgrim Press, 1505 Race Street, Philadelphia, Pa. 19102. \$2.95 paperback. \$5.95. hardcover.

Monroe Price is co-author of the Sloan Report, but don't hold that against him. While this book doesn't have the grass-roots feeling of Frederiksen's, or the pragmatism of *Cable Television in the Cities*, it is still a high-use addition for a good knowledge of cable.

THE F.C.C. RULINGS ON CABLE are available for only 20 $\frac{3}{4}$ a copy by writing: Superintendent of Documents, General Post Office, Washington, D.C. 20402; and specifying: Federal Register of February 12th, 1972, #30, part two only.

In brief, the F.C.C. has adopted a laissez-faire attitude which obviously reflects Chairman Dean Burch's brand of Republicanism. However, instead of keeping hands-off the public input as well, the rulings restrict it and thus amount to a form of protectionism.

Specifically, the rulings state: "There remains the issue of whether also to permit State or local regulation of these channels (public access) where not inconsistent with Federal purposes. We think that in this area a dual form of regulation would be confusing and impracticable. Our objective of allowing a period for experimentation might be jeopardized if, for example, a local entity were to specify more restrictive regulations than we have prescribed. Thus, except for the government channel, local regulation of access channels is predicted . . . We will entertain petitions and consider the appropriateness of authoring such experiments (as expanded public access)."

Quite simply, this means that the F.C.C. has screwed Public Access. While it does guarantee one channel, it actually forbids a local system to make more available without federal permission. This means, for example, that the New York City agreement would not have been possible if it were arrived at after these rulings. While the F.C.C. might retort that it is open to modification of the rules, it becomes an added burden on the part of community groups to have to petition the government for expanded access.

That the government has declared hands off on the business end, but then turns around and stifles legitimate public interest, is representative of the type of action that gives conservatism a bad name. Clearly, it seems, the government is still afraid of open access to the channels of communication in America.

(On the positive side, however, the rulings do specifically mention and encourage the use of half-inch video equipment and very clearly state that there will be no technical standards imposed on non-broadcast signals carried over the cable. In other words, technical standards will not be used as a form of censorship as they are with broadcast television.)

BUSINESS

Cypress Communications based in Los Angeles has indicated it would be interested in buying alternate types of video programming. Address inquiries to: Leon Papernow, Vice-President, Cypress Communications, 10880 Wilshire Blvd., Los Angeles, California 90024

For an interesting overview of why cable-TV is a good financial investment and which of the companies to invest in request the report from: Source Equities, 160 Broadway, New York, New York 10038.

The *PUBLIC ACCESS NETWORK* is apparently a complete hype being pur across by a company called Quantum Communications, 3051 Adeline Street, Berkeley, California. Their scheme is to offer cable systems a local

origination service wherein Quantum would train community people in the operation of video equipment, supply hardware and programming concepts. Initially, community people would have to leave their communities and come to Berkeley for training. Quantum says it will guarantee a cable system two to four hours of locally produced material each day, as well as another four hours of imported programming, the scheme being to swap programming among the systems that Quantum is working for. Quantum estimates the cost to a cable system of say 6,000 subscribers as 2¢ per subscriber per day, or \$43,800 a year, which is a lot of money; money which should not be diverted from direct investment into a community.

Basically, a centralized service for local programming is self-defeating. Communities needs differ. If there is local money available from a cable system to do programming to give it over to outsiders is a blatant rip-off. Moreover, Quantum seems to be interested in providing only heavy production equipment, no portable stuff, and thus declaring itself an expert—the same old game.

The California company announced their plan at a news conference in February. Prior to the conference, we called them and asked about their scheme. Every specific question of ours was diverted with the explanation "we can't answer that now." At the actual press conference Quantum was even more vague (we have a videotape of it) which caused the covering press to get hostile at Quantum's obvious lack of any real information.

Our feeling is that Quantum is trying to grab publicity through premature announcements because it wants to be first on line for potential federal funding in this area. The company claims to have lined-up some prestige names on its advisory board, and those people should know better. Specialized national networking through cable is to be encouraged, but the last thing that local experimentation needs is a packaged plan—the same for everywhere. If Quantum is hustling your community, keep a close watch on them.

PROJECTS

Alternate Media Center (144 Bleeker Street, New York, New York 10012) is a projected funded by the Markle Foundation (for \$260,000) to explore community-oriented uses of cable. The Center's projects encompass New York City; Cape May, New Jersey; Reading, Pennsylvania; Charleston, West Virginia; Baxter, Tennessee; Montpelier, Vermont; Gulf Coast Pulpwood Cutters, Mississippi; Rice University Media Center, Houston, Texas; and Wooster, Massachusetts.

Alternate Media is into training people in the techniques and technology of half-inch video and working with cable owners and managers. In essence, it is a training project for people in public access cable-TV.

The Center runs a no-fat operation without fancy furnishings and phony secretaries. Just video and community organization. The directors, Red Burns and George Stoney, are both practical-minded people who know what to avoid in trying to create genuinely responsive alternatives in cable.

The only drawback of the Center, which is in no way the fault of those who run it, is that it serves as a "safe" project for foundation-type funding. That is, Alternate Media does many of the same things that individuals are who have no support are also doing. But because Alternate Media is affiliated with N.Y.U. it has a legitimacy that the rest of us do not.

We once tried to get a small grant from the same Markle Foundation and were informed that they had given "all their half-inch money" to Alternate Media. Other people report similar experiences. Our project was to do a technical mini-manual on half-inch video interfaced with cable-TV. We wanted only about \$5,000. But because of projects like Alternate Media Center there is no small-sca-

le money left for diverse groups who don't need or want brokers in their work. Afterwards, we also learned that it doesn't pay for big-time foundations to give small grants because of their overhead. In other words, it costs them the same in administrative expenses to give away \$50,000 as it does to give away \$5,000, so that thinking small doesn't interest them while at the same time they are encouraging decentralization of social systems.

Open Channel, 49 East 68th Street, New York, New York 10021. Thea Sklover, who is head of Open Channel, has been working towards genuine alternatives in television since well-before the half-inch video scene developed. Her integrity and motivation are above question and she has been tireless in her efforts to guarantee public access on the legislative level. But she has some strange ideas.

Open Channel functions as a middle-man between the Public Access channels in New York and community groups who want to produce programming but who don't have skills or equipment. This puts Open Channel in a brokerage position and what's particularly frustrating is that there are people in New York who think that Open Channel and Public Access are the same thing, a notion developed through extensive publicity that Open Channel has gotten in both local newspapers and national magazines. At a time when the head of the F.C.C. himself has said publically that Public Access (in New York) isn't working, it's a dangerous game for only one group to be its spokesman.

Moreover, Open Channel is committed to notions of production which merely mimic broadcast tveevee, although using portable equipment. Thea maintains that the groups she is working with are used to certain production standards and merely want to see them applied on local news and events. Well, no one argues against well-produced tape and there is no reason to tolerate bad camera work, bad sound, or bad edits. But the techniques of broadcast television are also formatting devices which have proved unable to communicate honest, straightforward information. The alternatives of well-produced portable video guarantee access to behavior more genuine than street interviews and performance functions.

One of *Open Channel's* prize tapes is of a church service in a black church. Two-and-a-half hours of engaging energy that, however, took Open Channel 20, repeat 20, people to produce. What's ironic, is that an essentially white, middle class group is using the vitality of black culture to demonstrate what Public Access can do, while being unable to record similar enthusiasm among themselves.

Indeed, Open Channel's headquarters are an office scene, five or six women at typewriters and one man in the corner, with no more space than a desk, to look after the actual equipment.

As another experiment, Open Channel is to be encouraged, but not as the broker for Public Access television. It is important for the outside world to realize that Open Channel's approach is but one of many.

CONFERENCES

CHALLENGE FOR CHANGE AT N.Y.U. took place November 21-23, 1971. It brought together fifty participants from New York State and a resource team from the "Challenge for Change" unit of the National Film Board of Canada, which has pioneered in community and minority participation in film and half-inch video.

The formal discussion consisted of film and video showings and a series of discussion groups and workshops. Video and audio tapes of portions of these discussions are accessible through the library of Alternate Media Center, 144 Bleecker Street, New York, N.Y., as is a written summary of what was said.

THE NATIONAL CABLE TELEVISION ASSOCIATION held a conference ostensibly for college students in Washington on February 11th of this year. The program included speakers from the F.C.C., including Dean Burch, some people from the cable industry, and individuals deeply concerned about cable like Ted Ledbetter of the Urban Communications Group.

As conferences go, the format proved highly successful. Instead of dull panels it was mostly question and answer and at times quite provocative. When Burch claimed that public access in New York was not a success, George Stony of Alternate Media Center spent several minutes rebutting him with a wealth of details about the problems that we've had in New York (e.g. landlords won't give the systems access to their buildings, the buildings don't have cable, people who can use public access have no way to watch).

Apparently, there was some dissension within the N.C.T.A. about having the conference, some of the board members arguing that college students had nothing to say to them. Unfortunately, the N.C.T.A. had nothing to say to college students, so that the trade organization learned a lot about what people are thinking, but in return we learned nothing about where cable owners are at, as the kids say. That was frustrating because we obviously

have to work with those people, not alienate them, and we have to understand what their concerns are. There may be another chance this May, when the N.C.T.A. holds its own convention in Chicago. Some folks in New York are talking about going. If you're interested you might contact them through Alternate Media Center.

POLICY MAKERS CONFERENCE ON URBAN CABLE COMMUNICATIONS "Your Invitation to Study Cable Communications for America's Urban Environment" was held January 25 and 26 in Dayton, Ohio, and we'll bet you probably didn't know about it. Well, about 500 people including city officials from all over the country came to hear discussion about the plan that Rand Corporation drew up for wiring Dayton and also hear endless panels on other facets of cable with subjects like: "Emerging Minorities" and "Response to Social Needs."

Basically, the Dayton plan suggested that the city itself be part of a single system including surrounding municipalities. Funny thing was that Dayton's high-density areas (most profitable for cable) are mostly black, so that by including white suburbs in one system the black community was in essence subsidizing cable TV for the whites. Well, they decided uh-uh, and now the Omniscient Rand Corp. is going to cable conferences and lecturing on "Lessons from the Rand Study of Cable in Dayton, Ohio." Needless to say, there was minimal input into this conference from any of the people actually working at the programming level.

An odd trend seems to have developed among the social planners in America: black and other minorities operating out of self-interest are now not just acceptable, but desirable, but a white minority group, i.e. middle class whites who want an alternative to the dominant life style, is given no legitimacy. The reason probably lies in the fact that the planners themselves are white m.c. and thus become uneasy when people with similar backgrounds act on them in a much different way.

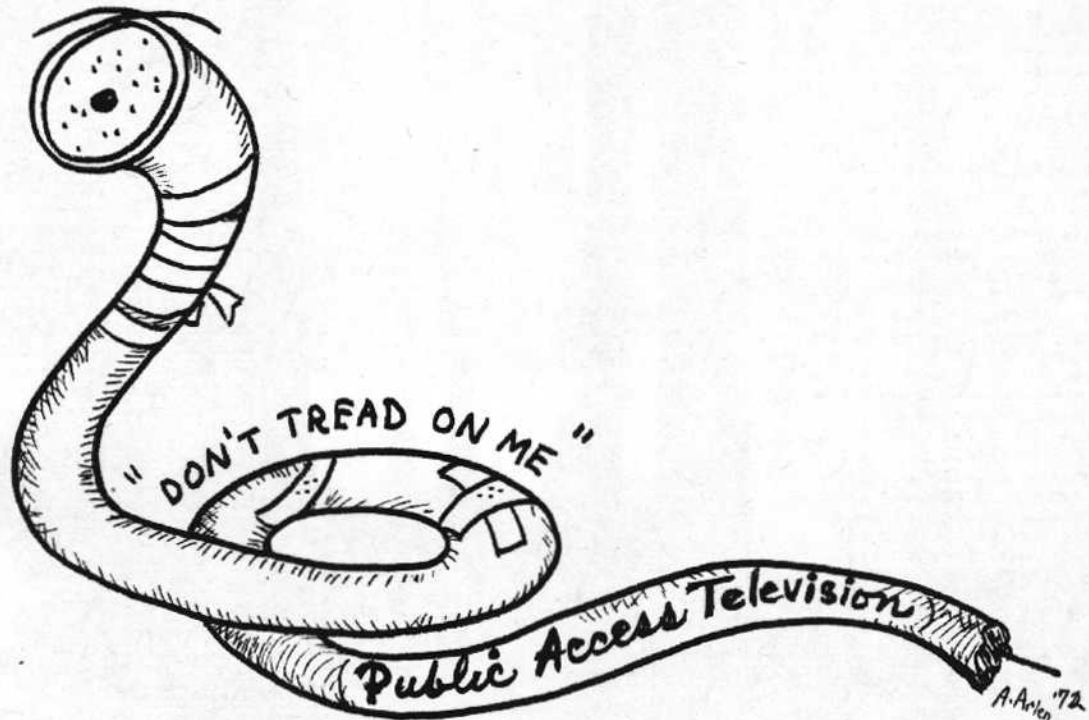

Woodstock

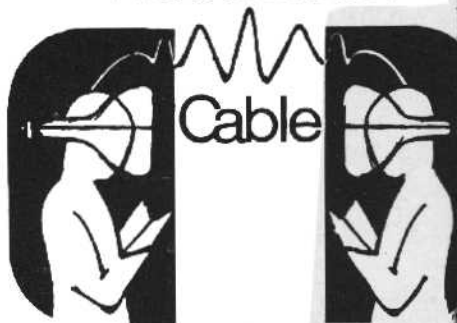

Woodstock could have its own community cable TV channel doing its own programming on a regular basis. It is with this in mind that the following has been written. Read it, consider it, and join Woodstock Community Video in this effort.

When television first began, a cable system was rejected because of the high costs for installation and the need for public dollar support. So airwaves TV, governed by the Federal Communications Commission, owned by capital, supported by a new message-making elite (advertisers), turned into an entertainment medium which the public supports anyway, by paying overhead costs on consumer products and by losing tax revenues from company profits spent on advertising, for all advertising expenses are tax deductible.

Since the airwaves provide a maximum of seven channels in an area about 1600 square miles, the FCC allocates them to serve the majority, not always guaranteeing service for everyone in every place. So cable is used. By setting up a large antenna to receive distant airwave signals, and from that antenna running cable to home sets, TV can be had by any. Per coaxial cable used 20 to 40 signals can be carried. So there's space also for locally originated messages sent from headend studios in the system. Cable can be two-way. Cable can filter signals to certain sets and block others. That's how AT&T's picturephone and pay-TV systems work. Eavesdropping devices can be attached to cable just as to telephone.

The FCC sets technical standards related to the strength of signal for using the airwaves. Whereas airwave production technology is at the cost of small airplanes, cable production technology is at small car costs: two-inch videotape decks and large studio cameras as opposed to one-half-

inch portable video decks and hand-held cameras; two-inch tape costing \$200.00 per hour, half-inch tape \$30.00 per hour.

FCC controls of programming are based on two conditions of the airwaves: 1) limited number of message routes; 2) indiscriminate exposure to everyone. What is allowable must have majority appeal. Censorship must be implemented to guard that majority from libel, sedition, riot, and obscenity. Many special interests in a democratic society are not served; cable with its multi-signal capacity allows for controlled exposure and enough message routes for dare say all interests. But it, too, has been limited and a burden of liability put on the cable owner. The FCC, as well as proposed state and local authorities, are questionably exercising controls over cable.

Cable is usually put in under locally designed franchises for fees. The cable owner charges an installation cost and monthly subscription fee. For this he maintains the antennae and cable to provide distant and near airwave signals for better reception. He expends efforts in behalf of locally originated programming. He can lease channels. He can sell advertising. He can offer access to pay TV systems. He can be freed of the burden of liability of program content. He should be responsive to his subscribers because of the economic relationship between them. He can provide the community with its own conveniently-located studio and channel(s) and help support it by a return from subscription fees.

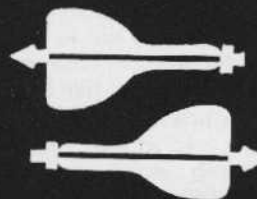

WCV

Community Programming

Community message-making succeeds when it is supported by the community and when all of us participate in the flow of information: the statistics, the news, the special events, the documentaries, the sports, the entertainment, the talk shows, the arts, the issues, the answers, the advocates, the opposition, etc. Within our community are the resources for all aspects of our survival and each and every person is a trustee of some information. We are the information: the businessmen, the politicians, the doctors, the lawyers, the police, the firemen, the students, the teachers, the workers, the artists, the musicians, the performers, the bankers, the grocers, plumbers, electricians and builders, the housewives, the summer residents, the children, the old people, the street people, the media people, etc.

All of us have roles we've elected to play and all of us are just people who live in this town. We have needs to express ourselves in and out of our roles. We need to advertise, promote, advocate, oppose, sing, dance, show, tell, converse, accuse, defend, gossip, proclaim, challenge, inform, question, answer, etc. There's nothing new about all that.

Cable, however, is a tool to vitalize the processes of our town's communications--a needed vitality for a time of complex and varying social values and problems. Our local TV can reflect that vitality.

KINGSTON CABLEVISION, INC.

Kingston Cablevision is owned by NBC. Under present FCC guidelines broadcasters who own cable are to divest those interests by spring, 1972. This ruling is being challenged. The total system is made up of the Northern Dutchess County area, Ulster, Rosendale, Kingston, and Woodstock. According to Mike Fisher, the company's Program Director, there are presently about 12,000 subscribers, approximately 1,000 in Woodstock during the winter off-season. The antenna for the major part of the system is located in Port Ewen on 9W with the company's small studio and offices, under the direction of Tom O'Keefe, the on-site executive. The subscription is \$5.95 per month with varying installation fees depending on home location. Woodstock is serviced by a separate antenna on Mead Mountain not presently linked to the Port Ewen headend. Woodstock, therefore, doesn't receive the community programming produced by Kingston Cablevision. Presently there are no services beside cable reception of FM radio and VHF airwave TV channels from New York City, Hartford, and Albany. The company is anticipating a 20-channel two-way capacity cable in the Kingston area within the next two years. As to more complete services for Woodstock, the company anticipates a micro-wave or cable link to connect the two systems once the 20-channel capacity is established. A community channel for Woodstock is being considered: a studio headend conveniently located in Woodstock is not.

Presently Kingston Cablevision's community programs are seen on Channel 2 about 14 hours a week, to increase to 21 hours by March. To date, there's no advertising nor charges or payments to persons or groups who are

subjects of programs. The three-person program staff has both $\frac{1}{2}$ " and 1" video facilities and a remote capacity for out-of-studio coverage of events. The subjects of programs are sports, cultural groups, political action, etc.

Woodstock Community Video

WCV started around the 1971 Town elections. Many witnessed the ashcan monitors on the streets and in the Grand Union showing and asking Townspeople about the candidates. With a New York State Council on the Arts grant to the New York City based People's Video Theatre, Inc., Woodstock was chosen as a locale for the development of community video. Half-inch video equipment and tape, a small operating budget, and two video people (Ken Marsh and Elaine Milosh) joined forces with a local artist (Bob Dacey) and have been operating out of a donated storefront, thanks to Ron and Valma Merians at Joyous Lake Restaurant.

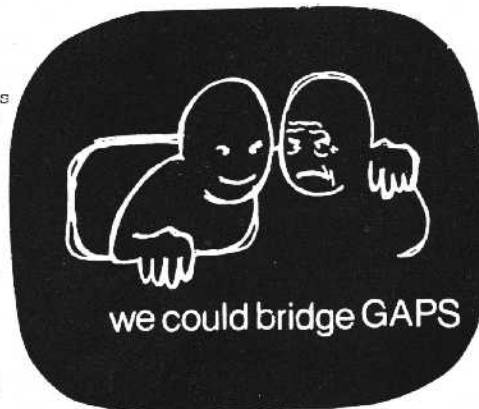

WCV has been providing closed circuit TV programs out of the storefront studio on weekends. Regular reports from the Town Clerk, Family, the police, etc. have been shown. WCV has created the Scoopscope, a video bulletin board for community use; Negapositube, programs on community issues; and Channel Arts, for the talent of Woodstock.

WCV is a public enterprise capable of providing the town with community message-making facilities via closed-circuit equipment on the streets and in meeting places and with

cable the expertise and programming for a Woodstock Community Channel. WCV can provide low-cost advertising for local businesses. WCV can be a way for sponsors to support low-cost production of programs for schools, churches, social groups, etc. WCV can be the recipient of partial

cable subscription fees turned back to the community for its own channel operations. WCV can market valuable Woodstock information to other community cable channels throughout the country and abroad. WCV can be an economically self-sustaining enterprise bringing 21st Century media potentials to Woodstock.

Technical aid has already been given by John LaValle of Sight and Sound and Morty Schiff. Additional equipment has been donated by Robert Kaplan and the Videofreex. The Woodstock Artists Association is sponsoring WCV meetings starting Thursday, February 3rd and for eleven Thursday evenings thereafter. Programs will feature tapes on the arts, history, and topical issues of Woodstock and Live Forum tapings with audience participation. The first meeting will deal with community video and cable. WCV proposes, in order to expedite the creation of a Woodstock community channel and studio that:

1) The Town Government: a) reassess the franchise it has granted to Kingston Cablevision in order to find some leverage to bring to bear a guarantee of complete cable service for Woodstock; 2) proclaim WCV as an official representative of the Town concerning video and cable communications with authority to receive subscription fee returns from Kingston Cablevision; and 3) allocate permanent space as the headend-studio and WCV headquarters for the Woodstock community channel in Town Hall.

2) The churches, schools, and other groups begin to create programming for the community, working with WCV in the formulation of message making for their special concerns and audiences helping to locate sponsor support.

3) You the people subscribe to the cable and come to WCV events. As subscribers let Kingston Cablevision know you want a community channel for Woodstock with its studio (headend) in Woodstock at Town Hall, and that you desire to see a minimum of fifty cents per subscriber a month be returned to WCV to support the channel.

WCV and Community Channel are a natural for us.

◦ THE APRIL VIDEO CONFERENCE & JAMBOREE ◦

APRIL 21-22-23
LIVINGSTON COLLEGE
NEW BRUNSWICK, N.J.

FACILITIES PROVIDED BY/
THE VIDEO COLLECTIVE &
THE URBAN COMMUNICATIONS
TEACHING & RESEARCH CTR.

WHAT IT IS: A CONFERENCE OF 1/2" VIDEO-ORIENTED PEOPLE COORDINATED BY AN ECLECTIC ASSORTMENT OF INDIVIDUALS, SOME OF THEM FROM (IN ALPHABETICAL ORDER TO DATE):

- THE ALTERNATE MEDIA CENTER, N.Y.
- COMMUNITY VIDEO CENTER, WASH.
- FOUNDERS ANNEX, MASS.
- PEOPLES VIDEO THEATER, N.Y.
- RAINDANCE, N.Y.
- THE REVOLUTIONARY PEOPLES COMMUNICATION NETWORK, N.Y.
- THE RICE MEDIA CENTER, HOUSTON
- THE SCHOOL OF EDUCATION (U. OF MASS.)
- THE VIDEO COLLECTIVE, N.J.
- CINCINNATI VIDEO SOFTWARE, OHIO

WHY: ON FEB 11 THE NATIONAL CABLE TELEVISION ASSOCIATION SPONSORED A NATIONAL COLLEGE CONFERENCE ON CATV IN WASHINGTON. BILLED AS AN OPPORTUNITY TO QUESTION THE "POLICY MAKERS" ON PUBLIC ACCESS AND CATV, THE SESSION ATTRACTED MANY PEOPLE ALREADY INVOLVED IN VIDEO & CABLE WORK. A GROUP OF US, WHO CAME AWAY WITH A STRONG SENSE OF THE NEED TO GET VIDEO-ORIENTED PEOPLE TOGETHER NATION-WIDE, MET AT THE ALTERNATE MEDIA CENTER

ON FEB 23. OUR GOAL WAS TO PLAN A CONFERENCE IN WHICH PEOPLE COULD COME TOGETHER, FIND OUT WHAT'S BEEN GOING ON, AND EXPLORE A COMMON SENSE OF DIRECTION.

WORKSHOPS ARE BEING PLANNED ALONG LINES OF INTEREST & NEED. THE DEGREE OF PARTICIPATION AT THE APRIL CONFERENCE WILL DETERMINE THE ACTUAL STRUCTURE OF WHAT HAPPENS AND WHERE WE'LL GO FROM THERE. IN THE MEANTIME FEEDBACK FROM THIS ANNOUNCEMENT CAN HELP US TO DETERMINE IF MORE WORKSHOPS SHOULD BE ADDED OR SOME DROPPED. THERE ARE HUNDREDS OF GROUPS & INDIVIDUALS AROUND THE COUNTRY GETTING INTO THE SAME THING - AND RUNNING INTO THE SAME SITUATIONS. IT'S TIME WE GOT TOGETHER.

BRING: TAPES & PORTABLE HARDWARE
TAPE CATALOGUES (w/ DESCRIPTIONS)
SLEEPING BAGS
MUSICAL INSTRUMENTS
BREAD FOR BREAD

WE HAVE: VERY BASIC SHELTER
EQUIPMENT STORAGE SPACE
CAFETERIA / SNACK BAR SERVICES

HOW TO GET THERE:

BUS: GREYHOUND, TRAILWAYS, SUBURBAN TRANSIT FROM N.Y. PORT AUTHORITY TERM.
TRAIN: PENN CENTRAL / AMTRAK TO NEW BRUNSWICK.

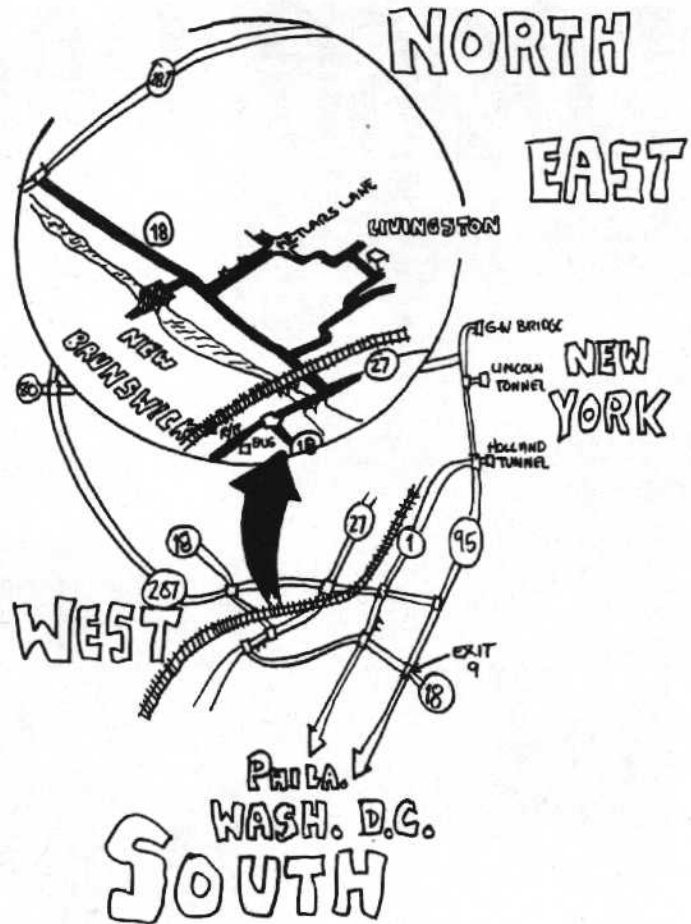

CAR: N.J. TURNPIKE (95) TO EXIT 9, RT. 18 WEST
ROUTE (1) TO RT. 18 WEST
FOLLOW 18 W TO NEW BRUNSWICK

REGISTRATION FEE OF \$5. TO DEFRAY COSTS
WILL BE GRATEFULLY ACCEPTED.

WHETHER OR NOT YOU CAN ATTEND WE'D LIKE
YOUR INPUT PRIOR TO THE CONFERENCE IF
POSSIBLE. LET US KNOW WHAT YOU'RE INTO
AND WHAT YOU NEED - ALSO WHAT SOFTWARE
YOU HAVE AND MAY BRING.

EMERGENCY PHONE (APR. 21-23) (201) 932-

----- CLIP OR SEND FACSIMILE -----

WRITE: LIVINGSTON VIDEO CONFERENCE & JAMBOREE
THE VIDEO COLLECTIVE
P.O. BOX
NEW BRUNSWICK NJ. 08901
PHONE: (201) 846-8094 / 545-6769

NAME: _____
ADDRESS: _____

MAY SHOW WILL SHOW SORRY

PLEASE READ ME

AN OPEN LETTER FROM THE PRODUCERS OF "ARE YOU THERE?"

WINTER 1972 511 BEACH DR., N. CAPE MAY, N.J. 886-9369



ANY OF YOU KNOW SOMETHING ABOUT US NOW. YOU MAY HAVE SEEN US ON "ARE YOU THERE?" YOUR FIRST LOCAL CABLE TELEVISION PROGRAM, ATTENDED OUR VIDEOTAPE WORKSHOP AT MAC, SEEN US IN THE PROCESS OF MAKING A VIDEOTAPE, OR SEEN US SHOWING TAPES IN THE STREETS OR AT A LOCAL EVENT. OTHERS MAY HAVE ONLY HEARD RUMBLINGS OF OUR EXISTENCE IN THE SCHOOLS, LIBRARIES, LOCAL ORGANIZATIONS, OR THE GOOD OLD GRAPEVINE. MOST OF YOU HAVE READ ABOUT US IN THE LOCAL NEWSPAPERS. THIS IS AN OPEN LETTER TO THE PEOPLE OF CAPE MAY COUNTY ABOUT WHO WE ARE, WHERE WE CAME FROM, WHAT WE'VE BEEN DOING, WHAT MEMBERS OF YOUR COMMUNITY HAVE BEEN DOING IN CONNECTION WITH US AND WHAT WE'RE PLANNING TO DO IN THE FUTURE.

Glad to meet you -

Carole and Maxi



WHAT WE'VE BEEN DOING

WE HAVE BEEN TRYING TO INTRODUCE THE CONCEPT OF MAKING PROGRAMS ON 1/2"

VIDEOTAPE FOR NON-COMMERCIAL CABLE TELEVISION WHICH IS "BY THE PEOPLE AND FOR THE PEOPLE" OF THIS COUNTY. WE HAVE ACTIVELY SHOWN MANY OF YOU NOT ONLY HOW YOU CAN INTEGRATE THIS MEANS OF COMMUNICATION INTO YOUR OWN DAILY LIFE, BUT HOW YOU CAN ALSO HELP BRING ABOUT CHANGE AND BETTER UNDERSTANDING BETWEEN US ALL. WE HAVE ACCUMULATED A LIBRARY OF ABOUT 75 TAPES WHICH SERVE AS EXAMPLES OF HOW, WHY AND WHERE 1/2" VIDEOTAPE CAN BE USED. LOCAL GOVERNMENT OFFICIALS, INDIVIDUAL CITIZENS, ORGANIZATIONS, TEACHERS, LIBRARIANS, CONSERVATIONISTS, ECOLOGISTS, SCIENTISTS, AND ARTISTS, BOTH THE YOUNG AND OLD OF CAPE MAY COUNTY HAVE ALREADY UTILIZED THIS FACILITY. WE HAVE OFFERED A VIDEO WORKSHOP AT THE MID-ATLANTIC CENTER FOR THE ARTS, ON THE USAGE OF EQUIPMENT (HARDWARE) AND THE UNDERSTANDING OF PROCESS AND CONCEPTS OF 1/2" VIDEOTAPE (SOFTWARE). BECAUSE RECEPTION AND FEEDBACK HAVE BEEN SO GREAT, THIS CLASS WILL CONTINUE AND TWO MORE WORKSHOPS HAVE BEEN SCHEDULED TO BEGIN MID-JANUARY. WE HAVE DEVOTED MUCH OF OUR EFFORT TO EXPOSING AND CULTIVATING CABLE TELEVISION (CHANNELS 2 AND 10) AS AN OUTLET AND RESOURCE FOR LOCALLY ORIGINATING TV PROGRAMMING. "ARE YOU THERE?" IS THE PRODUCT OF THIS EFFORT AND SEEMS TO BE WORKING AS A CATALYST FOR OTHER SERIES OF PROGRAMS WHICH WILL BEGIN IN THE NEAR FUTURE.



WHAT'S HAPPENING NOW

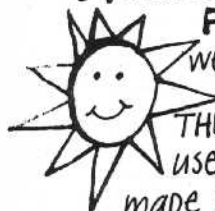

FOR THOSE OF YOU WHO WOULD LIKE TO EXPLORE THIS NEW MEANS OF COMMUNICATION, 1/2" VIDEOTAPE, WE ARE STARTING A 5 WEEK SESSION AT THE WILDWOOD HIGH SCHOOL ON JAN. 20, THURSDAY AT 7:30 PM. THIS WORKSHOP IS OPEN TO ANYONE; NO PRIOR TRAINING IS NECESSARY, JUST A BIT OF GOOD ^{OLE} ENTHUSIASM. THIS INFORMAL CLASS WILL COVER 3 AREAS: (1) VIDEO EQUIPMENT AND HOW IT WORKS (2) VARIOUS USES OF 1/2" VIDEO AND PHILOSOPHIES BEHIND THEM (3) HUMAN FEEDBACK AND CRITIQUES OF ALL TAPES MADE BY MEMBERS OF CLASS. VIDEOTAPES MADE BY WORKSHOP MEMBERS MAY BE Aired OVER CABLE TV. FOR INFORMATION CALL ARTHUR MOTZ, ADULT EDUCATION-522-6955, OR 45.

Video Directory

The following directory lists people working in alternate television, where they are working, what kind of work they are doing, and what type of equipment they have or have access to.

Undoubtedly, many people have been left out. But this is the most comprehensive list yet assembled. It combines the *Video Exchange Directory* prepared by Intermedia* in Vancouver, B.C.; a listing compiled by Johnny Videotape in Santa Cruz, California; a questionnaire distributed in *Radical Software* to many people doing video in New York State (the mailing was sponsored by the New York State Council on the Arts); a general processing of the mail that we receive at *Radical Software*; and personal contacts.

If you have been left off this list and wish to be included, or if your listing is incorrect or needs additions, then please return the form below to us.

*Michael Goldberg of the *Video Exchange Directory* has asked us to point out that our list is primarily one-way (access), while Intermedia's was designed for a two-way (communication), a process they plan to continue. Thus, in addition to feeding back to *Radical Software* (c/o Box 543, Cooper Station, New York, New York 10003) it would be helpful if you also returned a xerox of the form to *VideoExchangeDirectory* (c/o IMAGE BANK, 4454 West 2d, Vancouver 8, British Columbia, Canada).

PLEASE PRINT - EN LETTRES MOULEES, S.V.P.	
Name Nom	
Address Adresse	
	AREA CODE Tél. ()
Equipment at your disposal Equipement à votre disposition <div style="border-bottom: 1px solid black; height: 20px; margin-bottom: 5px;"></div> <div style="border-bottom: 1px solid black; height: 20px; margin-bottom: 5px;"></div> <div style="border-bottom: 1px solid black; height: 20px; margin-bottom: 5px;"></div> <div style="border-bottom: 1px solid black; height: 20px; margin-bottom: 5px;"></div> <div style="border-bottom: 1px solid black; height: 20px; margin-bottom: 5px;"></div> <div style="border-bottom: 1px solid black; height: 20px; margin-bottom: 5px;"></div>	VTR use/interest Usage/intérêt vidéo <div style="border-bottom: 1px solid black; height: 20px; margin-bottom: 5px;"></div> <div style="border-bottom: 1px solid black; height: 20px; margin-bottom: 5px;"></div> <div style="border-bottom: 1px solid black; height: 20px; margin-bottom: 5px;"></div> <div style="border-bottom: 1px solid black; height: 20px; margin-bottom: 5px;"></div> <div style="border-bottom: 1px solid black; height: 20px; margin-bottom: 5px;"></div>
<div style="border-bottom: 1px solid black; height: 20px; margin-bottom: 5px;"></div> <div style="border-bottom: 1px solid black; height: 20px; margin-bottom: 5px;"></div>	<div style="border-bottom: 1px solid black; height: 20px; margin-bottom: 5px;"></div> <div style="border-bottom: 1px solid black; height: 20px; margin-bottom: 5px;"></div>
	<div style="display: flex; justify-content: space-around; border-top: 1px solid black;"> CORRECTION OF LISTING ADD MY LISTING </div>

XEROX HERE AND MAIL TO: **Radical Software**, Post Office Box 543, Cooper Station, New York, N.Y. 10003

ALASKA

Daniel A. Howard
General Delivery
Ester, Alaska 99725

Has access to VTR equipment in conjunction with AV department at the University in College, Alaska. Doing a lot of work with social welfare agencies. Worked with prisoners inside the state jail. Presently working with Head Start pre-schoolers.

CALIFORNIA

Ann Halprin Dancers Workshop
Connie Beeson
99 West Shore Rd.
Belvedere, Cal.
435-3002

Have been using new generation 1/2" equipment . . . Some of the things they've been doing are dance tapes in Soledad Prison, pre-opening of the new Berkeley museum, body analysis and movement, and the celebration of the Sabbath in Temple.

Ant Farm
994 Union St.
San Francisco, Cal.
771-2368

A group of designers experimenting with new environmental forms. A lot of the tape they make has to do with the design forms they develop. Have done a lot of truckin' around the country in their media bus providing assistance in areas of electronic and plastic media and self-generating learning environments. Send us a tape and we'll send one back . . . no shit!

Art That Hurts
218 So. Salinas
Santa Barbara, Cal. 93103

Have small amount of 1/2" equipment and have access to more through the University of California. Video continues to be used in the usual unimaginative way by sports dept., drama, small mad usage holds some hope. We are instituting a "class" which will generate information and get us into the TV studio.

John J. Barton
2368 Torrence Blvd.
Torrence, Cal. 90501

Turned onto video through "Guerrilla Television". Bought the Akai portable unit. The unit was selling for \$300 below the list price at Montgomery Wards and besides they threw in an RF adaptor free.

Big Basin Ranch Art Institute
Susan Wilkinson
21200 Big Basin Way
Boulder Creek, Cal. 95006

Will be opening a graphics workshop summer '72 and plan to offer video graphics experience. A group of them are in the process of building a small video camera. Contact them if you're in the area.

Peter J. de Blanc
Box 926
San Rafael
Calif. 94902
(415) 453-5395

Has access to a tremendous amount of video equipment, 1/2", 1" and 2". He has complete facilities for cross dubbing all types of video tape.

Branchwater
2821 Hillegass Ave.
Berkeley, Calif. 94705

A therapeutic video collective using 1/2" video equipment. Having had training in various therapeutic methods they're putting them to use with video tape. In the sense that video is real and inherently spontaneous and pro-feedback, we're all involved in therapeutic video. Contact them for more specific information.

Sandy Jan Bruek
Palo Colorado Rd
Monterey, Cal.
(408) 624-4743

California Institute of the Arts
31700 McBean Parkway
Valencia, Calif.

Cal Arts is an institution with a tremendous amount of video hardware, half-inch and one-inch and excellent resources. There are a lot of people there that in some way are working with the 1/2" medium. For further information contact Will Bogart or Daniel M. Sullivan.

Monte Cazazza
5422 Shfater Ave. Apt. #22
Oakland, Cal. 94618

Don't know what he's into but has access to some equipment through Lanly, a local college. If you're in the area, contact him.

Irwin H. Dermen
2750 San Hill Rd.
Menlo Park, Cal. 94025
(415) 854-5222

Has access to the Bell and Howell video recorder through Internal Company Communication.

Arnold Duke
9140 Los Gatos Hwy
Santa Cruz, Cal. 95060
(408) 353-2054

Using Sony 1/2" and Ampex 1" video equipment. Involved in educational industrial training indoctrination.

Entropy
Mike Young
1914 Polk #205
San Francisco, Cal. 94109
441-4404

Environmental Communications
Venice Filmfricas
62 Windward Ave
Venice, Cal 90291
(213) 392-5071
396-1395

They're using Sony equipment and have access to Shibaden and specially modified odetics time-lapse video equipment. They're into making and distributing multi-media and slide shows to colleges.

Gordon Gietzen
San Francisco
California
(415) 989-1173

Leni Goldberg
8535 Appian Way
Hollywood, Cal. 90046
(213) 654-1600

Using Sony 1/2" equipment (both CV & AV). Documentary of life in Hollywood and the local feel with in-depth image studies.

John Hanson
4639 Irving St.
San Francisco, Cal. 94122
(415) 661-6505 or
(415) 332-9326

Dan Heeb
P.O. Box 6150
Stanford, Cal 94305
(415) 321-5166

James Hirsch
3118 Santelle Blvd. #2
Los Angeles, Cal. 90066
(213) 398-8184

Innovation
119 East de La Guerra
Santa Barbara, Cal. 93101
(805) 965-5015

This is a group that gives video lab workshop sessions. Work with all sorts of 1/2" equipment.

Henry Jacobs
Box 303
Sausalito, Cal.
(415) 383-0479

Has access to Sony 1/2" and 1" equipment besides 1" Ampex equipment. Through the ELR lab at Childrens Hospital in San Francisco.

Johnny Videotape
See: Santa Cruz Community
Service Television

Peter Wm. Kirby
25152 Everett
Newhall, Calif. 91321

Has access to 1/2" Concord studio, Sony color equipment as well as Sony 1" color studio. Children using video, color structural tapes, dance/video interplay.



John Lindt
Box 729
Cutler, Cal. 93615
(209) 732-4195

Mafundi Institute
1827 E. 103rd St.
Los Angeles, Cal. 90002
(213) 564-4496

Running a community video project called the Watts Community Communication Bureau. The program is attempting to train people in the use of video hardware, create community-related programming and get the CATV franchise for the S.L.A. area.

Richard Markell
P.O. Box 4019
Berkeley, Cal. 94704
(415) 843-1284

Media Access Center
c/o Portola Institute
1115 Merrill St.
Menlo Park, Cal. 94025

A video group that has been working out of the Portola Institute (home of the Whole Earth Catalogue). This group has an expertise in many facets of the half-inch video medium. Have done a lot of work with setting up high school video programs.

Mirror Productions
565 Manzanita
Felton, Calif. 95018

Working with 1/2" video and making pieces about old people, rhythm bands and blue grass locals.

John G. Moore
135 N. Fern Ave.
Ontario, Cal. 91762

Odetics, Inc.
Project Earth
Rick Bluhm
1845 So. Manchester
Anaheim, Calif. 92802
(714) 530-6050

A company which has developed a time-lapse video camera. Through them a group called Project Earth has formed. Have access to dozens of portapaks which they are using for various projects in the So. California area. Contact for more information.

Optic Nerve
Jules & Bill
Project One
San Francisco, Cal.
861-4385

Richard Felton Outcault IV
Box 457
Stevenson College
U.S. Santa Cruz
California 95060
(408) 429-4374

Pacific Domes
Lloyd & Sarah Kahn
P.O. Box 279
Bolinas, Cal 94924
(415) 868-0280

They're using Sony 1/2" equipment and are into taping a lot of dome stuff.

Edward Pacio
715 21st Ave.
San Francisco, Cal. 94121
(415) 752-1235

Part of a group called Dove Productions using Sony 1/2" equipment. To expand the consciousness of man through the moving visual medium, rather than using it as a central nervous system for the country.

Pleiades Communication
Richard C. Taiber
808 Cheltenham Rd.
Santa Barbara, Cal.
(805) 966-9894

Have access to Sony 1/2" equipment through the AV Dept. at the University of Calif. at Santa Barbara. They're into experimenting with video, light projection and holography.

Quantam Communications, Inc.

Joan McKenna
2330 McKinley
Berkeley, Cal. 94703
(415) 548-4000

They own 2 Sony portapaks, and have access to 1" equipment. Get in touch with them for more information.

Resolution
Jay and Tia Odell
818 Hayes

San Francisco, Cal. 94117

Have Sony 1/2" equipment. Interested in the possibilities of alternate distribution in the community, colleges, cable, etc. Spent a year taping in Central America and are putting together a piece on the Guatemalan Indians.

Roberta Rich
19537 Minnehaha St.
Northridge, Cal. 91324
360-5651

Jeremy Samuels
520 Wilkes Circle
Santa Cruz, Cal. 95060
(408) 423-7488

Santa Cruz Community Service Television
H. Allan Frederickson (Johnny Videotape)
695 30th Ave. #E
Santa Cruz, Cal. 95060

These people are very much into using half-inch video equipment for intra-community communication with emphasis on approaches to liberating CATV for the people. A book will be published soon titled Community Access Video which will deal directly with the above.

Robert Sherman
958 N. Palm #113
Los Angeles, Cal. 90069
(213) 657-4437

Wally Thurston
Box 7984
Stanford, Cal.
941-4416

University of California at Los Angeles
Mitsuru Katasha/asst. Professor
Dickson Art Center
Los Angeles, Cal. 90024

Have over \$30,000.00 worth of equipment on loan from Concord Electronics to carry out video experiments based on the idea that multiple disciplines be invited to participate in exploration. They are using both half-inch and one-inch equipment.

Video Free America
Arthur Ginsberg
1948 Fell St.
San Francisco, Cal. 95018
(415) 362-0151

Have a lot of hardware to work with, (half-inch) including a sophisticated matrix (switcher) for multi-monitor presentations. They've done a lot of experiments with 1/2" video. Operate an ongoing theatre and production facility. Last summer presented a one-month video show in conjunction with the Berkeley Museum showing tapes from all over the country. They are working on a continuing videotape called "The Adventures of Carol & Ferd."

Video Studios, Inc.
Bob Jordon/Marty Veselich
10421 Scenario Lane
Los Angeles, Cal. 90024

Have a lot of experience in the transfer of tape to film. Contact them for more information.

Vidiots
Fred Endsley
Dickson Art Center
U.C.L.A.
Los Angeles, Cal. 90024
(213) 463-7498

Have access to Sony and Concord video equipment. Involved in Pure Design Shows, video training and educational tape making.

Willie Walker
2151 Encinal Ave.
Alameda, Cal.
521-7436

Janice Zimmerman
5812 Costello Ave
Van Nuys, Cal. 91401
(213) 873-4878

Has access to both Concord, Sony 1/2" equipment, particularly interested in using video for community action programming, also participatory television.

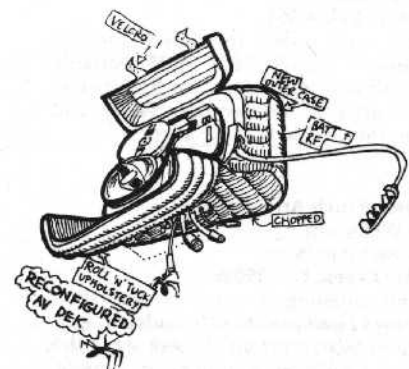

COLORADO

Grass-Roots Network

Eleanor Bingham
Box 2006
Aspen, Colorado

A freak video group working with 1/2" Sony portapak, Super 8 and 16mm film over an open channel on Cable TV.

Michael Handler

2060 West Iliff
Englewood, Colo. 80110
(304) 934-9256

Radical Information Project

737 E. 17th. Ave.
Denver, Colo. 80203
825-7413

University of Colorado

Kelly Radcliff/John Craig
710 A 30th. St.
Boulder, Colo. 80302
449-6928

They indicate that the university has Sony 1/2" equipment. Not sure what they're into.

CONNECTICUT

Philip Bowles

3100 Yale Station
New Haven, Conn.
(203) 432-3100

Has access to Yale University equipment. Sony 1/2", 1" and 2" is available. Indicates that many people in the art and architecture depts. using portable video equipment.

Mitchell Kapor

2983 Yale St.
New Haven, Conn. 06520
(203) 432-2983

University of Bridgeport

Dr. Howard B. Jacobson
Journalism Dept.
Bridgeport, Conn. 06602
(203) 384-0711

Sony, AV Dept. of school has Sony & GE 1/2" equipment. Also Ampex 1" equipment, but keeps tight control on the usage it gets. Interested in getting free access for student use.

FLORIDA

Blair McCann

Underground Vegetables
Box 434
Coral Gables, Fla.
(305) 448-2697

(in New York):

72 East 93rd St.
New York City 10028
877-0980

Elliott Mitchell
631 East Livingston
Orlando, Fla. 32803
(305) 422-1127

Stephen Westling

101 Elm St.
Pensacola, Fla. 32506
(904) 455-1487

Has access to 1" IVC equipment, through the local CATV.

ILLINOIS

Art Institute of Chicago

Philip Lee Morton
1839 So. Halsted St.
Chicago, Ill. 60608
(312) 666-5628

I teach an experimental video/video-tape operation at the Art Institute. Use 1/2" Shibaden equipment.

Paul Appel

1720 Kirk St.
Evanston, Ill.

Billboard

Earl Paige
150 N. Wacker Dr.
Chicago, Ill. 60606
(312) 236-9818

Bruce Collen

Lakewood Park—Trailer 1 RFD #3
Carbondale, Ill. 62901
(618) 549-7196

Has access to Shibaden and Sony 1/2" equipment as well as Ampex 1" equipment.

Richard Green

1006 W. Main St.
Urbana, Ill. 61801
(217) 328-1611

Has access to Sony 1/2" equipment.

Stephen Haliczzer

Northern Illinois University
Dept. of History
Dekalb, Ill 60115

Don't know what type of equipment he's using, but has produced educational video tapes through the History Department.

Paul Hinaber

211 W. Green
Urbana, Ill 61801
(217) 344-1546

Laboratory on Video Excellence

8601 Kilbourn
Chicago, Ill 60652

Have Sony 1/2" equipment. Sony dealership, forming a hardware co-op and developing software on Type 1 standard. Also have complete design capability for wireless TV cameras and low light level cameras and 3-D.

Janet Paitl
3627 So. Ridgeland
Berwyn, Ill. 60402
788-1828

Stuart Pettigrew

Video Department
School of the Art
Institute of Chicago
Michigan Ave. & Adams St.
Chicago, Ill.

Robert Sandidge

1245 Fairwood Ct. #5
Elgin, Ill. 60120
695-8337

Has access to Concord and Panasonic 1/2" equipment through Elgin State Hospital.

Robert B. Shapiro

3542 N. Kimball Ave.
Chicago, Ill. 60618
(312) 267-9200

Has access to Sony 1/2" equipment.

Bob Shellenberger

Dept. of Philosophy
Knox College
Galesburg, Ill. 61401

St. Mary Center for Learning

Sr. Ann Christine Heintz
7064 N. Damen
Chicago, Ill 60645
(312) 973-1257

Working with an experimental high school and using Sony 1/2" and IVC 1" equipment. Making tapes about school reform in high schools.

Tedwilliam Theodore

712 W. Waveland
Chicago, Ill. 60613
(312) 528-8618

Using 1/2" Panasonic (type one standard) and 1" Panasonic and Ampex equipment to facilitate community organization and social action, cable and tape as tool of non-profit, social action agency.

Video Free Chicago

8601 So. Kilbourn
Chicago, Ill 60652

Are you for real? People not intimidated by the above and wanting to evolve in a climate of life as art utilizing videotape as a means of expression. Contact: Dave.

T.H. Ware

3 Woodley Rd.
Winnetka, Ill. 60093

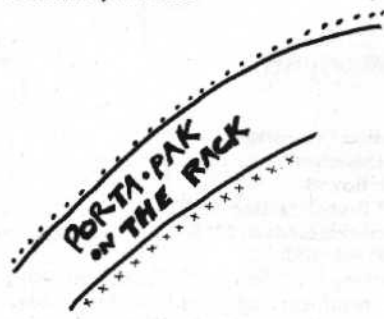

IOWA

Howard J. Ehrlich
1157 E. Court St.

Iowa City, Iowa 52240

Has access to Shibaden 1/2" and Ampex 1" equipment through his University.

KENTUCKY

University of Kentucky
College of Architecture
Pence Hall

Lexington, Ky. 40506

A group of people have access to and are working with Sony 1/2" equipment. Seems like they're into it. Contact Stewart Robertson or Louis Deluca.

Univ of Ky.

College of Architecture

Louis de Luca

Lexington, Ky. 40506

(606) 257-1647

University of Louisville

David Miller

932 Cherokee Rd.

Louisville, Ky. 40204

(203) 459-3858

Has access to Sony and Shibaden 1/2" video equipment through the University.

MARYLAND

Antioch College

Baltimore Campus

805 N. Charles St.

Baltimore, Md. 21202

(301) 752-3656

This institution may become the first video college. Primarily involved in social change methods—most of its programs have a video element. They have a good supply of Sony 1/2" video equipment and are experimenting with many facets of the "video experience". For more information, contact Alan Kaplan or Tom Johnson.

Antioch College

Columbia Campus

Paul Schatzkin

Wild Lake Village Center

Columbia, Md. 21243

(301) 730-5469

Working with half-inch Sony equipment. They are exploring production possibilities for the CATV in Columbia.

MASSACHUSETTS

Audion Enterprises

W. Desmond

P.O. Box 93

MIT Branch Station

Cambridge, Mass. 02139

(617) 868-9788

Working with Sony 1/2" equipment. They are producers of Broadside/Free Video Press . . . a quarterly 15-minute video taped magazine.

Boston College

Newton, Mass.

They have Sony 1/2" and 1" equipment. For further information, contact Timothy D. McInerney, 62 Chestnut Hill Rd., Newton, Mass. 02167 (617) 232-3300

Becker Video Productions

Nicholas R. Cowenhoven

61 Sever St.

Worcester, Mass. 01609

(617) 791-9241, ext. 49

Have access to video equipment at Becker Junior College. They have a good supply of half-inch and one-inch equipment which they get from other institutions. They have contacts with other groups using video equipment in Worcester.

Commander Video USA

The American Universal Corp.

11 Beach Street, P.O. Box 401

Manchester, Mass. 01944

Earth Light

354 Broadway

Cambridge, Mass.

(617) 876-7807

A group originally with Comm-University. They are learning to fix equipment and willing to share the knowledge. Work with community groups on video to produce tapes and learn about cable.

Ghost Dance, Inc.

36 Bigelow St.

Cambridge, Mass. 02139

(617) 661-1012

Have Sony 1/2" portapak and access to complete 1" and 2" studios. Work is largely concerned with what have been called "Special Effects", also with video image synthesis, computergraphics and the creation of meaningful abstract electronic patterns. Design information systems, have deep interest in 2-way CATV. Ghost Dance is developing tools and techniques to probe TV's impact on the brain. We build video environments.

Michael Hall

Lawrence Academy

Groton, Mass. 01450

448-6418

Using Sony 1/2" equipment through Lawrence Academy.

John Le Baron

P.O. Box 142

So. Deerfield, Mass. 01373

(413) 665-3687

Has access to Sony 1/2" and 1" equipment through the Media Center, School of Education, University of Mass. at Amherst.

Headwind

Box 2

Warwick, Mass. 01378

(617) 544-3732

Have small amount of Sony 1/2" equipment. One of their members has attended Sony Video School to learn how to maintain the equipment and is willing to share the knowledge. Interested in tape exchange of any kind.

Red Tape

Terri & Mike

15 Elm St.

Somerville, Mass.

(617) 776-5814

Work with community people making tapes, teaching and talking about cable.

Emerson College Library

303 Berkeley St.

Boston, Mass. 02116

They have Shibaden 1/2" equipment and an RCA two-inch machine.

Seymour Epstein

16 Moore St.

Somerville, Mass. 02144

Working in contemporary Jewish studies at Brandeis University running a media lab for Jewish education. Work with 1/2" Sony equipment.

Jim Frantzreb

144 Amory St. #1

Brookline, Mass. 02146

(617) 731-9845

Has access to half-inch Sony equipment through the School of Public Communications at Boston University.

F.U.N.E.

Jim McDonnell

41 Calumet St.

Roxbury Crossing, Mass.

(617) 277-8768

We like to go places where people want to develop access to hardware and help develop access. Teach people how to use equipment and show tapes. We like to do urban tapes and concentrate mostly in Boston.

Anthony W. Hodgkinson

142 Mystic Valley Parkway

Arlington, Mass. 02174

(617) 643-3956

Gerd Stern Intermedia

711 Mass Ave

Cambridge, Mass. 02139

(617) 868-9880

J.R. Getsinger

111 Walter Hastings Hall

Cambridge, Mass. 02138

(617) 498-4772

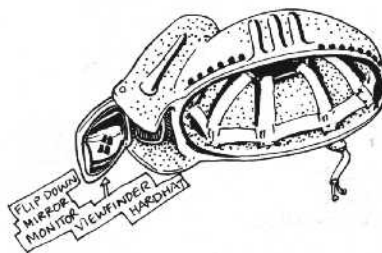

Fred Portnoy
Stockbridge, Mass. 02162
(413) 298-3255

Peter Simmons
24 Mt. Auburn St.
Cambridge, Mass. 02138
(617) 876-0904

Doesn't have own equipment but says there's Sony 1/2" equipment in Department of Child Studies at Tufts University and Wellesley College. Contact him for more information.

Fred Taubman
Box 642
Hampshire College
Amherst, Mass.
(413) 542-5225

Has access to Sony 1/2" and 1" equipment as well as a studio access through Hampshire College.

Urban Planning Aid-Media Video Project
Jodie Orben
Media Project—UPA
639 Mass. Ave.
Cambridge, Mass.

They like to talk to city folk about cable TV, to help cable become a people's tool. They are into making urban tapes with community people teaching how to use hardware.

Craig Unger
Harvard Crimson
14 Plimpton St.
Cambridge, Mass.
(617) 547-2811 (off)
(617) 547-5457 (home)

MICHIGAN

Central Michigan University
Cinematic, Art Dept.
Robert N. Mannic
Mt. Pleasant, Mich. 48858
(507) 774-3512

They have Sony and Concord 1/2" equipment and Sony 1" equipment.

Mark Lloyd, Lydia Kleiner
325 E. Jefferson
Ann Arbor, Mich. 45104
(313) 663-9875
Have use of Sony 1/2" equipment.

Michigan State University
Center for Urban Affairs
Jason P. Lovette
E. Lansing, Mich. 48823
(517) 353-9320

Using Sony 1/2" equipment and have access to Sony, Ampex and Shibaden 1" equipment.

Mt. Pleasant Media Group
Bill Tregea/pat Mullory
1028 So. Arnold
Mt. Pleasant, Mich.
(507) 773-7478
They're using Sony 1/2" equipment.

United Auto Workers
John Hunt
Family Education Center
Black Lake
Onaway, Mich. 49765
Currently teaching a workshop on the use of VTR for local unions. Using Sony 1/2" equipment.

Western Michigan University
Div. of Instructional Communications
Fritz Seegers
Kalamazoo, Mich. 49001
(616) 383-1869

Using Ampex 2" high and low band and Kinescoping them. Interested in getting into 1/2" taping.

MINNESOTA

Thomas Bender
1940 Sheridan Ave.
So. Minneapolis, Minn.
(612) 374-1847

Has access to Sony 1/2" video equipment through local university.

Scott Helmes
606 8th St.
S.E. Minneapolis, Minn.
(612) 331-1211

Has access to Sony 1/2" video equipment as well as 2" decks. Working out tape exchange with universities.

Kailasa
Jon Shafer
1510 E. 23rd St.
Minneapolis, Minn. 55404

Have introduced portable 1/2" equipment to free schools, a pre-school, and university programs as well as helping community groups (religious consortium, a street academy, model city project) to utilize 1/2" video.

MISSOURI

KDNA Radio
4285 Olive St.
St. Louis, Mo. 63008
OL-2260

They don't have equipment themselves but say that the Psych. Dept. at St. Louis University has 1/2" Sony video equipment as well as at Merrimac Community College. Contact for more information. KDNA Radio isn't unlike WBAI except we are a much more loosely knit community (within the station, that is).

Oscar Acetate & Video Queen
6267 Delmar Blvd
University City, Mo. 63130

My experience with video has been to use closed-circuit units in environments contrasting, comparing, and juxtaposing it to basic elements, such as water. Just received a grant and are purchasing Sony 1/2" equipment.

Webster College
Student Video Theatre
Tom Lang/Rush McAllister
St. Louis, Mo. 63119
(314) 968-0500 ext. 240/283
Have Sony 1/2" equipment.

NEBRASKA

Creighton University
Eric Somers
Omaha, Nebraska 68131
(402) 536-2817 (office)
(402) 348-1560 (home)
Somers is an instructor in communications at University. CCTV system, gives summer workshop in experimental video.

Concordia Teachers College
Jack L. Middendorf
Seward, Nebraska 68434

Audio visual center use in college campuses, high schools, campus elementary lab school. Using Sony 1/2" and Ampex 1" equipment. Involved in drama, music, creative arts and documentaries.

NEW JERSEY

Lawrence Budner
140 Genevieve Ave.
Hawthorne, N.J. 07506
(201) 423-0742

Has access to Sony and Shibaden 1/2" equipment as well as Ampex and IVC 1" equipment. Says that Media Center at Dowling College on Long Island, and Paterson State College's Speech Dept in New Jersey have portable video equipment.

Daycare, Inc.
49 S. Munn Ave
E. Orange, N.J.
Alan Furst
(201) 672-0333
Private community mental health center using Panasonic equipment.

Richard Lipach
Deepdale Dr. Rd #3
Dover, N.J. 07801
(201) 895-2906 -or-
895-2927
Has access to lots of Sony CV and AV equipment. Is interested in working with others on VT projects (he must operate equipment).

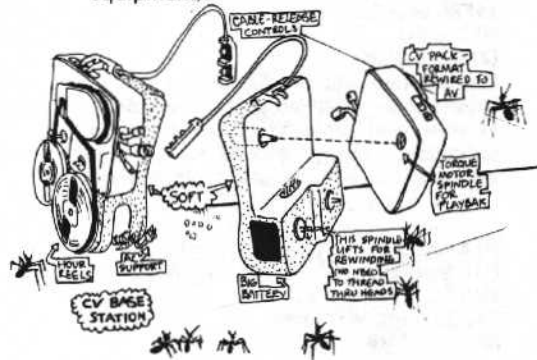

James Randi
51 Lennox Ave
Rumson, N.J. 07760
(201) 747-1168

Using Sony CV equipment. Taping rehearsal performances, observing techniques of my trade: prestidigitator.

Robert Spindel
145 Prospect St.
Leonia, N.J. 07605
(201) 947-4569

Leonard Van Arsdale
316 E. Allendale Ave.
Allendale, N.J. 07401
(201) 327-4088
Experimenting in schools, specialization artistic children.

NEW MEXICO

Ray Hemenez
517 Hillside Ave.
Santa Fe, N.M. 87501

NEW YORK

Acme Video Rangers
Andy & Fred Mann
108 Thompson St.
NYC
(212) 925-7482
Gotham City's A-1 cameramen. Use Sony AV 1/2"

Jim Portanova
Arts Editor
Adelphia University
59-11 159 St.
Flushing, New York 11365
(212) 358-5604

Alternative Environmental Futures
Douglas White
316 W. 88th St.
New York City
(212) 724-7466
Have 1/2" production unit consisting of Sony portapaks and editing equipment. Programming related to the alternative culture.

Alternate Media Project
George Stoney/Red Burns
144 Bleeker St.
NYC 10003
(212) 873-8640
Has planned and produced "events" to show people what can and is being done in video and cable. They travel, have a radio tape exchange with 400 hrs. of tapes and act as a clearinghouse for information.

Jack Amon
P.O. Box 22
SUNY
Binghamton, N.Y. 13902
(607) 798-3418

Steve Arker
SUNY
45 Linden Ave.
Brooklyn, N.Y. 11226
IN 2-1686

Ann Arlen
1261 Madison Ave
New York City 10028
(212) LE 4-0584
Has Sony 1/2" equipment. Using for documentation of real people, real events, ranging from music through demonstrations.

Karen and George Back
333 East 75th St.
New York City 10021
628-5275

Balensi
Mick Cribben
450 E. 63rd East Bldg. 3B
New York City
(212) MU 8-3890
Has access to 1/2" Sony equipment through Columbia University.

Peter Barnosky
258 71 St.
Brooklyn, N.Y. 11209
SH 5-7980

Chelsea Theatre Center
c/o Michael David
The Brooklyn Academy of Music
30 Lafayette Ave.
Brooklyn, N.Y. 11217
(212) 783-5110
Have 2 Sony 1/2" studio decks and cameras which are used full time for rehearsal monitoring and performance recording.

Shirley Clarke
Hotel Chelsea
222 West 23rd St.
New York City
(212) CH 3-3700
Has first Sony 1/2" camera where viewfinder is not attached to the camera, and where the vidicon & lens are attached to your wrist.

The Dance Foundation
Spurr St.
New Berlin, N.Y. 13411
Using 1/2" equipment (don't know what kind) for taping dance programs.

Douglas Davis
27 Washington Sq. N.
New York City 10011
(212) 533-3618
Uses Sony 1/2" equipment contributed to Video Variations, PBS Network, WGBH-TV Boston. Personal 1/2" tapes shown at U. of Cal. Berkeley. Participate in TV concert in NYC early 1972.

Dimitri Devyatkin
195 Nagle Ave
New York City 10034
(212) LO 9-7167
Has use of Sony 1/2" equipment. More interested in abstract work than pure documentation.

East Store
Don E. Lewis
335 East 9th St.
New York City 10003

Electron Fields
Rick Sternberg
Seaview Lane
Center Moriches
Long Island, N.Y. 11934
(516) 878-4482
Using 1/2" portable equipment. Trying to organize a video project in Southeastern Suffolk. Have a lot of tape on local happenings.

Thomas A. Garrison
315 East 86th St.
#9 TE
New York City
289-9368

Mitch Gerber
530 W. 112th St.
Apt. 52
New York City 10025
662-1760

Global Village
Rudi Stern/John Reilly
454 Broome St.
New York City 10012
(212) 966-1515
Have Sony 1/2" equipment. Involved in community work. Theatre presentations. Environments, consultation.

Nicholas Goldsmith
350-C Mary Donlon
Cornell University
Ithaca, N.Y. 14850
(607) 256-1634
Has Sony 1/2" CV series and can borrow AV series. Interested in underground uses of video feedback and the different methods involved.

Ernest Gusella
98 Bowery—4th Fl.
New York City 10013
966-6089

Robin G. Halwas
Colgate University
POD 2067-85
Hamilton, N.Y. 13346
(315) 824-9726
Has access to Sony 1/2" equipment through the university.

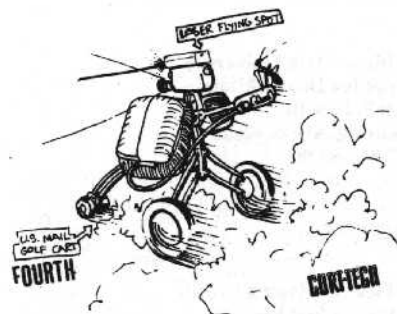

Columbia, Greene Comm. College
AV & English Dept.
Greta Kimball
Athen, N.Y. 12015
954-1850

Don't have equipment yet. A small college that is just starting out but could use all information it can get about video. Wants to make purchase.

Harpur College
(Sunny Binghamton)
Jack Amon/Ken Domonick
P.O. Box 22
Binghamton, N.Y. 13902
(607) 798-3418

Have Sony 1/2" equipment. Setting up a 1/2" video tape station at Harpur college. Interested in a tape exchange.

Erik Haskell
Box 442
Ocean Beach, N.Y. 11770

Has CV Sony 1/2" series. Make experimental tapes.

Houghton College
AV Dept.
Houghton, N.Y. 14744

Have Sony 1/2" studio and portable equipment. Used primarily in teacher training.

Hunter College
Mrs. Paula Kurman
695 Park Avenue
N.Y., N.Y.

(212) 360-2893

Don't know what they're into, but have Sony 1/2" equipment.

Instant Replay
Patricia F. Sheffield
133 East 30th St.
New York City 10016
(212) 683-3015

Has Sony 1/2" equipment (AV & CV) as well as other video accessories. Use for off-off-Broadway plays and musicals (dress rehearsal and brush-up).

Yukihisa Isoke
33 Bond St.
New York City 10012
(212) 675-8159

Has access to Sony 1/2" CV series equipment.

Joshua Television
277 Park Ave.
New York City
(212) 826-9777

Has access to both IVC & RCA 1" and 2" equipment owned by Management Television Systems. Joshua Television is a division which does video magnification for large music events in color.

Kingston Cablevision
Mike Fisher, Program Director
Port Ewen, N.Y. 12466
(914) 331-1711

Own RCA and IVC 1" equipment as well as a small amount of Sony 1/2" equipment. We are currently producing about 4 hrs. a week of varied local programming. The vast majority of this is service programming for the community.

Leicester Commune
Vince Giuliano
104 Leicester Rd.
Kenmore, N.Y.
(716) 875-5914

Own both AV and CV Sony 1/2" equipment, and have access to Ampex 1" through SUNY for certain educational purposes.

Longwood High School
Chuck Anderson
Middle Island, N.Y.

924-6400, ext. 24

Have access to Sony 1/2" (AV) equipment as well as Ampex 1". What's happening in schools around the country? We have tapes on racial disturbances in schools, local free schools, and community attitudes towards schools.

Magus Vidicon
Louis M. Brill
155-05 71st Ave.
Flushing, N.Y. 11367
(212) 591-7699

Have access to 1/2" equipment to produce their tapes. They're a group of students of theatre and the occult. (Poets, magicians, psychics, alchemists and warlocks). Video is their common form of expression towards cosmic consciousness through the gate of the 2nd dimension.

Media Equipment Pool
Bonnie Klein
308 Park Ave.
Rochester, N.Y.
(716) 244-1259

Have good source of Sony 1/2" equipment. Both portable stuff and studio. Involved in teaching, community organizing, forums, dialogue, "raising people's media-consciousness."

Mend School for Exceptional Children
Charles E. Mizzi, Director
1481 Madison Ave
New York City 10029
(212) 348-0020

Own Sony 1/2" portable deck and camera. Use mostly in teacher training.

New Life Productions, Inc.
835 W. Onondaga St.
Syracuse, N.Y. 13204
(315) 478-6050

People's Video Theatre
544 Ave of the Americas
New York City 10011
(212) 691-3254

Have Sony 1/2" equipment. Developing community 1/2" video systems for exposing goods, services, ideas and feelings. Developing video journalism on a community level. Encouraging community to gain access to Cable TV and produce 1/2" programs.

Raindance
Post Office Box 543
Cooper Station
New York, New York 10003
(212) 687-4210

Have Sony 1/2" equipment, portables and editing facilities. Developed Radical Software... to make the world a better place.

Richard Robinson
Box 180
Planetarium Station
New York City 10024
874-3201

Leonard Sachs
533 Fernald Hall
Columbia University
New York City 10027
280-7172

Saint John Fisher College
Tom Proletti, Director
3690 East Ave.
Rochester, N.Y. 14618
(716) 586-4140

Have Sony and Craig 1/2" equipment as well as Ampex 1" equipment. Involved in environmental experiments, teaching, fun.

R. Scott Samuel
2 East 48th St.
Ogilvy & Mather
New York City
MU 8-6100

Albert Schoepflin
222E. 23rd
Chelsea Hotel—Rm 204
(212) CH 3-3700
Has Sony 1/2" equipment.

School of Visual Arts
Film School
Everett Mison, Chairman
New York City 10010
(212) OR9-7350, ext. 24

Have Sony 1/2". Available to their department. Indicate that there is much more equipment throughout the school.

Eric Siegal
c/o Howard Wise
Rm 1011
2 West 13th St.
New York City 10011
(212) 989-2316

Has Sony 1/2" equipment. Has developed Color Synthesizer. Involved in documentary, video artistic abstraction, spiritual education.

SLG Television Co.
303 West 42nd St.
New York City
(212) CI 6-5300
Have both Sony and other 1/2" equipment.



South Bronx Community Action Theatre
Barney Gelfand
345 Brook Ave.
Bronx, New York 10454
MO 5-8448

They have two closed circuit consols. Documentary taping, taping of community planning, music convention.

Space Videoarts
Frank Cavestani
344 W. 36th St.
New York City 10018
(212) 947-4671

Have available Sony 1/2" equipment. Work with new performance groups in rehearsal and documentation of techniques, productions and research. Wish to establish tape exchange.

Syracuse University
Carl Geiger
Jabberwocky
311 Waverly Ave
Syracuse, New York

Has developed its video system from one of basic production capabilities to a complete CCTV distribution and production system. Have hooked up entire school for closed-circuit programming.

Tapeview Productions, Inc.
Stewart Kaplan
34 West 36th St.
New York, New York 10018
(212) 947-5715

Have assortment of Sony 1/2" equipment which is used for production of closed circuit programs for entertainment, and commercial usage.

City University
Randy Tarrier
33 West 42nd St. #1403
New York City 10036

Has access to Sony 1/2" equipment as well as Ampex and Norelco 1" equipment.

Trafco, Inc.
Peter Francis/Bruce Mosher
475 Riverside Drive Suite #420
(212) 633-8900

Using Sony 1/2", Ampex 1" and Motorola, Ampex modified 1" equipment.

The Ultimate Mirror
308 West 82nd St.
New York City 10024
(212) BE 3-3300

Work with 1/2" video equipment. Are interested in exchanging tapes. Write them for their tape list.

Unilox Inc.
48-20 70th St.
Woodside, N.Y. 11377
(212) 651-2258

Have Panasonic 1/2" and 1" equipment besides a videostrobe 800.

Urbex Affiliates, Inc.
Larry C. Coppard
365 Rockingham St.
Rochester, N.Y. 14620
(716) 275-0535

Own and have access at local ed. inst. Sony 1/2" equipment. Using video in training community groups in how to deal with community programs.

The Vasulkas
(Woody & Steinna)
111 East 14th St.
New York City 10003
(212) 473-2054

Working with various types of 1/2" video equipment. Involved in community action, music, dance and experimental art.

VEGA
Guy Pignolet
Video Center
Uris Library
Cornell Univ.
Ithaca, N.Y. 14850

Working with both CV and AV Sony 1/2" equipment. They have gone all over the East Coast with university-loaned equipment to make recordings.

Video Access Inc.
Sandy Leeder
227 West 13th St.
New York City 10011
(212) 924-2607

Working with Sony 1/2" equipment. Want to do video exchange with high school students in N.Y. and the deep South. Predominantly concerned with video taping at the Integral Yoga Institute in New York City.

Video Coop
c/o Manhattan College
Student Govt Office
Thomas Hall
Riverdale, N.Y. 10471

Are using Panasonic 1/2" equipment. The co-op will broadcast to students, faculty and administration. Have studio.

Video Community at Westbeth
Ann Douglas/Al Katzman
463 West St.
New York City 10014
(212) 243-2201

Own and have access to Sony 1/2" equipment. An artist housing complex which through a closed-circuit cable system is programming materials gathered from local New York groups as well as material organized at Westbeth itself to all residents within the complex.

Video Exchange
David Schiller/Michael Temmer
500 La Guardia Pl.
New York City 10012

Have Panasonic 1/2" deck as well as Ampex (helical scan) 2" deck. A videotape recording unit primarily for dancers. Interested in making dance self-supporting through the rental of videotaped performances to high schools, colleges, universities, and other community outlets.

Videofreex
Maple Tree Farm
Lanesville, N.Y. 12450
(914) 688-7084

Have extensive amount of Sony 1/2" equipment as well as a 1" editing deck. Working for a long time in New York City. Moved out of the city to set up a Mobile Video Bus which would go around to various New York communities in New York State. Some of their members are currently involved in projects outside the country. A technical video manual will be put out in early Spring dealing with repair/modification procedures.

Wagner College
John Cook
Staten Island
New York 10301
390-3153

Walter Wright
66 Milton Rd.
Apt. H42
Rye, New York 10580
(914) 967-2466

OHIO

Antioch College
Bob Devine/Jac Marsh
Yellow Springs, Ohio

Have been doing extensive programming which is shown to Yellow Springs community and soon Great Lakes colleges . . . been using both studio and 1/2" equipment. Contact them for complete listings and possibilities of exchange.

Bowling Green University
Bill Gubbens
WBGU TV-70
Bowling Green, Ohio 43403
(419) 372-2676

Work at an ETV/public station in the university. Have access to Panasonic 1/2" equipment, Ampex 1" equipment and IVC 1" equipment. Interested in the formation of a company on the line of Videofreex.

Fred Harner
4 1/2 W. State
Athens, Ohio
(614) 593-6572

Stephen A. Kelbick
Box 340
3455 Murray Hill Rd.
Cleveland, Ohio 44106
(216) 795-7824

Tim Mabee
WYSO
Antioch Union
Yellow Springs, Ohio
(513) 767-7715

Robert Mueller
612 Oak St.
Dayton, Ohio 45409
(513) 223-1465

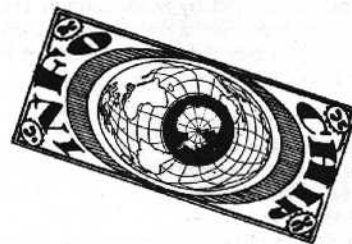

Ohio State University
Multimedia Lab
Div of Art Ed
Thomas E. Linehan
Columbus, Ohio
228-0178

Working in the multimedia lab, Division of Art Ed. Have access to Sony 1/2" equipment.

Ottawa Valley Council for Continuing Ed.

Robert Stout
1101 Cash Tower
Lima, Ohio 45801
332-3015

Using Sony 1/2" equipment mainly for teaching of various skills, procedures and concepts to medical personnel.

OKLAHOMA

LVO Cable, Inc.
c/o Grep Liptak
P.O. Box 3423
Tulsa, Okla. 74101
(918) 587-1581

Have Sony 1/2" equipment and access to Sony, Ampex & IVC 1" equipment. Run a high school video workshop. Consult on cable/community programming. Work a great deal in free education.

OREGON

Terry Conrad
2750 Charnelton
Eugene, Oregon 97405
(503) 345-6071

Has 1/2" portable equipment as well as 1" studio equipment. Instructions in research and expression, work study aesthetics and community documentation.

Jack Eyerly (E.A.T. Northwest)

1990 S.W. Mill St.
Portland, Oregon
(503) 223-7898

Has access to Sony 1/2", Ampex 1" and 2" broadcast equipment.

Bobby Steinbrecher
Emerald Enterprises Rm 414
795 Willmette St.
Eugene, Oregon 97401

Has Sony portapak, needs more tape, resources, west coast contacts.

James Taggard
430 E. 18th St.
Eugene, Oregon 97401

Has access to Sony 1/2" equipment. Used in therapy intervention in psychiatric unit of general hospital.

Wayne Waits
c/o KBOO
3129 S.E. Belmont
Portland, Oregon 97214
(503) 234-5432

Has Sony 1/2" equipment as well as Ampex and IVC use of 1" equipment. Experimentation, community use of equipment (productions), communication.

PENNSYLVANIA

Annenberg School of Communication
University of Penn.
Howard Goldblatt/Albert Rose
3620 Walnut St.
Phila., Pa. 19104
(215) 594-7053

Has complete access to IVC studio. Equipment is RCA & Ampex 2" also Sony & Craig 1/2", cameras and decks.

Carnegie-Mellon University
Ralph J. Guggenheim
5635 Hobart St.
Pittsburgh, Pa. 15217

Has access to Sony 1/2" equipment through the university.

Cyclops
Geoff Stiles, Peter Cuzzo
3701 Chestnut St.
Phila., Pa.
(215) EV 75125

Trying to set up a local community oriented video project in Philadelphia area. Want to get together with any other people with equipment.

Earth Conscious
Jim Pope
c/o 27 Lehigh Pkway N.
Allentown, Pa. 18103
(215) 434-5006

Haverford College
Eric Bodner
Box 55
Haverford, Pa. 19041
(215) MI 2-3396

We have just got a machine and we want to exchange tapes and information.

Synergy
R. Krage
755 S. 8th St.
Phila., Pa. 19147
Working with 1/2" video doing community TV, documentaries.

Thomas Jefferson University
Medical College
Ronald Muse
214 So. St.
Philadelphia, Pa. 19147
(215) 829-6662

Has access to the University's one-inch Ampex.

Video Kinetics
611 E. Passyunk Ave.
Phila. Pa. 19147
(215) PE 5-3478
Using 1/2" Sony equipment to develop programming for CCTV in Philadelphia. We ran a video theatre for 5 months employing multiple screen presentation. We are now planning a mobile TV theatre in a 20-seat school bus. May be used for political campaigning.

RHODE ISLAND

Jerry Clapsaddle
9 College Rd.
Kingston, R.I. 02881

Rhode Island School of Design
(Performance): Don Monroe
Box 5BU R.I.S.D.
2 College St.
Providence, R.I.

New inputs into a video situation. A group working with behavior and other environments effecting changes, effecting habits.

University of Rhode Island
Roder Conway
Asst. Director
Memorial Union
U. of R.I.
Kingston, R.I.

Just getting into video, newly acquired hardware is for students (most equipment on campuses not for students). They are enthused about getting into it.

TEXAS

Jim Frazier
515 Bernhard St.
Denton, Texas 76201
(817) 387-0676
Using Sony 1/2".

Gary W. Jones
3730 Fairfax
Dallas, Texas 75209
Has access to Sony 1/2" and 1" equipment through a local television production company.

Mosaic
Foto Gray Gang
1601 Pearl St.
Austin, Texas
(512) 478-9049
Four people starting a video theatre, need programs.

University of Texas
David Hollenbach
608 Blanco
Austin, Texas 78703
Has access to Sony equipment through the University.

VERMONT

Robert Chappell
Goddard College
Plainfield, Vt.
454-9311

Has Sony 1/2" portapak and editing equipment. Trucking around with my portapak taping what I run across, letting everyone know what's going on everywhere else.

VIRGINIA

Gerald Durwood Byerley
1041 W. Grace St.
Richmond, Va. 23200
(703) 355-3866

Has own Sony 1/2" portapak. Is used as extension of my work as painter, sculptor as well as extension of some limited background in film.

Eugene Productions
1239 Ingelside Ave.
McLean, Va. 22101
(703) 356-8406

Private, non-affiliate, SCS (single camera system) half-inch Panasonic 8100 series and standard (EIAJ). Interested in "in-being" vibe theatres, what they are doing and what they are showing.

Virginia Commonwealth University
Art, Ed. Dept.
Richmond, Va. 23220

School has General Electric and Shibaden 1/2" equipment. Contact for further information.

WASHINGTON

Eyecon-Fourth World Cyber Systems
P.O. Box 276
Seattle, Washington 98111
524-8633
776-0695

A life/technology/media group producing video and audio tapes and photo and graphic copy. Make a lot of tapes in the Seattle area. Trying to set up information access and feedback systems with community agencies.

Pro Bono Publico
Lynn D. Patterson
Box 1571
Seattle, Wash. 98103
ME 2-0328

Have access to half-inch equipment through the Public School system. Put on a video workshop with Media Access people. Interested in using 1/2" video equipment to facilitate community participation/information.

Seattle Souvenir Services

922 E. Alder
Seattle, Wash. 98122
(206) 682-5285

Have Panasonic and Concord 1/2" equipment. Artist use especially conceptual: community communications, eventual cable connections, video information networks.

WASHINGTON, D.C.

AECT/NEA
Richard G. Mibedo
1201 16th St. NW
Washington, D.C. 20036
(202) 833-4180

Harold Burke
1425 N. St., N.W. #502
Washington, D.C. 20006
(202) 483-0221
Using both Sony and Panasonic 1/2" and 1" equipment.

Community Video Center
1411 "K" St., N.W.
Washington, D.C.
(202) 628-5880
Working with a large supplement of Sony 1/2" equipment and a 1" editing deck they make tapes dealing with the Washington community. Interested in using video to facilitate information and turn people on to the potentials of CATV. Send for their tape catalogue.

Gene Davis
4120 Harrison St., N.W.
Washington, D.C. 20015
Abstract painter experimenting with portable video.

Educational Video Service
Rainbow Video
2115 "S" St., N.W.
Washington, D.C. 20008
(202) 387-5100
Have Sony 1/2" portapak and access to Sony editing equipment. Work with National Student Association. Interested in student/college video network and Cable TV access in D.C.

Nelson Wolfe
1740 "S" St. N.W.
(202) 387-8794

Video Software Inc.
3515 Lowell St., NW
Washington, D.C. 20016
(202) EM 2-4918
Working with both Sony and Panasonic 1/2" equipment. They are developing helical scan VTR as communication medium in the areas of business, education and the arts.

WEST VIRGINIA

Community Focus
1222 Washington St.
E. Charleston, W. Va.
(304) 342-3411
They have two portapaks and have access to one-inch equipment through Capital Cablevision also in Charleston.

WISCONSIN

Ron Ellis
Fort Atkinson, Wisc.
English Professor who uses 1/2" video to produce artistic pieces he calls "Plastic Poems," in his rural home.

Lee Ann Mason
Box 151 Rt. #3
Ft. Atkinson, Wisc. 53538
(414) 563-4281
English teacher uses video for instruction. Access to equipment through the University Media Services.

Eric McLuhan
Wisconsin State U
Stevens Point, Wisc. 54481

PUERTO RICO

Nebula
Experimental Video
Edin Velen
797 31 B Avedo St.
Rio Piedras, Puerto Rico 00923
Group of Puerto Rican video and audio artists using a loft gallery in which they feature showings from different video artists in the U.S. and Europe as well as their own tapes. Station manager at a local Ed. TV station is into radicalizing programming and has been working on different types of programs. Interested in a tape exchange.

CANADA

ALBERTA

University of Alberta
Myra Davis
Students Union Art Gallery
Edmonton, Alberta
432-4191
Have access to Sony 1/2" & 1" equipment through radio/TV Dept. Involvement in this area actually only involves playbacks. Starting a tape collection which will be available to students on request. Also we work with groups who are doing tapes to give them exposure.

XTV

Martha Fiedler
9740 87 Ave
Edmonton, Alberta
(413) 433-1208

Have 1/2" and 2" equipment. Have VTR use; interest-universal.

B.C. (VANCOUVER)

Christos Dikeakos
2676 W. 13th Ave
Vancouver 8, B.C.
(604) 732-5120

Have Sony 1/2" equipment. Street scan projects. "Art as a reflection of reality," gathering material to make 1/2 hr. precise programs.

Inner City Service Project

1895 Venables
Vancouver, B.C.
(604) 254-7166

Have Sony 1/2" portable decks and access to editing equipment. Training low income, self held community groups to produce programs.

Bill Jones

2340 Haywood Ave
West Vancouver, B.C.
(604) 926-4894

Using Sony 1/2" portapak. As a tool to advance personal aesthetic concepts.

INTERMEDIA

2023 E. 1st
Vancouver, B.C.
255-7358

Work ranges between video imagery, process documentation, cable programming and community media access. Using Sony 1/2" and 1" equipment.

BRITISH COLUMBIA**Box Arnold**

Winlaw, B.C.

Has 1/2" equipment (portapak) Time lapse video, satellite video, video video, box video, international video exchange

Diane Edmondson

Simon Fraser Video Workshop
Simon Fraser University
Burnaby 2, B.C.
(604) 291-4302

Equipped with both Sony 1/2" & 1" (video) systems . . . student use/cable-casting, connecting the univ. world with the outside world—self development with video feedback; making contact-giving people the television systems secrets.

Richard Ward

715 Shakespeare St.
Trail, B.C.
368-8114

Has Sony 1/2" equipment (2 portapaks) Documentary coverage suitable for cable-cast; showing local people how to make their own shows; helping to plan and establish VTR community facilities in interior B.C.

D. Luchich

2106 Trutch St. (or)
Box 6637
Vancouver, B.C.
(604) 738-9306

Have Sony 1/2" & 1" equipment for interview type programming, also for film purposes.

Metro Media

Bill Nemtin & Werner Allen
1923 Granville St.
Vancouver 9, B.C.
(604) 731-5611

Christopher Pinney

4533 West 2nd
Vancouver 8, B.C.
(604) 288-9676

Using both Sony 1/2" & 1" equipment for document real time, real space video.

David Rimmer

New Era Social Club
358 Powell St.
Vancouver, B.C.
(604) 681-9992

Use Sony 1/2" equipment. Interested in tape exchange, video environments, etc.

Andrew Selder

Laurel House
1896 West 15 Ave
Vancouver 9, B.C.
(604) 723-9812

Have Sony portapak for use in instructional and treatment methods with young emotionally disturbed children (especially autistic).

Dallas Selman

4533 W. 2nd
Vancouver, B.C.
(604) 228-9676

Has Sony 1/2" & 1" equipment. All of my interest in video is tactical in terms of my ego need to have my very own cable vision program called Pacific Documentary Armchairs.

Michael Tindall

TV Producer
Information Services
University of B.C.
Vancouver 8, B.C.
(604) 228-3131

Have extensive amount of Sony 1/2" equipment working on public information tapes and/or tapes of a general education or information nature which might be suitable for screening on campus.

Glenn Toppings

1927 Granville
Vancouver 9, B.C.
(604) 732-6012

Have both Sony 1/2" & 1" equipment. Working as a resource person for 2 metro-media. Teaching at university. Contrasts of life styles.

University Hill School

Jim Mueholland
2869 Acadia Rd
Vancouver, B.C.
(604) 224-5740

Have Sony 1/2" equipment. For use by students; varied subjects.

Don Whittred

Jericho Hill School
4100 West 4th
Vancouver, B.C.
(604) 224-1331

Have Sony 1/2" equipment. Affair-captioned-educational.

X-Kalay Foundation

D.M. Berner
26 West 7th Ave
Vancouver 10, B.C.
(604) 879-0661

Have Sony 1/2" stationary deck used for encounter gestalt, games, group hoo-haa's.

MANITOBA**Red River Community College**

Marcel M. Clement
2055 Notre Dame
Winnipeg, Manitoba
(204) 786-6218

Have both 1/2" & 1" VTR systems. Educational tapes, student production, community productions, TV commercials, documentaries. CATV Programs.

NOVA SCOTIA**Nova Scotia College of Art & Design**

Brian Lee MacMevan
A-V Dept.
6152 Corburg Rd.
Halifax, N.S.
(902) 429-1600, ext. 72

Have Sony 1/2" equipment. Used to document visiting artist lectures. Stealing good shows off CBC & CTV. Students, faculty, and visiting artists use VTR equipment to deal with their own art.

ONTARIO (OTTAWA)**Bell-Northern Research**

Mike Mills
Box 2511 - Station C
Ottawa, Ont.
(613) 828-2761, ext. 538

Using Sony 1/2" portapaks as well as 1" editing equipment. Exploring all phases of video with emphasis on visual (2-way) interactions. Hope to explore new technologies while evaluating the behavior produced. Extreme interest in computer video hybrids.

The National Gallery of Canada
Pierre Theberge
Ottawa 4, Ont.
(613) 992-9636
Have Sony 1/2". Gallery usage, displays, etc.

Simon Riley
5 Belvedere Cres.
Ottawa, Ont.
(613) 745-4381
Have Sony 1/2" portapak. Community cable.

Videotech
111 Sparks St.
Ottawa K1P 5B5, Ont.
(613) 232-7894
Using both 1/2" & 1" equipment. Involved in national study of video and cable use.

ONTARIO (LONDON)

Greg Curnoe
38 Weston St.
London 17, Ont.
(514) 438-5252
Have Sony 1/2" equipment. Video tapes on regional activities in Canada—particular in South London.

ONTARIO (WATERLOO)

D.R. Gordon
134 Iroquois Pl.
Waterloo, Ont.
(519) 743-1284
Has own Sony 1" EV 320 deck.

ONTARIO (TORONTO)

Bruce Emilson
424 Wellington St. W.
Toronto 2B, Ont.
(416) 366-0122
Has 1/2" and 1" equipment.

Environmental Cinemas
730 Yonge St. Suite 27
Toronto, Ont.
927-6869
Have a videotape theatre, called "Videoteque 9" which was opened as a prototype. Want to expand nation-wide. Interested in product software and are presently using color video tape compatible with the IVC 900.

Stanely M. Fox
Program in Film
Fine Arts Faculty
York University
4700 Keele St.
Toronto, Ont.
(416) 635-3244
Have 1/2" portapaks. Student use—original production.

General Idea
87 Yonge St.
Toronto, Ont.
368-7787
Have access to equipment from other independent groups, including the Toronto Dance Theatre.

Liya Hutchison
Software Coordinator
Instructional Media Center
University of Toronto
123 St. George St.
Toronto, Ont.
(416) 928-6049
Have all formats including 2" Ampex; use for university instruction and supplementary material.

A Space
85 St. Nicolas St.
Toronto, Ont.
A non-profit corporation whose main concern is the organization and programming of a large gallery space. Sony 1/2" equipment.

Moses Znaimer
#2400 401 Bay St.
Toronto 103, Ont.
(416) 927-5137
Has Sony 1/2" equipment and access to 2" broadcast equipment at local TV studio.

QUEBEC (MONTREAL)

Howie Arfin
7899 Wavell Rd.
Montreal, Que.
(514) 482-1883
Have 1/2" production unit and 1" editing facility. Involved in community orientation, animation turn-on to hardware, inspiration for software glow . . . towards the general benefit.

Nelson Becker
3522 Park Ave.
Montreal, Quebec
843-5492
Has access to Sony 1/2" and IVC 1" equipment through many sources in the Montreal area. Says almost all of the universities in Montreal have equipment.

Pierre Bedard
(Inter-Video)
1620 des Pins W.
Montreal, Quebec
(514) 935-7293
Has Sony 1" system. Refund a \$75,000 investment and having fun making long feature films.

Ronald M. Bduner
3601 rue Ste. Famille
#601
Montreal 130, Quebec
Has Sony 1/2" portable and studio equipment. Video in groups—social animation.

Challenge for Change
Dorothy Todd Henaut
National Film Board
Box 6100
(514) 333-3365
Montreal 101, P.Q.
One of the first groups to use 1/2" video as a social change catalyst. Using both Sony and Shibaden 1/2" equipment.

Community Media
Dawson College
535 Viger St.
Montreal, Quebec
(514) 849-2351
Have Sony CV & AV 1/2" systems. Involved in workshops, community access, community television, community cable.

Mireille Dansereau
827 Marie-Anne
Montreal 176, Quebec
(514) 527-1633
Have 1/2" system. Travail avec comedians. Capsules video—Ministere de L'Immigration. Psychodrama—avec living theatre.

Linda Gaboriau
1195 St. Marc
Montreal 108, Quebec
(514) 937-1536
Have Sony 1/2" portapak as well as IVC 1" system. Alternate information "Eye to Eye" monologues.

Loyola College—Montreal
S. Katy
Dept of Psychology
John E. O'Brien
Communications Art Dept.
(514) 482-0320
Both these depts are using Sony 1/2" equipment in their studies respectively.

Orba Film, Ltd.
Robert Rumel
418 St. Sulpice
Montreal 125, Quebec
(514) 844-9067
Work with Sony 1/2" equipment.

Parallel Institute
P.O. Box 6—Station D
Montreal 104, Quebec
(514) 933-2262
Have Sony 1/2" system, portapak and studio deck. Also various 1" machines from schools and industries working with citizens committees, using video as a tool for community organizing.



Merrily Paskal
Box 151
Shawbridge, Quebec
(514) 224-2441
Has use of Sony 1/2" equipment through the University—English Dept.

Costanza Passarelli
Paah Ex cc Training Program
8175 Durocher
Montreal 303, Quebec.
Has Sony 1/2" system. Information, training, documentation.

Louis Portugais
Office National du Film
C.P. 6, 100
Montreal, Quebec
Access to Sony 1/2" equipment through CATV system.

Multi-Media
Media Centre
C.P. 944
Montreal 101, Quebec
(514) 739-5956
Contact us through the use of: sound, films, video, photographs, written papers, printed matter, documents, individually, in groups. Contact yourselves, think about it, put it down and mail it to us before Feb. 25th, 1972.

Eva Russel
19 Cote Ste. Catherine
Montreal 152, Quebec
(514) 272-1051
Have Sony 1/2" CV series system. Recording and studying creativity in children.

Adam Symansky
3500 Mountain St.
Apt. 23
Montreal 109, Quebec
Has access to various 1/2" and 1" equipment. Interested in use of video in group and individual interaction and particularly in experimental methods of distribution.

Video Ensemble
515 Viger St.
Montreal, Quebec
(514) 842-5267/8
Has both Panasonic and Sony 1/2" equipment. Government grant from Secretary of State office for abstract and community projects.

Hyman Weisbord
880 Anvers Ave
Montreal 303, Quebec
(514) 277-7295
Has Sony 1/2" system. Self help through video playback—with the mentally retarded, video exchange re parental problems with retarded children.

QUEBEC

Marcel La Pointe
S.A.V. 5185 de Konwich
Universite de Loyal
Quebec 10E
(418) 656-3124
Have 1/2" and 2" equipment. Je suis interesse a recevoir differentes experiences de TV communautaire, ainsi que des emissions underground Americaines ou canadiennes.

ALGERIA

Black Panther Party - International Section
B.P. 118 Grande Poste
Alger
78-21-05
A video tape program has been developed to be directed to the U.S. & Europe on a regular basis to cover the spectrum of the international anti-imperialist revolutionary movement. In the process of building up a tape library for information, research and distribution purposes.

AUSTRALIA

W.A.I.T. Media Workshop
Lyn Mincherton
Architecture Dept.
Western Austr.
Hayman Rd
Bently, Western Australia 6102
681931
Have Shibaden 1/2" & Ampex 1" equipment. Communicative medium in planning proposals—retaining old bldgs. information exchange between schools of architecture.

ENGLAND

Conrad Atkinson
44 Ledbury Rd.
London W11
(01) 727-4312
Has Akai 1/4" portable. In combination with other techniques as both a socially "liquifying" mechanism and as a documentary mechanism.

Hoppy-Vision Teleproductions
77 Prince of Wales Rd
London NW5 3LU
Have Sony 1/2" (CV series) equipment. TVX is dead. Vision lives. European & V.S. Systems totally incompatible, but there's so many visiting Americans that AV tapes from U.S. are quite acceptable.

North Kensington Community Television
Michael Hichie
837 A Fulham Rd
London SW 6
(01) 736-0533
Has Sony 1/2" system. Engaged in the setting up of a community television service in North Kensington, London.

Gregory Lobotomowski
43 King St.
London WC2
"Oz" Machine
Felix Dennes
52 Princesdale Rd
London W 11
(01) 229-7541
(01) 229-4623
Have access to equipment through TVX but are aiming to produce a newspaper with a heavy video feature each week. Will be called "INK" Newspaper.

FINLAND

Jo Mallander
Villagatan 12
Helsinki 15
Trying to get together a video group in Finland. Does not have American equipment.

GERMANY

Falk-Wang-Gabrie
Essen
Has European Std. Ampex 1" deck.

ITALY

"9999"
Via S. Agostino
5 Firenze
50125 Italy
281-154
Group running an experimental architectural school called S-Spare. Not sure if they are into video.

JAPAN

Takahiko Linavra
4-50-4 Yamato-Cho Nakano-Ku
Tokyo
(03) 312-2545
Have made 10 pieces in video tape . . . more than six hours but no place in Tokyo for showing. Using Sony 1/2" equipment could be Japanese correspondent.

NETHERLANDS

Joe Pat
Rotterdamse Kunststichting
Rotterdam Arts Foundation
AFD. Tentonstellingen, Kruisplein
30 - Rotterdam
Setting up a video News Service, contact for more information. Have 1/2" and 1" systems.

Tagiri Shinrich
Kasteel Scheres
Barre, Holland
(04707) 207
Has Sony 1/2" American standard 525 lines and is willing to help translate tapes into European 625 without charge. If there are any video freaks wandering around the south-east part of Holland, we're located on the Dutch-German border.

Videoheads
Jack Moore
Klarendalseweg 31
Arnhem
Nederland
A group producing various AV materials, using Sony 1/2" video equipment involved mostly in experimental, entertainment type programming.

SWITZERLAND

Gandja Films Group
Circa and Jose-Maria Mondelo
5 Rue Pierre Fatio
1200 Geneva
A group of underground cinema people working with 8 & 16 mm. Studying the possibilities of creating an alternate television group in Geneva.

Stanislas Gard
Le Martinet
Bagnes, Valais
Will establish in Paris and possibly also in Geneva, a video center which comprises a video theatre, video-teque, a videomagazine and one or more production and research units.

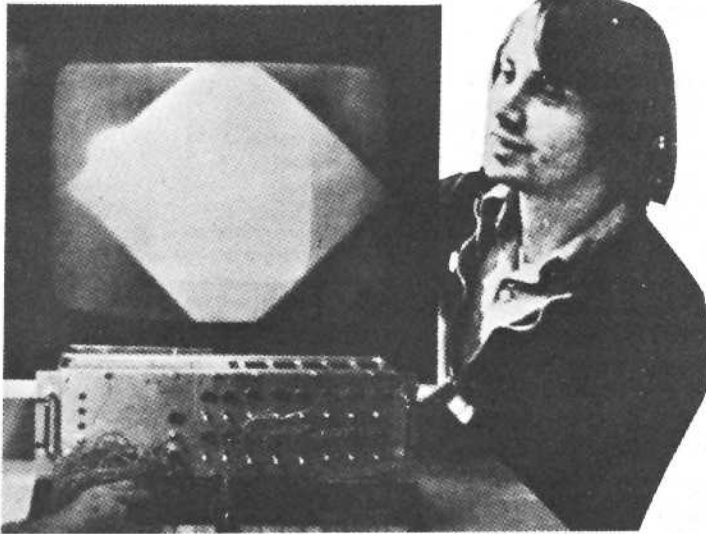

ERIC SIEGEL'S VIDEO REPORT: A Half-Inch World Video Standard; The European Scene; Electronic Correction; Videotape Publishing

Since the very first issue of *Radical Software* I have been writing about video standards. In issue number 3 I advised everyone to adopt the American 525-line standard. This seemed rational for Americans, but Europeans may have thought that I had some ulterior motive for pushing American equipment in Europe. The only motive I had was compatibility.

Now, however, I have devised a way to modify Sony type-one standard equipment so that it can also be used in Europe. In all half-inch battery operated portable VTR's there is a servo-locked head motor drum motor. American machines (in the head-drum servo) are tuned to free run at a 60-cycle alternate current driving frequency. The motor hovers at a harmonic multiple of the vertical scan rate which is the same as 60-cycle house main current.

In order to make an American standard recorder work on the European standard you readjust the driving oscillator free-running frequency to 50-cycles which is the European house main current. With this simple adjustment you can have a "world standard" half-inch videotape recorder with an American VTR and further more, all 625-line (European) tapes will be compatible with 525-line standard AV machines, which change the driving oscillator from 50 to 60 cycles. If you have a Sony AV3400 VTR the addition of two 4.7 k ohm resistors (one a series R526, the other series R527) with shorting switches across both resistors will make your machine switchable from 525-line American to 625-line European standard.

I spent last summer in Europe and demonstrated the convertible standard to video pioneer Jack Moore who subsequently has purchased an American standard (AV3400) videotape recorder. I also met another group in Paris who will also be using American standard equipment. So a true world standard may be on its way.

You have all made videotapes which contain very valuable information but which, unfortunately, have very poor quality. One of the major problems is shifting black level, which is caused by the automatic target control in the Sony AVC3400 camera. In a previous article I described how to modify your camera to eliminate this problem in the future, but this doesn't rectify tapes which are already ruined.

As you know, I have developed a special device known as the *processing Chrominance Synthesizer*. Among the various things that it does is black level correction, i.e., it enables you to manually correct black level inaccuracies. It also allows you to increase the contrast, and it fills in sync. pulses where drop-out is present on a tape. It also makes new blanking signals, new synch. signals, and it allows you to color synthesize black-and-white tapes into color. In the future it will incorporate gamma correction which gives a better tonal range to the gray scale, and image enhancement circuitry to make the picture sharper and crisper than it was originally. Thus, with one device most of the technical problems of half-inch video will be solved.

Many people wish to put their videotapes on the air. This has been done in America already. The technical process by which this is accomplished is called "scan conversion." Although American half-inch VTR's have the same scanning rate as those used on broadcast TV, they don't have the same stability. Therefore half-inch tape must be re-scanned by an accurate broadcast TV camera or an electronic scan converter. The heart of the scan converter is a special tube that looks like two oscilloscopes cathode ray tubes face-to-face. One tube scans the image from the half-inch tape. The other tube picks up the image for broadcasting.

If you can't locate a scan converter and wish to put your tapes on the air, a simple scan converter can be made by feeding your tapes into a keyed-clamp, high quality, high-resolution monitor and then focusing a high quality broadcast camera on it. If both scanning rates are the same (525 lines or 625 lines) then you can use a plumicon camera. If one scan rate is different from the other, then a vidicon camera must be used so that a retention of the image is produced thus eliminating the inter-scan beat frequency which is a 10 cycle flicker in the picture.

Sooner or later you may be contacted by a cassette company for rights to publish your half-inch video work. If you have already signed a contract you can consider it a blunder. However, if you haven't yet, I advise you not to.

Here in New York City at the present time there is a group of people including myself who are in the process of arranging a suitable organization to establish a world standard for videocassettes. If you are interested write me: Eric Siegel, c/o Howard Wise, 2 West 13th Street, New York, New York 10011; or call me at (212) 253-0082.

A RADICAL SOFTWARE STATE-OF-THE-ART REPORT



PANASONIC'S
Deluxe 1/2" Editor (Model NV3150)

EDITING DECKS

Completely reliable editing in half-inch video is not yet a reality, although the Sony AV3650 is highly useful relative to its size and cost (Retail: \$995.00; standard discount price: \$845.00). You can edit with complete success on a one-inch machine but that requires between \$4,000 and \$5,000 just for the deck; one-inch tape is twice as expensive as half-inch; and there's no compatibility between one-inch machines so your master tapes can only be played back at your place.

Thus, two companies have announced improved half-inch editing decks (compatible with all type-one standard machines), one of which promises to be the equivalent of a super one-inch editor except that it will use half-inch tape.

Both Panasonic and Ampex claim they will be selling top quality half-inch editors in the spring. Panasonic calls theirs a model NV3130. Ampex's is a model VR-420. Panasonic not only claims their deck will do perfect insert and assembly edits, but it will also be a half-inch color deck, and will have a drop-out compensator. The Ampex machine will be black-and-white and will utilize two motors, for added reliability, instead of the single motor system on current half-inch decks.

Ampex says their deck will sell for \$1,200 and will be available in April. But with Ampex it's hard to know. If they do market this machine it will be the first half-inch equipment they've ever sold. This includes their Instavideo unit which they've been promising for two years now and have put off three or four times. Moreover, the company lost \$40 million last year. Thus, while their one and two-inch equipment might be the best, their record of mismanagement makes one skeptical of their ability to deliver a reliable deck in the near future. Especially because the first months production of any new video equipment guarantees that the first purchasers have to do a company's field testing. We got burned a bit by buying the very first of the Sony AV line which wasn't as reliable as subsequent models.

As for Panasonic, they say that their half-inch deck will list for \$1,500 and be out sometime in the spring. But more important than the NV3130 model is one they call the NV3150. It will list for \$3,000 and have all the features of a good one-inch machine, including solenoid switches, two-track audio, and the drop-out compensator. Panasonic isn't quite sure, however, exactly when the deck will be available and this fall is probably the earliest, if then.

PORTA-PAKS: Sony, Sanyo, Akai, Nivico, and Ampex

When our correspondent visited the Sony factory in Tokyo last summer he was told that they are working on a lighter, more compact portable VTR. But the chances of there being a Rover III (we're currently at Rover II) in the next year or so are very slim.

Meanwhile, Sanyo has put out a brochure describing a half-inch cassette Porta-Pak which, with camera, weighs only 13 pounds (compared to 21 for the Sony). It is not compatible with anything but itself, runs at a slower speed than type one standard, has an optical instead of an electronic viewfinder in the camera, and can only record up to 12 minutes before you have to put a fresh tape in. Sanyo (which also makes Craig equipment) hasn't announced prices or delivery date yet.



SANYO
1/4" Videocassette Porta-Pak

Since we last wrote about portable video equipment (issue 3) Akai has charged up their sales network and their quarter-inch tape portable is now easy to get. From what we hear it is a good machine. But again there is the problem of its incompatibility with all but its own standard, and the lack of editing back-up. Some people are into taping maskers with the Akai and editing on Sony, which seems to work.

There is also a new half-inch portable being marketed. Its manufactured by Japan Victor and sold under the brand name of Nivico. It is type one standard and seems to be a duplication, feature for feature, of the Sony Rover II. Whether it's better or worse we don't know.

And, finally, there is Ampex Instavideo. It was the fall of 1970 when Ampex announced its Porta-Pak and showed a demo model at trade conventions. Delivery date: spring of 1971. In spring of 1971 Ampex announced they wouldn't be available until the fall. Now, of course, it's almost spring of 1972, and still no Instavideo. Postponed until 1973. What with Ampex's \$40 million loss last year we may never see it, along with EVR, and RCA's legendary laser-plastic tape videocassette player; all casualties of corporate egotism where prototypes and public relations were supposed to convince stockholders that their companies were right in there with the newest consumer technology when, in fact, they were unable to deliver.

A RADICAL SOFTWARE STATE-OF-THE-ART REPORT



TAPE

Tales of cheap videotape are like talking about the weather. But every now and then real, if somewhat flawed, deals do pop up. Two companies are selling videotape at very low prices. An outfit called EHI (P.O. Box 20643, San Diego, California 92120) is listing 30 minute tapes for \$5.50 a reel in quantities of one to nine; \$5.10 a reel for ten to twenty-four; and \$4.75 for twenty-five to one hundred. Beyond that they encourage you to write for special prices. On the same quantity scale, hour tapes are going for \$9.25, \$8.45, and \$7.70. These prices are about 40% of the wholesale price of Sony videotape which itself is about 40% off the retail price. We have written EHI asking how they can sell so low but never got a reply. We imagine that they are selling re-processed tape and the one sample roll we had resembled Memorex Chroma and seemed alright for dubbing, but not for taping masters.

Another company, Dak Enterprises (P.O. Box 69920, West Hollywood, California 90069) is selling reprocessed tape, and at about the same prices. Audio tape too, cassettes included. They will send free sample reels.

Finally, there's so-called high energy tape which is supposed to store a cleaner, more powerful signal. We've tried some (Scotch), but haven't noticed any difference. Price is about 40% more than regular Sony tape. Still inconclusive. If you have experience please write us.

DEALERS

No one buys equipment at list price in Manhattan. But because demand often outstrips supply, one day's prices are gone the next, and people who you relate to as your friends nonetheless try to screw you. Naturally, we all expect the lowest prices possible. Some of the dealers will accommodate us, but other who deal mainly with industrial clients and large companies do not discount as heavily as those in touch with the video groups.

We (Raindance) do this: We first go to Technisphere (141 Lexington Avenue, New York City, 684-3136) where we know we can get good prices, honest information on delivery, and reasonably reliable back-up service. But because the owner, Jack Goldman, does not yet have a Sony dealer franchise (he does have a Sony service franchise), he must get his supplies from other dealers and thus cannot always fill an order.

If this is the case, we then call C.T. Lui at C.T.L. Electronics (86 West Broadway, New York City, 233-0754) who, because he is a dealer, often has stock. But, while Lui's prices are often the lowest possible, he has sometimes reneged on a deal after it was made. Moreover, he sometimes tries to sell new equipment that has been opened.

While Lui maintains that this is just to get a spare accessory, if you are paying fair price than it is not unreasonable to ask for sealed equipment. Lui's service, which was terrible in the past, has greatly improved under the guidance of John Brumage. Moreover, Lui has pioneered in equipment modifications and is usually well-informed about new possibilities. So check-in there and compare prices before you buy.

The third outfit with which we deal is Harvey Radio (Pro A/V Division, 444 Madison Avenue, New York City, 832-8675) which, when it has stock (which is usually), maintains discount prices as low as anyone in town. Harvey Radio is also a franchised Sony dealer. Also a good place to check before you buy.

Those of you are familiar with the dealers in New York will realize that several names are missing from this list. This is for two reasons. One, because the companies simply don't give good prices. Or two, because we feel we have been screwed by them in the past.

RANDOM INTELLIGENCE

Sony half-inch equipment can be purchased in Hong Kong at prices less than in Tokyo. An AV3400 (Porta-Pak) camera is \$500; the AV3400 deck is \$620; and an AV3650 lists for \$830. Then, if you buy in person and pay cash you can get a 15% discount. If you order by mail figure \$55 for shipping and handling, but that doesn't include duty. Address inquiries to: Fook Yuen Electronic Co., Ltd., 1106 Hang Seng Bank Building, Des Voeux Road Central, Hong Kong.

Both Eric Siegel and Nam June Paik have shown their video synthesizers in New York this winter. Paik's mutates a camera signal and adds fabulous colors, while Eric's can generate its own imagery without external input. Both are spectacular if you're interested in video imagery.

The Videofreex have built a custom camera for Shirley Clarke which allows her to wear the lens and vidicon on one arm and the viewfinder in her hand. The Freex made it from an old CV Porta-Pak camera.

Technisphere in New York City (141 Lexington Avenue, New York, N.Y. 10016) can modify the Sony AV3650 editing deck to eliminate the sound lag problem. They are charging \$25 for the modification. The problem is that with Technisphere's change you can no longer do video inserts with the 3650. So it's a trade off, inserts for no sound lag.

The CMX600 is a computerized electronic editing system which costs \$380,000.00. Developed by CBS-TV and Memorex, it allows random access to thirty minutes of video information frame by frame and can do dissolves, jump cuts, and other optical effects. Once you've decided on sequencing and effects the computer mixes your tape automatically adjusting for color correction if so instructed. Its designed, of course, for two-inch tape and super-commercial uses.

Equipment prices are going up. Sony is adding \$150 to the list price of its VTR's AV3650 and AV3400 (Porta-Pak). And the other manufacturers are following. It seems that the Japanese are into price fixing, which is illegal for American companies, theoretically at least. (The price of videotape isn't expected to go up a while, however).

A RADICAL SOFTWARE STATE-OF-THE-ART REPORT

FILM CHAIN ADAPTER

A lot of good information lives on 8mm and 16mm film, but very few people have gotten into transferring it to videotape. Sony makes an attachment which takes an image out of a movie projector and prisms it into a C-Mount video camera (e.g. a Porta-Pak camera). But they manufacture it for their European catalog.

However, Harvey Radio in New York City (444 Madison Avenue) stocks some of Sony's European line, the film chain adapter included. It's a good thing to have if you want to multiply access to your films. PRICE: \$125.00.

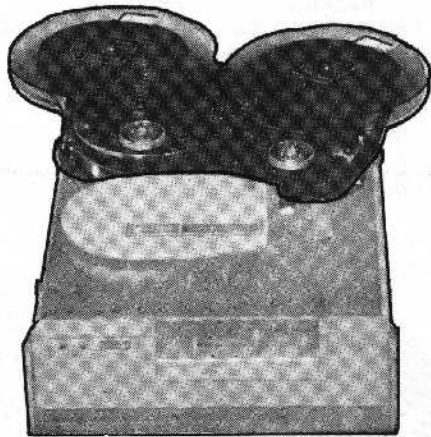

PORTA-PAK HOUR REEL CONVERTER

In a stationary situation the Porta-Pak deck can be a hassle because the longest tape it uses is 30 minutes. If you are taping with just one deck, the activity either has to stop while you change reels or the activity goes on and you're unable to tape it. Not a major problem but for people with just a Porta-Pak deck an hour adapter might be useful.

You can buy a clip-on module to use hour reels on a portable deck from Scan Rate Inc., 27 Palm Court, Paramus, New Jersey 07652. PRICE: \$189.95.

TIME-LAPSE VIDEO

A company called Odetics in California modifies Shibaden and Sony decks (the Porta-Pak included) to do variable speed time-lapse recording. Write Odetics for prices at: 1845 South Manchester Avenue, Anaheim, California 92802.

VIDEOCASSETTES: Sony, Panasonic, Cartrivision, and the death of EVR

They're here. Almost. Sony is selling their playback only machine (color, stereo sound) for \$800, and a record/playback deck for \$1,295. Our Sony dealers in New York have already placed orders and Sony itself says they are selling them. Moreover, one commercial tape house in Manhattan has tooled up to do mass dubbing (Teletronics) so Sony seems serious about it. We transferred one of our half-inch tapes at Teletronics and the copy was excellent. Very encouraging given the potential of cassettes for distribution. More important, the Sony cassette recorder can be used for dubbing as you would with an ordinary half-inch deck. Thus, no middle man. The Sony

machines are, of course, three-quarter inch tape and some rumors have it that Sony is abandoning their half-inch line for the newer standard. While it is true that they discontinued all half-inch color recorders (i.e. the AV5000a), our correspondent visited the Sony factory in Tokyo last summer and was assured that production is expanding. Moreover, Sony is now selling 1,000 Porta-Paks alone in the United States each month.

Panasonic has also announced a three-quarter inch machine which will be compatible with the Sony. (Just to play it safe they're also going to market a half-inch, type-one standard, cassette player. So who knows). All we know is that Sony is serious, has a proven record of consumer selling and servicing; and their machine is beyond the prototype stage and operates very well. Moreover, you can use it with any TV set (the off-air record model has a built-in broadcast tuner).

On the other hand, Cartrivision has taken big newspaper ads announcing that Sears is selling their unit (delivers in June) for \$1,600. But that includes a built-in TV set as rumor has it that the Cartrivision cassette deck isn't stable enough to feed any TV.

Cartrivision is using a software first approach and thus is concentrating on consumer sales whereas Sony seemingly has no notions of programming and is aiming for the institutional market. The Cartrivision catalog of tapes includes every old movie and educational film imaginable, and not one thing produced especially for the medium. But they are moving quickly into the consumer area (Time Inc. will also be marketing their material through Cartrivision). Meanwhile, their stock, which was issued at \$20 a share, has doubled in price.

Finally, prices for pre-recorded cassettes will range from \$5 to \$30 and feature-length films will be rented for \$6. (Sony 60 minute cassettes: \$35 blank). The \$1,600 price also includes a black-and-white camera to plug into the console recorder. They are obviously serious, especially since Sears is making its service network part of the deal. The system is not compatible with any other and Cartrivision is saying that "Survival of the Fittest" will prevail. Honest. That's from their advertising copy.

Given the imbecilic quality of their catalog ("How to Stop Smoking," "Nepal: People of the Mountains," "Reducing Executive Tension") and the fact that the hardware itself is a conspicuous consumption item (at a time when the national economy is still sluggish), Cartrivision will be a test of whether the mentality of broadcast television can prevail in videocassettes.

Already, of course, there has been a massive failure because of lack of insight into videocassettes as a new medium. That is (or was) the CBS EVR system which they have discontinued at a \$10 million loss. Everyone but CBS knew that a video playback system based on film technology was not going to make it, but they pushed on anyway, trying to substitute public relations for good design, and marketing surveys for common sense.

この様な社会の要請に従い、古河電工、東通、日本映画出版、旺文社の4社は協力して、通信メディアとしてとつのが有力なタイプである「CATV」(有線テレビ放送)に関する、日本最初の総合コンサルタント会社—日本シー・エー・ティ・ヴィ(株)を発足させました。これはさまの住まわれる地域に、それぞれ適正な規模の通信

A RADICAL SOFTWARE STATE-OF-THE-ART REPORT

AUDIO SHMAUDIO

Electro-Voice has a new directional mike that seems to be a good mate for the Porta-Pak. It has a volume control on the body of the mike and allows you to lower the level of sound going into the pak. This is a very useful feature in those loud sound spaces where you'd normally get distorted sound with the Sony Automatic Gain Control (AGC). It must be said that even video tapes of loud conversations have distortion caused by the poor Sony circuitry. The number of the microphone is Electro-Voice 670V and the price is about \$50.00.

IMPROVING THE VIDEO SOUND

There is an electronic system of improving sound on video and audio tape recorders. The marvel is called a Dolby noise reduction unit and costs from \$50 to \$250 depending on the quality (There's also a \$1500 professional unit). The cheapest is the TEAC AN-50 at \$50.00. What the machine does is improve the signal to noise ratio, making the sound cleaner. However, it has to be used during recording and playback. It lowers the noise inherent in tape by 10 db or 90 %. Advent, that nifty company, makes the best and most expensive Dolby units with prices from \$125 to \$250.

Improving the sound of prerecorded tapes requires something like the Metrotec graphic tone control or equalizer (FEK-1) at about \$75 with a discount. This little thing can select sounds of five different frequencies and either decrease or increase them. It allows you to get rid of noise masking a desired sound. An example would be cutting out the sound of traffic on a tape of a street interview and boosting the sound of the voices.

LENS ADAPTORS

Extenders or extension tubes for a C mount lens (video camera) can be obtained from Bolex (\$26 for a set of four) and Spiratone (\$6 for a set of three). We have a Bolex set and they're very good for macro or detailed close up work. You change the magnification range with the different size tubes, however, they don't turn a normal lens into a wide angle lens and are only good for a limited range of the zoom lenses. Spiratone also makes what they call a Tel-Extender for C mount lens. It doubles the power of your lens and sells for \$19.95. Spiratone deals with people by mail and their address is:

Spiratone Inc.
13506 Northern Blvd.
Flushing, N.Y. 11354

OWNERS OF BATTERY BELTS

If you have a BP 30 you should adapt it so it can be charged from the Porta-Pak's power supply. The power supply will not over charge the battery belt. The charger Sony gives with the belt is unregulated (has no feedback from the battery that says it's had enough) and can over charge and ruin the belt. Over charging can happen if you leave the belt charging too long.

TECHNO CATALOGS

Some good catalogs to send for if your into building hardware and surplus equipment.

B & F Interprises
P.O. Box 44
Hathorne, Mass. 01937

Cheap IC's, electronic and optical

Gerber Electronics
852 Providence Hwy.
US Rte. 1
Dedham, Mass. 02026

Wide range of cheap IC's,

Denson Electronics Corp.
P.O. Box 85
Rockville, Conn. 0600

"World's Largest Selection of new and used TV cameras and Equipment."



THE EGG STORE
VIDEO FACILITY

THE EGG STORE is a new production and editing facility developed by C.T.L. Electronics and Frank Cavestani, and located at 146 Reade Street, just two blocks from C.T.L.'s showroom and service department. The primary function of The Egg Store is to provide a high quality production and editing facility for both 1 inch and 1/2 inch video tape, and to offer an environment for experimentation in the art and technology of video production. In addition, material can be transferred from 1/4 inch Akai, 1/2 inch CV, 1/2 inch AV, super 8, 3/4 inch cassette to 1 inch for editing, and then transferred back to the original format for distribution. Material shot on Akai, Sony, Panasonic, Javelin, IVC and Ampex equipment can be handled at The Egg Store.

The studio will also be equipped for multi-media presentations including film, slides, audio and live actors, dancers and musicians.

Special considerations will be given to artists and non-profit groups to use the facility during unscheduled hours at a nominal fee. Careful consideration has been given to the needs of the video community, including the capacity for closed circuit viewing of tape for audiences up to 40 persons. The close proximity of C.T.L.'s service department assures that the equipment will always be operating at the required standards. Artists and engineers are welcome at The Egg Store. For more information contact Frank Cavestani or Lynda Rodolitz at (212) 431-5293.

A RADICAL SOFTWARE STATE-OF-THE-ART REPORT

TIVICON: LOW-LIGHT VIDICON TUBE

Finally, it's possible to adapt a hand-held video camera so that almost any illumination becomes available light enough for taping. Ordinarily, in a dimly-lit room (e.g. a couple of table lamps) the standard video camera grays out. But with a Tivison tube the spectrum of light intensity begins to approach that of the human eye and in the red spectrum even surpasses it. The Tivicon is red sensitive so that, for example, intimate spaces washed in red light translate into bright daylight tones. Finally, a *Tivicon won't burn*. You can point it directly at a bright light, the sun included, and at worst it overloads into a blob of white tones, but no permanent damage is done.

Tivicon is the Texas Instruments company's name for what is actually a 2/3d's inch silicon dioxide vidicon tube. When they first became available last summer video dealers in New York were charging outrageous prices for installation. The tube itself lists from \$680 to \$450 depending upon the quantity purchased. Installation is relatively simple, about 20 minutes work, if you know what you're doing. Nonetheless the price in New York was \$900 installed (that's in addition to the purchase price of the Porta-Pak). There's a shop in Philadelphia called Impossible Electronics which still charges \$1,250 and tries to claim that it's a very difficult job. While the tube is relatively expensive, it's worth it, and here's how you can avert being overcharged.

GBC, a big video supplier in New York City (74 Fifth Avenue, New York, N.Y. 10003) buys Tivicons in quantity and will re-sell to any "professional user" for \$495. That means simply that they won't sell to individuals at that price, but all you have to do is have your own dealer order it or purchase it through an institutional front.

Another way to avoid the \$680 single unit price of a Tivison is to contact Texas Instruments directly. They have some factory rejects which they'll mail on consignment (i.e. no money up front). Generally the defect is a blemish on the face of the tube which manifests itself as a pin spot of light or dark. If it's not in the center then it can be pretty much unnoticeable. Moreover, the company includes an inspection sheet with their reject tubes indicating what the fault is. The price will be less than \$495. The person to contact is: Frank Skaggs, Texas Instruments, Inc., Mail Station 945, Post Office Box 5012, Dallas, Texas 75222.

Now, after you've gotten a tube for \$495 or less you shouldn't pay more for installation than the rate for an hour of a technician's time (generally about \$15 an hour). So your dealer won't try to claim it's a difficult task we've published complete installation instructions on the following page. That's all you need to install a Tivicon. No bullshit. No super-expertise. No outrageous price. We can't stress enough the added flexibility that a Tivicon camera gives to portable video equipment.

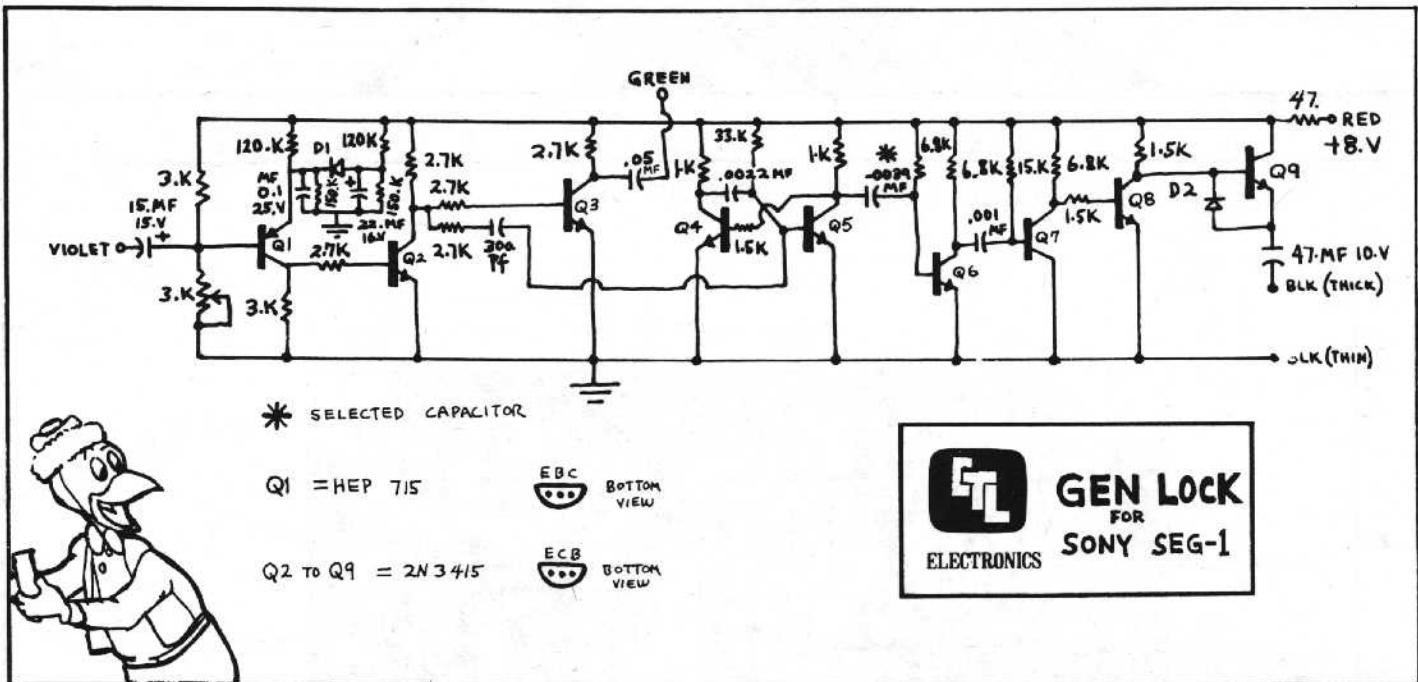

A GEN LOCK added to your Sony SEG-1 will allow you to perform wipes and fades between signals from a VTR playback and 1 to 3 live cameras. The GEN LOCK separates the sync signal from the video input and generates horizontal and vertical camera drive signals.

In operation, the GEN LOCK

modification board takes its power from the power supply of the SEG-1. The video connected to input 1 or the SEG is applied to the base of Q-1. The composite sync is separated by Q-1 and amplified by Q-2. Transistor Q-3 is the output amplifier for the vertical signal. Q-4 and Q-5 form a "one shot" monostable multivibrator triggered at the base

of Q-5 by sync pulses from the collector of Q-2. The horizontal signal is amplified and shaped by Q-6, Q-7, Q-8, and Q-9.

The coupling capacitor between the collector of Q-5 and the base of Q-6 is selected for the best horizontal phase. A .005 capacitor may be added between the collector of Q-7 and

ground to improve horizontal stability. If desired, C.T.L. Electronics can modify your Sony SEG-1 in their service facility at 86 West Broadway, N.Y.C (212) 233-0754. C.T.L. will also be publishing a catalog of equipment, accessories and modifications which can be obtained by writing and requesting a copy of "Video Tools."

A RADICAL SOFTWARE STATE-OF-THE-ART REPORT

**Tivicon:
MODIFICATION
FOR AVC-3400
VIDEO
CAMERA**



Do-It Yourself
High
Tech

1. Remove "P" Circuit Board behind case as shown on fig. 2-1 (fig. numbers correspond to SONY Service Manual for AVC-3400 camera).
2. Cut foil as indicated fig. 4-2 and schematic fig. 4-5. Connect free end of capacitor C201 0.1MF to + 9 Volt as shown.
3. Re-install "P" Circuit Board behind case.
4. Vidicon position adjustment: move screws to the rear as indicated on fig. 6-5.

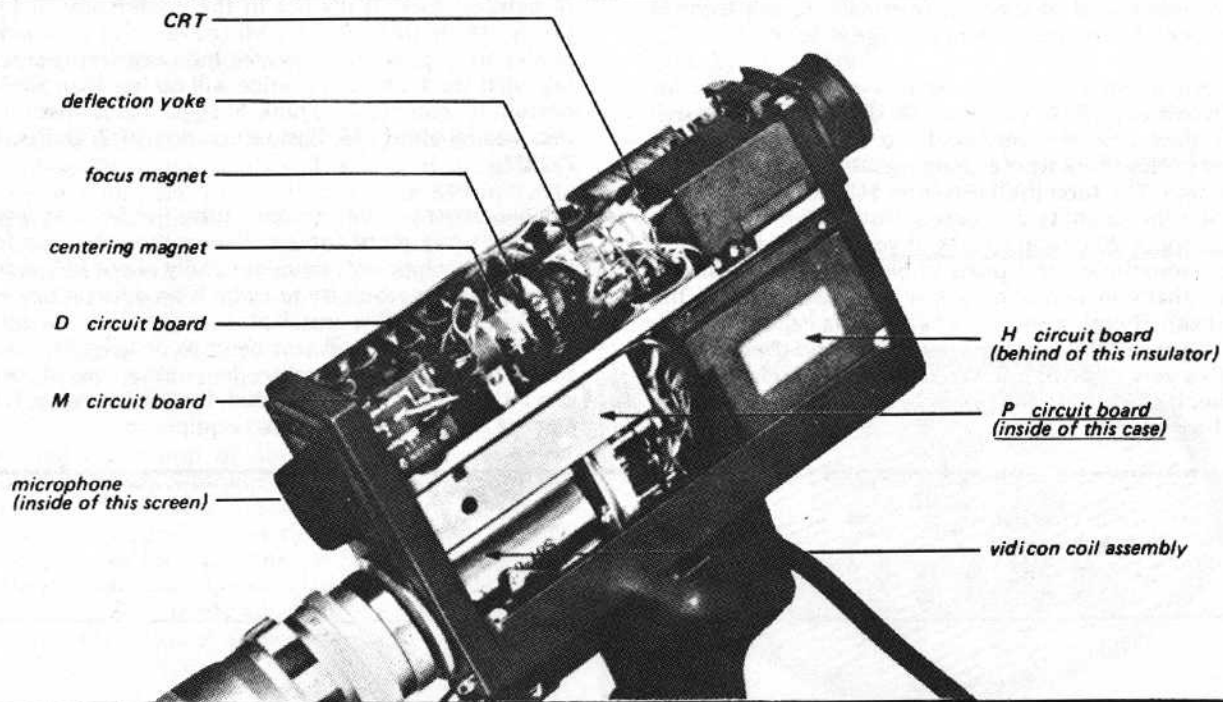

2-1

"P" VIDEO PRINTED CIRCUIT BOARD - CONDUCTOR SIDE

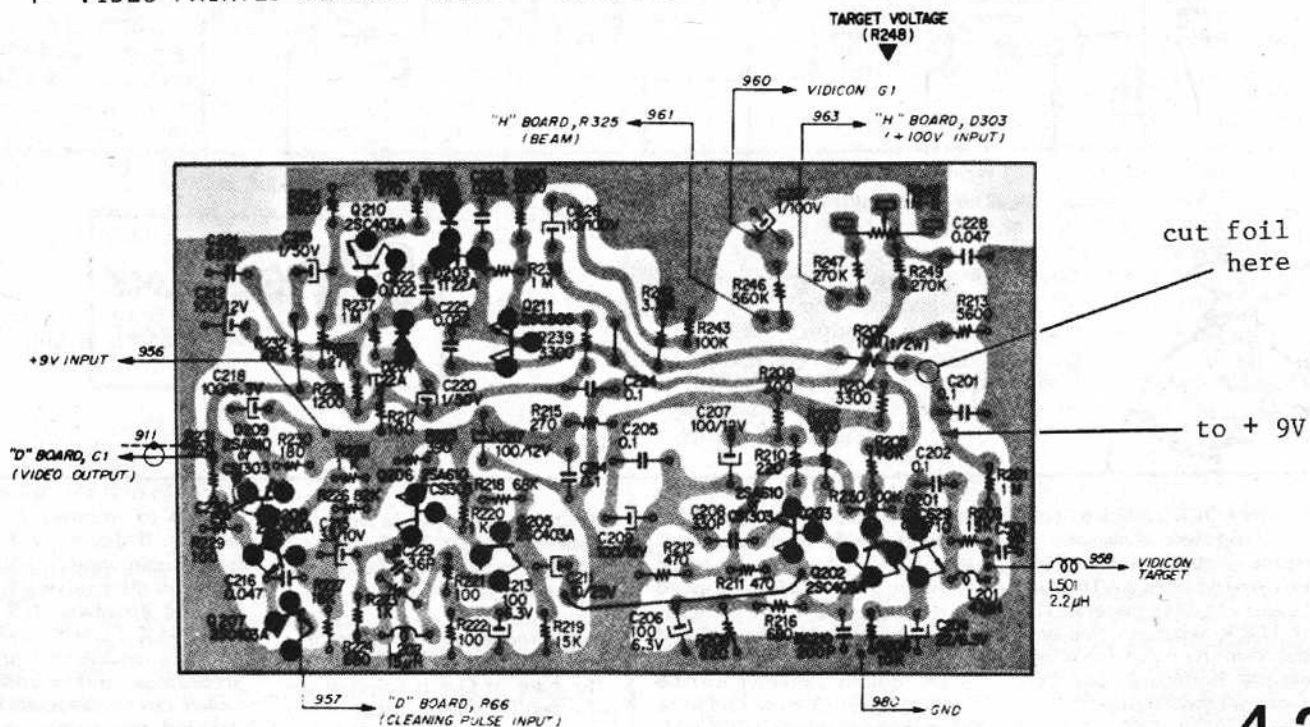

4-2

A RADICAL SOFTWARE STATE-OF-THE-ART REPORT

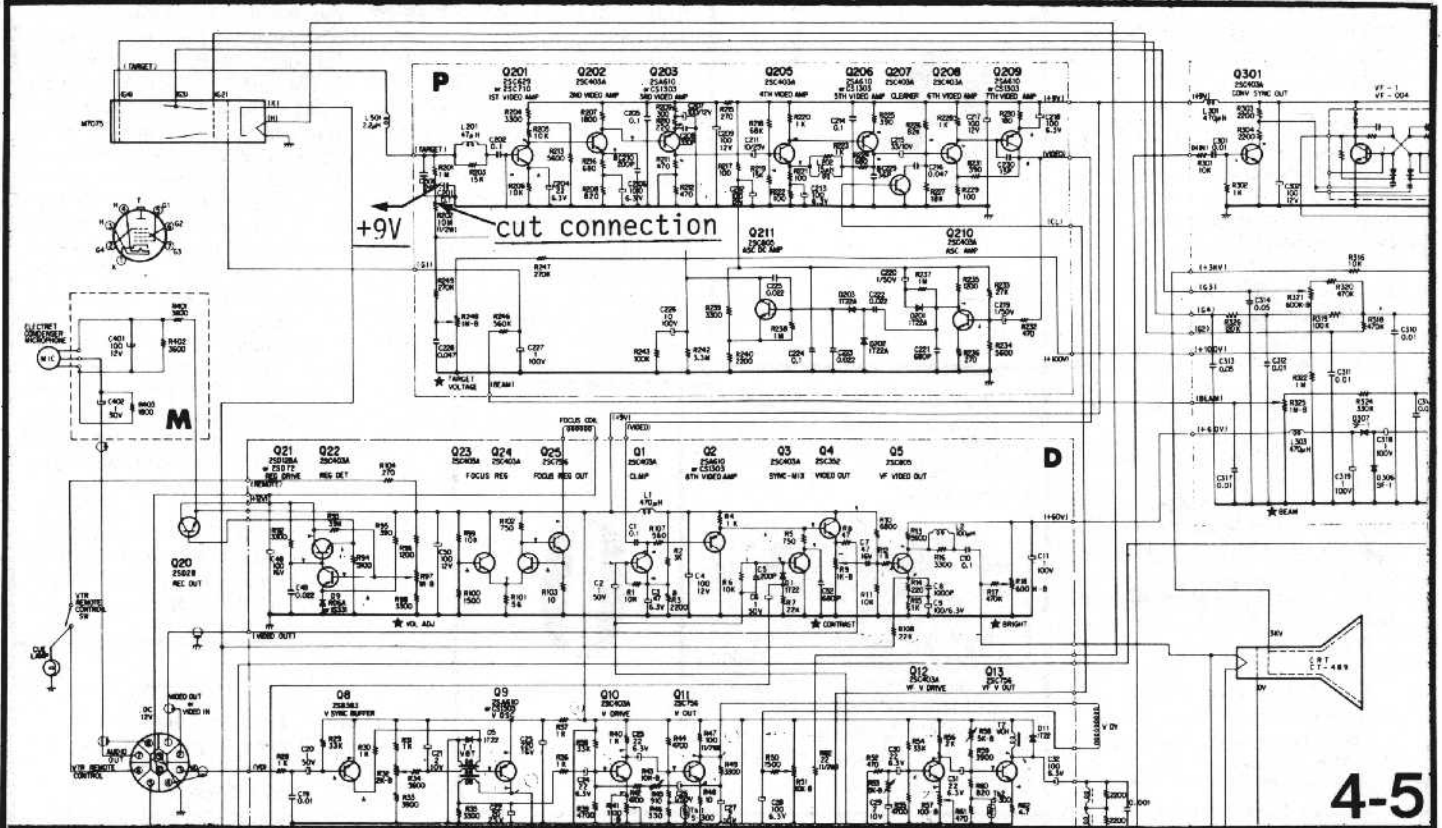

4-5

LOW-LIGHT-LEVEL EIAJ VTR

GBC CCTV Corp. announces the "total darkness" Porta-Pack camera/VTR system. The camera has a 2/3" Tivicon (developed for GBC by Texas Instruments) capable of producing a clear picture with only 1/1000 of a foot-candle faceplate illumination. It is also sensitive to infra-red, and includes a zoom lens, built-in microphone, and electronic viewfinder. The VTR is Sony's VideoRover II with stop action. Unit is expected to have wide application to the security surveillance/police fields. Total weight (including battery): 18 lbs. Delivery: immediate.

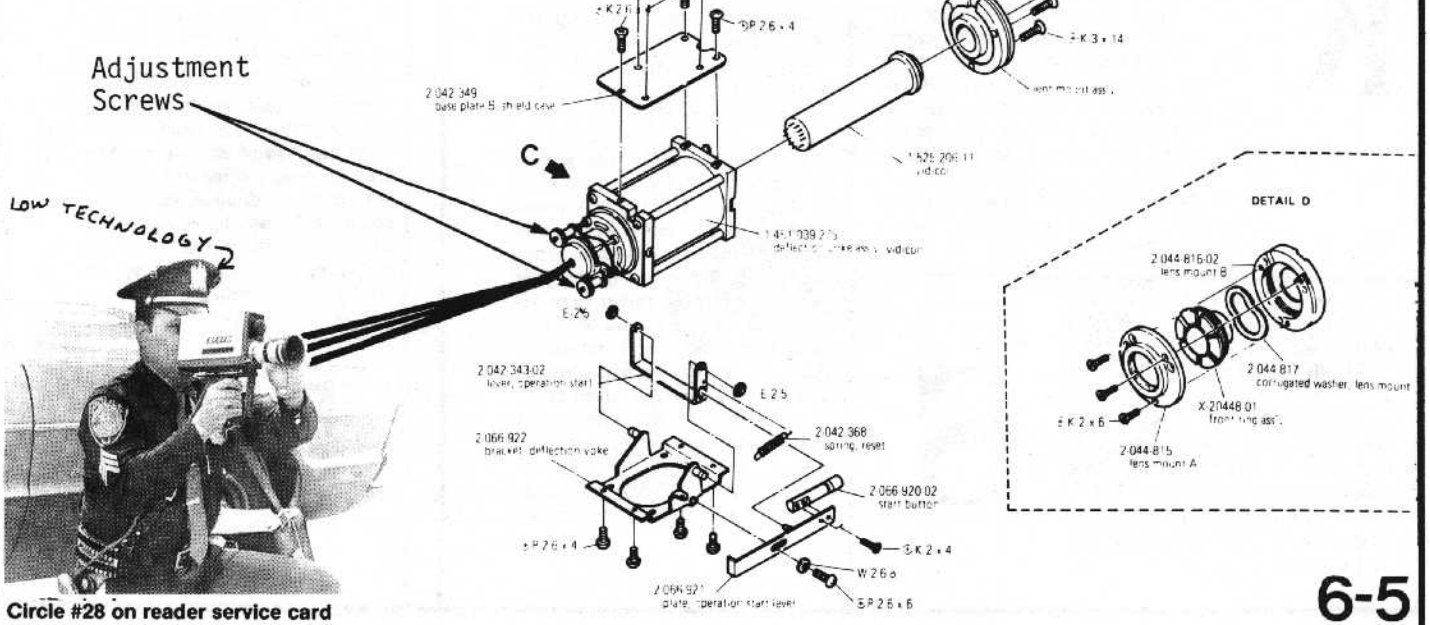

Circle #28 on reader service card

6-5

Planning and Cities, general editor George R. Collins, George Braziller, 10 volumes, paperback \$2.95 each.

Anyone concerned with urban planning, present city design, and an understanding of the social, religious and economic concepts as they've been manifested and have evolved through time to create the modern city of today will find this an exciting, informative and well illustrated series.

The series includes:

Village Planning in the Primitive World by Douglas Fraser

Cities and Planning in the Ancient Near East by Paul Lampl

Urban Planning in Pre-Columbian America by Jorge Hardoy

Medieval Cities by Howard Saalman

The Cities of Ancient Greece and Italy by J. Ward-Perkins

The Renaissance City by Giulio Argan

The Modern City: Planning in the 19th Century by Franco Choay

The Modern City: Planning in the 20th Century by George R. Collins

Military Considerations in City Planning by Horse de la Croix

Socialist Planning in the Cities of Eastern Europe by Branko Maksimovitch

Tony Garnier: The Cite Industrielle by Dora Weibenson

Le Corbusier: The Machine and the Grand Design by Norma Even-son

B

Human Design—molecular, cellular, and systematic physiology by William S. Beck, Harcourt Brace Javanovich, Inc., textbook, hardcover, \$15.95.

This is an excellent basic text for anyone interested in human physiology. The author's approach is interdisciplinary; he deals with physiology in relation to anatomy, histology, biophysiology, genetics and biochemistry. The book is divided into two sections: 1) molecular and cellular physiology, and 2) systems of the body. Illustrations are plentiful.

Diet for a Small Planet, by Frances Moore Lappe, Ballantine Book, 1971. \$1.25.

This is a well-researched book presenting reasons, facts and figures for abandoning a meat diet and comparisons of specific contents of different non-meat foods. It lays out what food combinations supply essential amino acids, vitamins and minerals correlating these with what the author calls net protein utilization of the amount of protein actually available to the body. It also states things like:

"Now let us put these two factors together: the large quantities of humanly edible protein being fed to animals, and their inefficient conversion into protein for human consumption. Some very startling statistics result. If we exclude dairy cows, the average ratio for protein conversion by livestock in North America is 10 to 1. Applying this ratio to the 20 million tons of protein fed to livestock in 1968 in the U.S., we realize that only 10 percent (or 2 million tons) was retrieved as protein for human consumption. Thus, in a single year through this consumption pattern, 18 million tons of protein becomes inaccessible to man. This amount is equivalent to 90 percent of the yearly world protein deficit."

About half of the book is devoted to recipes using the logic of the rest of the book. It's a good reference for the stuff we put in our mouths.

O

Cosmic View—The Universe in 40 Jumps by Kees Boeke, John Day Book, \$4.50 hardcover.

Through a series of 40 illustrations this book takes you on two long journeys: from an object on earth into outer space, and from the same object to the nucleus of the sodium atom. The journey to outer space starts at a point on earth five meters from a young girl sitting in a schoolyard in a town in the Netherlands. In a series of 25 successive drawings, with each successive scale one-tenth of the one before, we go straight up into the sky seeing everything at ever increasing heights and fields. We see Europe, the whole earth, the moon, neighbor planets, the sun, and then beyond to neighbor stars, the milky way, until we leave our own galaxy and see it shrink to a small spot. We are left looking at the specks of infinite universes beyond.

In order to make the second journey, which focuses on the hand of the same girl in the schoolyard through the surface of her skin to the sodium atom, we must arrive back on earth. To do this the scale must be increased rather than decreased, by 10. In a series of 13 successive drawings, still increasing the scale by 10, we pass through skin tissue bacteria, viruses, molecules, X-rays, cosmic rays, to the sodium atom at ten million million magnification (where a man's height drawn to scale would be about the diameter of the solar system.).

One picture is worth 10^3 words.

Black Talk, by Ben Sidran, Holt, Rinehart and Winston, \$5.95. Sidran's thesis is that black culture, based essentially on oral tradition (unlike the predominant western culture based on a linear, literary tradition) has created a context for social interaction, information exchange and communication, leading to an evolution of values and attitudes which have greatly suffused and influenced the culture of young middle class white America—the children of change. Since he is a musician as well as a scholar the book also provides an excellent critique of the history and development of jazz.

Warriors of the Rainbow by William Willoys & Vinson Brown, Naturegraph Co., Healdsburg, Calif.

Strange and prophetic dreams of the Indian Peoples . . . "believing that only God is the Knower. That men should love one another and understand one another is the great message of the visions of Indian peoples, nothing of selfishness nor vanity, nothing of narrowness nor pride." Just as we are re-discovering our natural selves, so too are young Indians of today searching for their meaningful past.

Also: Check out the Penguin Metaphysical Library, edited by Jacob Needleman. At prices of \$2.00 and less it includes: *The Sacred Pipe*—Black Elk's account of the seven rites of the Ogala Sioux; *Born in Tibet* by Chogyam Trungpa; *Alchemy* by Titus Burckhardt; the *Strange Life of Ivan Osokin* by P.D. Ouspensky . . .

K

The Center of the Cyclone, by John Lilly, Julian Press, \$3.95 paperback, \$6.95 hardcover. Lilly is a scientist whose curiosity and research have carried him into realms where the object language of science just isn't applicable. In this book he describes a decade of looking into LSD. With acid, research and experience are the same so that Lilly writes from both the inside and the outside at the same time. At times the old scientist wins out. But even though he's nowhere as lyrical as Carlos Casteneda, by managing to avoid the excesses of Leary and Baba Ram Dass-type writing he's provided some valuable maps of a terrain which is becoming more and more commonplace.

Conscientious Guide to Drug Abuse by Vic Pawlak. A "Do It Now" publication, P.O. Box 3575-C, Hollywood, Calif. 90028.

Honest, straight forward facts on drugs, their effects, over dose potential, addictive qualities, which ones to avoid and what to do in case of bad trips. Any drug user should read this; good also for parents!

S

Guerrilla Television by Michael Shamberg and Raindance Corp., Holt, Rinehart and Winston, \$7.95 hardcover, \$3.95 paperback.

Though the author's style is often blunt and adolescent, he shows brilliance in analysis of the mess into which American Civilization has fallen, contributed to by the crassness of commercial media. The book scans thinking and visions of Americans who have grown up in mediaized America cognizant of its shortcomings and blessings and who continue to search for ways to foster individual expression and creativity in an environment which at present is not acceptant of novel change and innovation. The presentation of some possible solutions to the dilemma of growing frustration in our land is illuminating. This book offers a concise manual for the decentralization and democratization of the video medium.

Television The Business Behind the Box by Les Brown, Harcourt Brace Javanovich, hardcover \$8.95.

This brilliantly written book reveals the personalities, business and programming processes determining the bill of fare of broadcast tv in the USA. This book is a must for people who want to better understand the TV entertainment and information monster. Highest recommendation.

EDUCATION KEY TO THE FUTURE

Woodstock Aquarian

"We'd like to think that everything in this publication is part of a wheel. The content is many faceted . . . like the spokes in a wheel. It all comes together at the hub. The hub is empty. It represents you . . . me . . . us . . . everyone . . . and it. It is your information and your story. Do with it as you will." Meditation, organic food, reincarnation, land info, lists of resources to contact, beautiful pictures, fine graphics, open layouts, a Wonderful fullness.

four issues for \$7.50
Woodstock Aquarian
Box 401
Woodstock, N.Y. 12498

PRINTED ENERGY

Basic Electronics, prepared by Bureau of Naval Personnel, Dover paperback, \$3.50. A comprehensive introduction to the subject with plenty of illustrations and written in plain, concise language.

Picture Bandwidth Compression edited by T.S. Huang and O.J. Tretiak, Gordon and Breach Science Publishers, 1972.

The Television picture can provide a highly efficient medium for print, graphic, and image information distribution of great ecological validity than other media e.g. print on paper, or image on film. (See *Scientific American*, Sept. 1971, "Information and Energy.") The demand for video information transmission will be increasing in the future e.g. picturephone, weather maps, newspapers, etc. This volume comprises the proceedings of the Symposium on Picture Bandwidth Compression at MIT, in April of 1969. It deals with the theory, investigation, and practical application of means of optimization of picture transmission systems.

Special Price for
Radical Software readers:
\$19.50 (regular \$49.00)

Canadian Whole Earth Almanac

One of the most thorough alternate publication/information catalogs we've come across. They choose a theme for an issue such as healing, shelter, etc. and compile as much information from numerous and obscure sources as they can. Not just reviews but commentaries, articles and studies are used to relay the information. After all the heavy print and beautiful graphics at the bottom of the last page appears;



Canadian Whole Earth Bookmobile
Box 6
341 Bloor Street West
Toronto 181, Canada

Physics and Beyond: Encounters and Conversations, by Werner Heisenberg, Harper and Row, \$5.95. These are Heisenberg's memoirs written in a clean, descriptive fashion. He alternates chapters on physics, aesthetics, epistemology, and history of what it was like to be a (genius) physicist during this century. Old Heisenberg knew everyone, of course.

Because Heisenberg integrates his physics into all the other things going on at the time, and because the chapters on physics are an excellent layman's introduction to the subject, this is an immensely valuable book. While the place to be now (in science) is probably biology, at the turn of the century it was physics (and just as biological models and metaphors dominate our thinking now, the tools of physics were what mattered most then) and Heisenberg helped make it happen. No uncertainty here.

Puget Sound Access

"A Part of the Earth Catalog"

Hopefully there will be more publications like this one. It's of Whole Earth Catalog size and is the same idea but on a local level (Puget Sound). Containing a full gamut of survival information for neither the whole earth nor the neighborhood but for a regional area.

\$1.50 per issue
Puget Sound Access
P.O. Box 15301
Wedgewood Station
Seattle, Wash. 98115

Natural Life Styles

Just love these family group publications. An organic guide for living with a heavy emphasis on good food for your earthly body. They go into sources of food, new ways of avoiding the polluted stuff handed us in those brightly colored packages. Also talks about other aspects of body-world like acupuncture, bee hives and kilns.

Natural Life Styles
5-c Tillson Road
Tillson, N.Y. 12486

Holt Paperback \$3.95

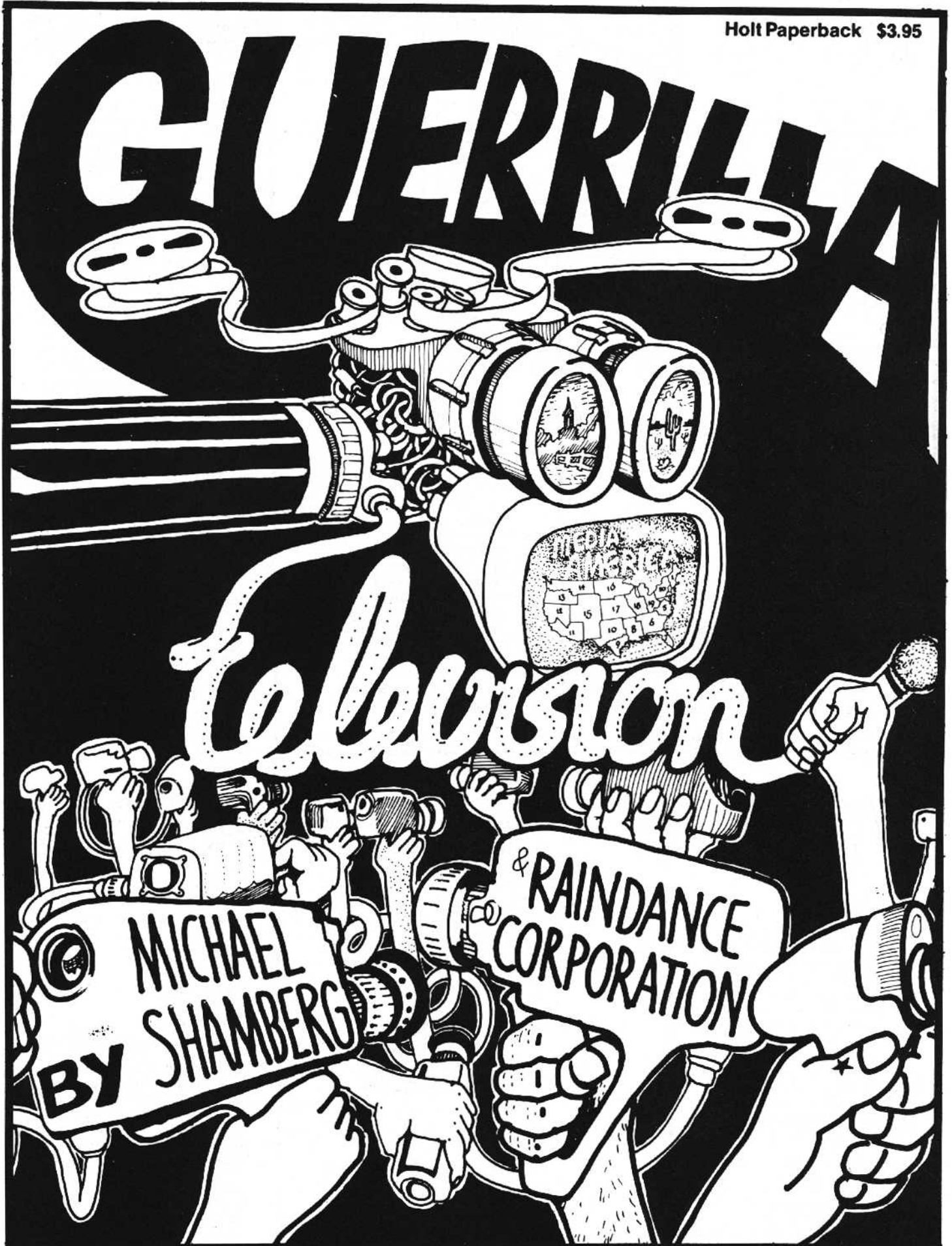

GUERRILLA TV is a manual of the hardware, software and metaphysics of alternate television and a journal of our experiences doing it. At bookstores from Holt, Rinehart and Winston.

Radical Software VOLUME TWO



NINE ISSUES



Alternate cultures need alternate technologies (and alternate technologies generate alternate cultures). One of the first technologies to have been redesigned for high access was television, and that's how **Radical Software** began, as a journal of alternate TV.

But we've also dealt with other environments which shape our lives: architecture, computers, new materials and processes, medicine, cybernetics (and its metaphysics), the biosphere . . .

Changing Channels, we expect that the future volume of **Radical Software** will continue the process of communication and access (putting people and projects in touch with one another, telling where to get what) into many areas other than video.

Our plan is to give some issues over to other groups and provide them with a production budget so they can generate their own information.

To do this, we've decided that the next volume will be nine issues appearing over a year's time (January-February, March, April, May, June-July, August, September, October,

and November-December) in a nine by 12 inch format—beginning in September.

Single copies will cost \$1.95 through bookstores and newsstands. But naturally we're offering a subscription price, which is \$12.50 for all nine issues, or a savings of \$5.05* (Prepaid subscriptions will enable us to budget for future information probes).

*Single copies will be available only through bookstores and newsstands. If you'd like to carry **Radical Software** in your bookstore and aren't now doing so, write us at the address below.

BEGINNING SEPTEMBER 1972

RADICAL SOFTWARE: Suite 1304, 440 Park Avenue South, New York, New York 10016

Please enter my subscription for volume two of **Radical Software** to begin in September of 1972. Enclosed is \$12.50 for all nine issues (a savings of \$5.05).

NAME _____

ADDRESS _____ CITY _____

STATE _____ ZIP _____

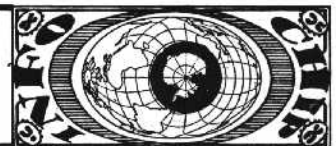

Radical Software VOLUME ONE

BACK ISSUES

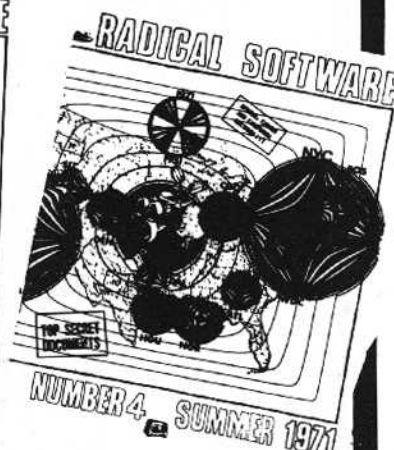
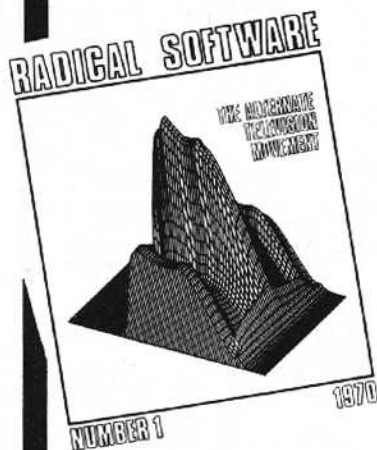

THE COMPLETE SET OF ISSUES 1-4

AND/OR

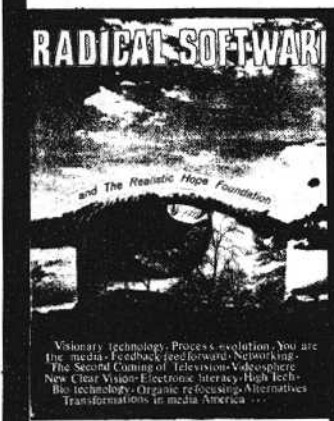

We get a lot of orders for back issues of **Radical Software** because as a set they are a good overview and introduction to the whole notion of alternate technologies for alternate cultures. In fact, we've had to reprint several of the issues.

Now, we've reprinted again and can sell full sets, including the previously out-of-print first issue. (Issue five is the one you're reading, and can be ordered separately. Issue six is the book, **Guerrilla Television**, published by Holt, Rinehart and Winston, which can also be ordered separately).

To do this, we've set a standard price of \$3.00 apiece for issues one through four, but are offering the complete set at a discount price of \$10.95, which will include a binder. We will also continue to supply bookstores provided they order a minimum of ten copies per issue.*

* Does not include **Guerrilla Television** which can be ordered through regular distributors.

AND/OR



RADICAL SOFTWARE: Suite 1304, 440 Park Avenue South, New York, New York 10016

Please send me the following back issues of **Radical Software:**

___ sets of issues 1-4 in a binder (@\$10.95) Enclosed is \$ _____

___ copies of issue one (@\$3.00) Enclosed is \$ _____

___ copies of issue two (@\$3.00) Enclosed is \$ _____

___ copies of issue three (@\$3.00) Enclosed is \$ _____

___ copies of issue four (@\$3.00) Enclosed is \$ _____

___ copies of this issue—number five (@\$3.00) Enclosed is \$ _____

___ copies of **Guerrilla Television** (@\$3.95) Enclosed is \$ _____

TOTAL MONEY ENCLOSED \$ _____

NAME _____ ADDRESS _____

CITY _____ STATE _____ ZIP _____

Science

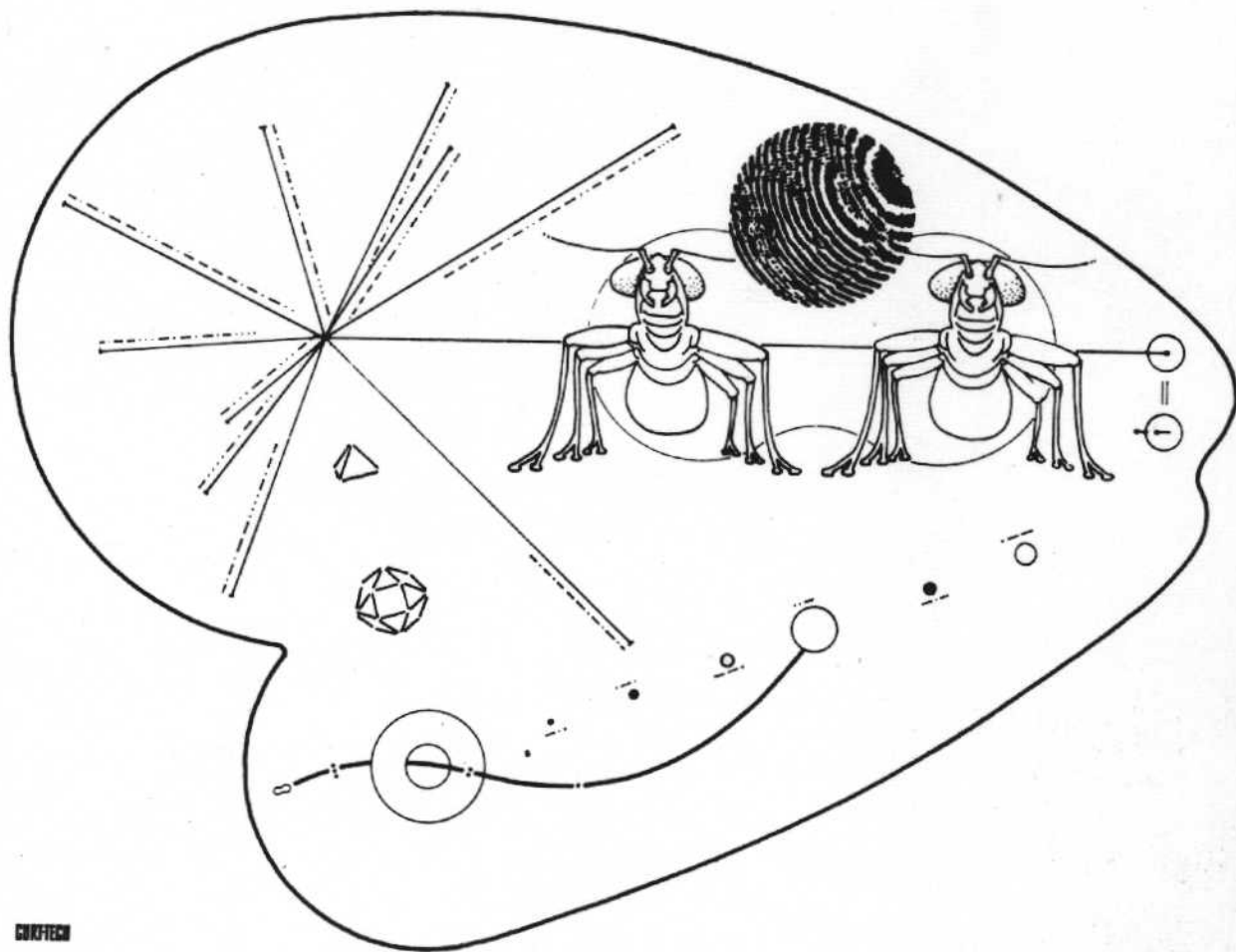

CORFIELD

To Let Others Know We Are Here

Tonight, if all goes well, the United States will launch the longest space mission in history. Its primary goal is to send back to earth, some two years hence, close-up pictures and scientific observations of Jupiter, largest planet of the solar system. But a more exciting—albeit uncertain—mission is to announce to some distant civilization that we are here. It is the first official effort on the part of mankind to draw attention to itself. As the vehicle, Pioneer 10, passes Jupiter, the gravity of that planet will seize it and hurl it out of the solar system. It will sail indefinitely through the vast reaches of the Milky Way Galaxy, carrying a message (reproduced above) in the form of a gold-coated aluminum plate, for any members of other planetary civilizations who may happen to encounter it. Scientists agree, however, that the chances are very slim indeed.

The message is designed to be decipherable to any scientist, regardless of his physiognomy, history or location in space and time. The symbol, upper left, draws attention to the two states of the hydrogen atom as the unit of time (radio frequency) and distance (wavelength) to be

used. The star-like diagram shows the position of the earth relative to 14 pulsars. These are stars that emit radio pulses at regular (though in some cases slowly changing) rhythms. Solid lines indicate the relative distances of these pulsars. The dashed extensions of these lines are marked with tics indicating the rate at which that pulsar is pulsing. The rate could be used to identify each pulsar, much as each lighthouse has its characteristic rhythm. Since a few pulsars are slowing their rate, the message also indicates roughly the time of launch.

The long horizontal line extending to the right behind the two figures indicates the direction to the center of the Milky Way Galaxy. The figures stand in front of a schematic diagram of the spacecraft with its dish-shaped antenna to give an idea of the dimensions and appearance of earth's inhabitants. The man's hand is raised in friendly salute. Below is a representation of the solar system with the sun at the left, showing that Pioneer 10 was launched from the third planet out from the sun and then was thrown out of the system by Jupiter's gravity.

—WALTER SULLIVAN

RAINDANCE VIDEO

Over the past three years we've compiled many hundreds of hours of videotape, some of it edited, much of it unedited. And we continue to make videotape, of ourselves, our environment, our friends; other environments, other cultures, other events.

During the past year the volume of videotapes we've sent out has increased substantially through both sales and exchange. Moreover, we are increasing our commitment to producing alternate video information.

Thus, we're offering three ways to get Raindance videotape:

1. *The Best of the Raindance Cultural Data Bank*: We began taping when portable video equipment first appeared almost four years ago. Our archive (cultural data bank) thus encompasses many facets of alternate television from historical events like New York's East Village at its prime in 1968, Woodstock, Altamont; through an exploration of many of the different genre of alternate television (street video, life style video, political demonstrations, documentary, and so on); to an exploration of what makes video a unique medium (feedback, time-delays, synthesized imagery).

We will sell a 10-hour package of this material for either personal or educational use as a reference library. Our price is \$500 for the series, video tape included.

2. *The Raindance VideoLog*. In addition to making available tape from the past, we want to establish a regular distribution channel for our current work. *The Raindance VideoLog* will be a bi-monthly assemblage of tightly edited segments by ourselves and others offering access to up-to-date activity in alternate television. The first issue will include videotape from Vietnam, humor, life style video, and video imagery.

We will distribute this in any format a subscriber wants, including videocassettes. For a year's subscription (six issues) the price will be \$250, videotape included (write for videocassette format prices as we don't yet know what the raw stock price will be). Single issues also available at \$55 an hour, tape included.

3. *Videotape Exchange*: Probably the most satisfying mode of distribution we've yet found is exchanging videotapes. We're averaging about eight exchanges a month and it really seems worth it.

The offer is this: You send us some of your software, and we'll send back an equal amount of ours (for non-commercial use).

Contact: RAINDANCE VIDEO SERVICE, Post Office Box 543, Cooper Station, New York, New York 10003; or call (212) MU-7-4210.

