

  
*Kitch Kees*  
FAMILY DANITY

**RADICAL  
SOFTWARE**  
volume II number 5

# video and environment

SUPPORTED BY THE NEW YORK STATE COUNCIL ON THE ARTS

Editors in Chief: Beryl Korot and Ira Schneider

Address all editorial correspondence, as well as correspondence to Raindance Foundation, to POB 135, Ruby, N.Y. 12475.

**Publishers:** Gordon and Breach, Science Publishers, Inc., One Park Avenue, New York, N.Y. 10016. Application to mail at second class postage rates is pending at Long Island City, New York. Copyright © 1973 by RAINDANCE FOUNDATION. Subscription rates (Volume 2, 9 issues)—*United States/Canada: Individuals, \$12.50; Libraries and Institutions, \$45.00. Great Britain/Elsewhere: Individuals, £6.67/\$16.00; Libraries and Institutions, £20.20/\$48.50.* Published monthly with the exception of July, September, and December. Single copies \$1.95; back issues, \$3.00. No part of this periodical may be reproduced without the written permission of the publisher. Printed in the United States of America.

Address all Radical Software subscription, circulation, and distribution correspondence to Gordon and Breach Science Publishers, One Park Ave., New York City, N.Y. 10016.

This issue is brought to you by:

JUAN DOWNEY

FRANK GILLETTE

BERYL KOROT

IRA SCHNEIDER

It presents: *diagrams, drawings, photographs, explanations of a variety of video performances, environments, exhibitions*; it contains articles on *domestic communications satellites, computer gaming, Euclidean Space, theatrical experiments*; it includes an updating of the *RS worldwide videotape directory, a vt program guide, a video tools report*. And more . . . .



Thank you: Marilise Downey for helping out with production; also Titi and Juanfi LaMadrid, Andy Mann, and Barbara Goldberg for joining us on those few long week-ends; and to Schneider for the feasts.

# TECHNOLOGY

Wars against humanity and nature (i.e.—the violent extraction of the earth's fruits) have been technology's *raison d'être* and the incentive for its urgent development. Misapplied technology generates apparent wealth, but in the process disharmonizes the interaction between humanity and nature.

The overwhelming progress of industrialization is attributable to the mass-production of successful objects: the same form repeated for everybody. This ideal is contemporary with the emergence of socialism. But assembly lines and consequently series of identical forms are alien within a natural context.

Industrialization is also anti-natural as it displaces nature's mystical import, with its mechanistic myths, truncating man from nature.

Nineteenth century industrialization sought to replace and control natural effects, thus creating cultures with rigid, overspecialized and fragmented roots: millions of disconnected individuals. Cities have become monuments to the mass marketing of objects, with the consequent glorification of transportation systems, the most common and obvious source of ecological breakdown. Transportation systems are the web of centralized imperialistic greed. The price of sustenance for these networks of exchange has also culminated in worldwide political madness.

Today we seek to organize ourselves around cybernetic communication systems and energy sources developed by the World War II generation and, until the present, utilized exclusively with a nineteenth-century-object-marketing attitude. It is this industrial use of technology as opposed to the cybernetic use of technology which produced a culture aborting *both* humanism and mysticism.

Cybernetic technology operating in synchrony with our nervous systems is the alternative life for a disoriented humanity. Electronics inevitably stretching the human nervous system reshapes the manner in which we occupy environment. By expanding our perception, electronic circuits strengthen the man-space relationship, rendering apparent its dependency upon time . . . Our lifestyles require a larger and more energized environment. The way we relate to other humans creates unprecedented intra and inter-urban groupings, organic to communication systems.

Ironically, the man-nature chasm can only be closed by technology. The process of reweaving ourselves into natural energy patterns is *Invisible Architecture*, an attitude of total communication within which ultra-developed minds will be telepathically cellular to an electromagnetic whole.

While industrialization terminated the notion of a diversified hand-made environment, computer technology opens to diversification in environmental design. It can alter modular units (non mass-production) to create systems of higher complexity and flexibility where the potentialities of human communities, due to the nature of their brains, are higher. This is a post-political, erotic, mystic, electromagnetic, level of reality. Computers, by transforming the environment into cells of varied shapes integral to a synergistic whole, will introduce a mystical humanism. In some human beings, brain waves are symbiotic with natural phenomena: communication with others and with the environment is total.

The invisible architect becomes one with energy and manipulates this wave-material. *Invisible Architecture* re-explains electronic circuitry as a bio-feedback tool in evolving the collectivity of human brains to transmit and receive (non-verbally) high frequency electromagnetic energy. Direct communication is beyond symbols: the content overpowers the significant.

Human/ electronics interaction sets humanity on a global, interconnective level where technology becomes less and less necessary . . . Cybernetic technology breaks through the impasse to which the pre-cybernetic use of technology brought us to; ecological balance threatened by an endlessly increasing number of tools.

Industrialization/ transportation

*Invisible Architecture* provides shelter and communication/ transportation systems generated by the electromagnetic and gravitational energy exchange.

(The universal law of gravitation can be understood not as a vertical pull, but as a tensional system sustaining the distances between bodies and their orbital cycles).

#### THE DEMATERIALIZED CITY

First Stage: Electronics reshape macro-planning. Second Stage: A communication network.

"The emergence of monotheism had as its corollary the rejection of Nature; the affirmation of Jehova, the God in whose image man was made, was also a declaration of war on Nature." *Design with Nature*, by Ian McHarg.

The judeo-christian tradition processed for several millenia an anthropocentric reasoning that culminates in the renaissance, declaring inferior any art created outside southern Europe. The evolution of this geo-political arrogance is the narrow-minded, imperialist conception of the *primitive* and the *exotic*. Racism applied to art is cultural suicide as well as homicide.

#### FIRST STAGE: ELECTRONICS RESHAPE MACRO-PLANNING.

The dematerialized city as a matrix of communication/ energy exchange/ transportation:

Urban services, such as education, entertainment, work, shopping, mass-eroticism, debris disposal and stock-marketing, are pre-empted by a multi-directional video computer network, which allows human beings to re-establish their relationship with nature. The option of a rural life for anybody with the advantages of urban stimulus. Cybernetic electronics raises society to an energy realm increasingly connective with whatever makes the Universe work. Fuller terms this process *synergy* and Teilhard de Chardin poetizes *for everything that rises must converge*. A society dedicated to the cultivation and enjoyment of the earth is a reality through the medium of electronic technology.

#### SECOND STAGE: A COMMUNICATION NETWORK.

Within a setting where the ultimate value is an integration with natural forces, Western Culture (in spite and due to an advanced technology) ranks low when compared to Egypt, the Mayans, China, Tiahuanaco or other so called *primitive cultures*. What we underestimated as *religious* or *magic*, has proven to be knowledge of a more encompassing physical reality. Western conceptions of the *primitive* and the *superstitious* are often sophisticated and complex interactions acting upon environment.

The Dematerialized City is the electronic communication's network, the neural circuit that binds individual selves despite distance, thus providing an understanding of relativistic space-time. Teilhard de Chardin describes the future humanity as a *socialization of the mind*; and Paolo Soleri defines the city as a *thousand minds*. I define the Dematerialized City as *that group of minds neurally connected to me*. The structure of our city is the means of communication that maintains our unity. My family in Chile is part of this invisible city when we speak by phone via Telestar. Thus, the satellite and its orbit around the earth exist as a living neural cell.

An understanding of energy and matter elevates humanity to operational level within the spectrum of electromagnetic energy.

I conceive of a future, without a technological crutch, in which ultra developed human brains are deeply woven into the energy paths and patterns to an extent where disorder, war, waste and crime are out of context. Human beings would share with all other species the benefits of natural cycles: communicant balance.

A  
N  
D  
  
B  
E  
Y  
O  
N  
D

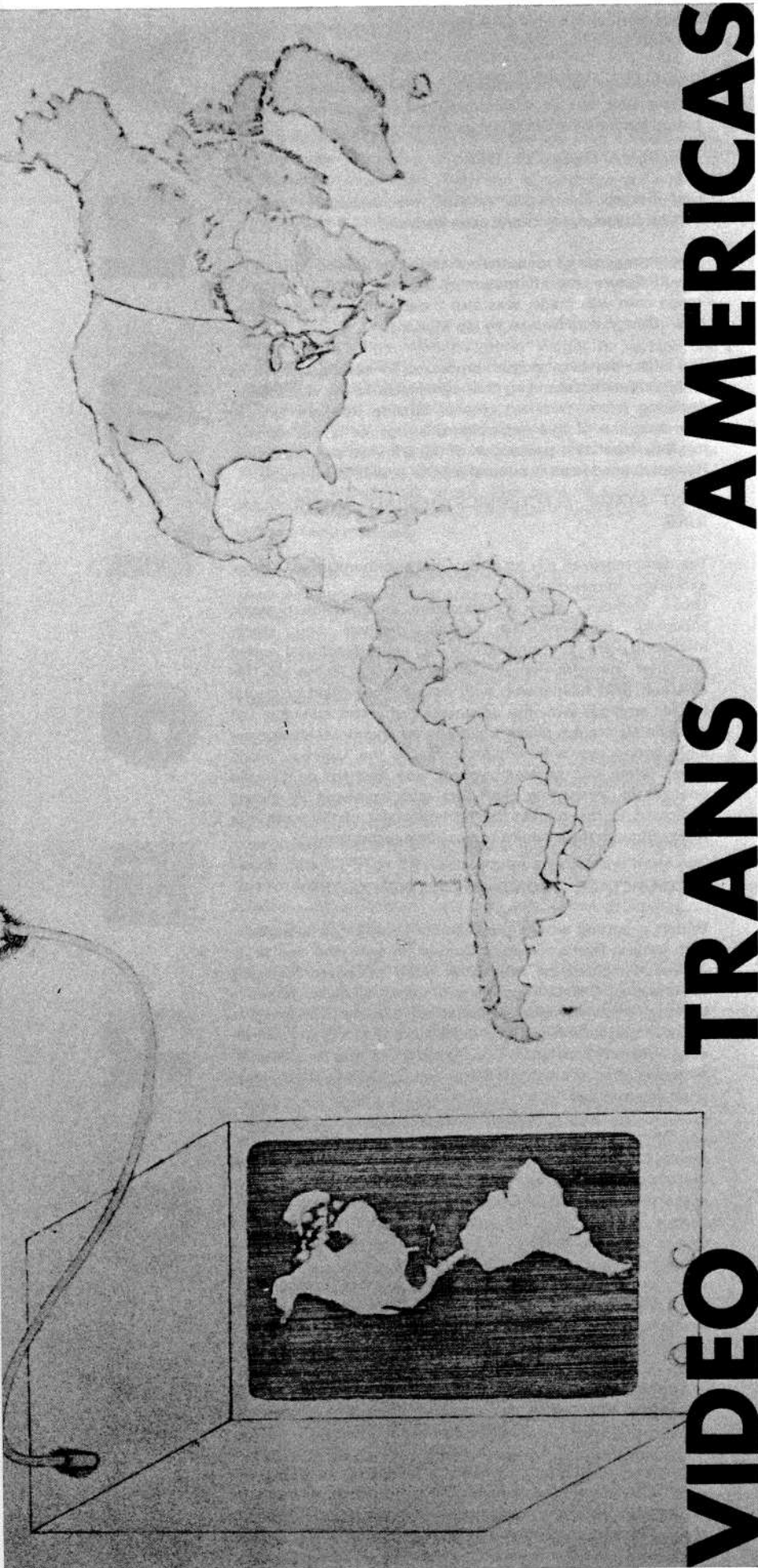

Many of America's cultures exist today in total isolation, unaware of their overall variety and of commonly shared myths. This automobile trip is designed to develop a holistic perspective among the various populations inhabiting the American continents, thus generating cultural interaction.

A videotaped account from New York to the southern tip of Latin America. A form of infolding in space while evolving in time. Playing back a culture in the context of another, the culture itself in its own context, and, finally, editing all the interactions of time, space and context into one work of art.

Cultural information (art, architecture, cooking, dance, landscape, language, etc.) will be mainly exchanged by means of video-tape shot along the way and played back in the different villages, for the people to see others and themselves.

The role of the artist is here conceived as a cultural communicant, as an activating aesthetic anthropologist with visual means of expression: video-tape.

The expedition will leave in July and return to New York in early September, where the video-tapes will be edited and presented in final version.

Juan Downey

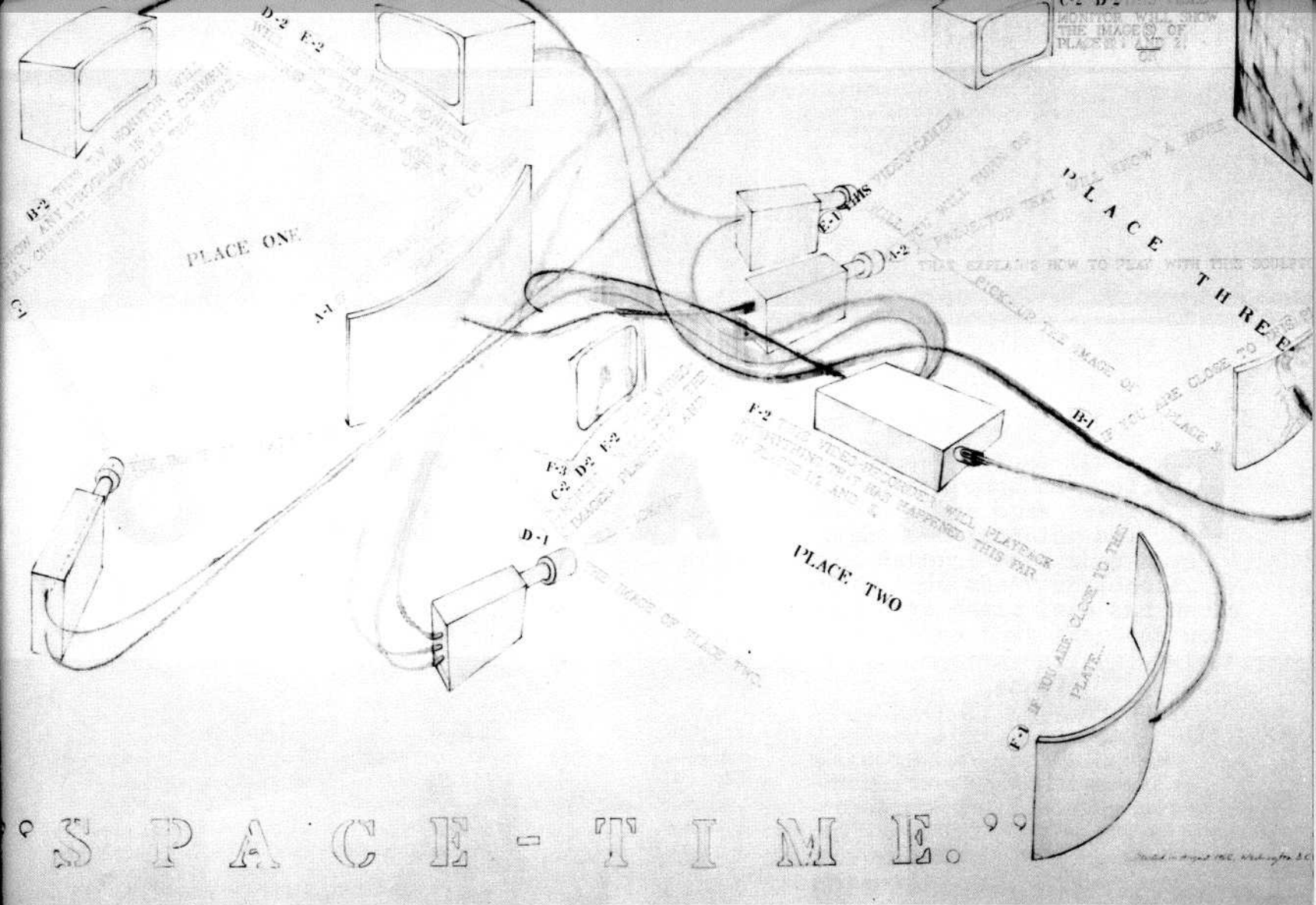

Project for the Juan Downey exhibition at the Corcoran Gallery of Art Washington D.C. 1968.

# 3 way communication

Three performers sit at the corners of a large triangle formed by three voice--transmission laser beams. The performers exchange faces by means of super-8-movie projections while talking through the laser beams. Conversations and transfigurations are video-taped and played-back once the three performers leave.

Central Michigan University, 1972  
 New York Avant-Garde Festival, 1972  
 Everson Museum of Art, Syracuse, N.Y., 1973

Juan Downey

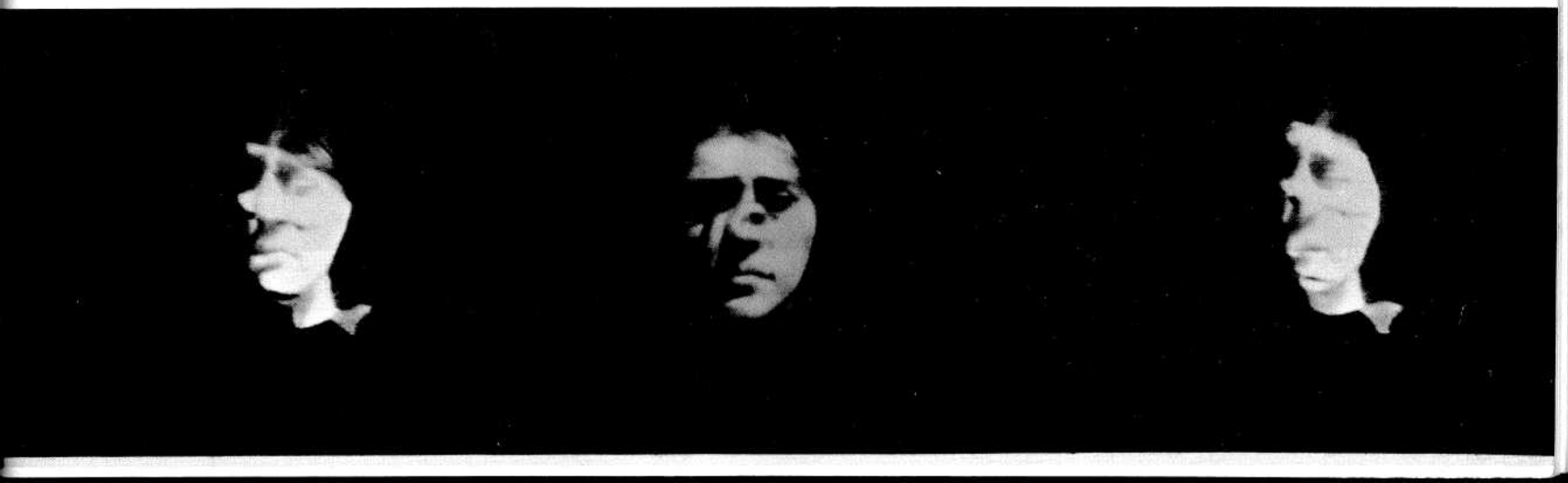



# P L A T O







# N O W

by Juan Downey

Nine performers in meditation attempt to produce alpha-waves. Their brain activity controls the recurrence of pre-recorded quotations from Plato's dialogues.

9 performers/9 video-channels/  
alpha-wave detectors/9 audio-  
recordings/public's shadows.  
Everson Museum of Art, Syracuse,  
New York, 1973.

Plato's dialogues researched  
in collaboration with Jerry  
Bowen.

...human beings living in an underground cavern, which has a mouth open towards the light and reaching all along the cavern; here they have been from their childhood, and have their legs and necks chained so that they can not move, and can only see before them, being prevented by the chains from turning round their heads. Above and behind them a fire is blazing at a distance, and between the fire and the prisoners there is a raised way; and you will see, if you look, a low wall built along the way, like the screen which marionette players have in front of them, over which they show the puppets.

I see.

And you see, men passing along the wall carrying all sorts of vessels, and statues and figures of animals made of wood and stone and various materials, which appear over the wall? Some of them are talking others silent.

You have shown me a strange image, and they are strange prisoners.

Like ourselves, and they see only their shadows, or the shadows of one another, which the fire throws on the opposite wall of the cave?

True how could they see anything but the shadows if they were never allowed to move their heads?

And the objects which are being carried in like manner they would only see the shadows?

Plato: The Republic

For the world is a visible living creature, it contains all creatures that are visible and is itself an image of the intelligible. Plato: Timaeus

Stranger: Ourselves, I take it, and all other living creatures and the elements of natural things--fire, water, and their kindred--are all originals, the offspring, as we are well assured, of divine workmanship. Is it not so?

Theaetetus: Yes.

Stranger: And every one of these products is attended by images which are not the actual thing, and which also owe their existence to divine contrivance.

Theaetetus: You mean...?

Stranger: Dream images, and in daylight all those naturally produced semblances which we call 'shadow' when dark patches interrupt the light, or a 'reflection' when the light belonging to the eye meets and coalesces with the light belonging to something else on a bright and smooth surface and produces a form yielding a perception that is the reverse of the ordinary direct view.

Theaetetus: There are, indeed, these two products of divine workmanship--the original and the image that in every case accompanies it.

Plato: Theaetetus

The same argument applies to the natural receptacle of all bodies. It can always be called the same because it never alters its characteristics. For it continues to receive all things, and never itself takes a permanent impress from any of the things that enter it; it is a kind of neutral plastic material on which changing impressions are stamped by the things that enter it, making it appear different at different times. And the things which pass in and out of it are copies of the eternal realities, whose form they take in a wonderful way that is hard to describe.

Plato: Timaeus

There exists, first, the unchanging form entering no combination, but visible and imperceptible by any sense the object of thought: second, that which bears the same name as the form and resembles it, but is sensible and has come into existence, is in constant motion, comes into existence in and vanishes from a particular place, and is apprehended by opinion with the aid of sensation. Plato: Timaeus

And because of this dream state we are not awake to the distinctions we have drawn and others akin to them, and fail to state the truth about the true and unsleeping reality: namely that whereas an image, the terms of whose existence are outside its control in that it is always a moving shadow of something else, needs to come into existence in something else if it is to claim some degree of reality. Plato: Timaeus

Therefore we must not call the mother and receptacle of visible and sensible things either earth or air or fire or water, not yet any of their compounds or components; but we shall not be wrong if we describe it as invisible and formless. Plato: Timaeus

For the only existing thing capable of intelligence we must call soul, and soul is invisible, whereas fire, water, earth, and air all are visible bodies. Timaeus

From which again it follows that the world is a likeness of something else.

Plato: Timaeus

Audio/video engineering in both performances, "Plato Now" and "Three-way Communication by Light" by Andy Mann.

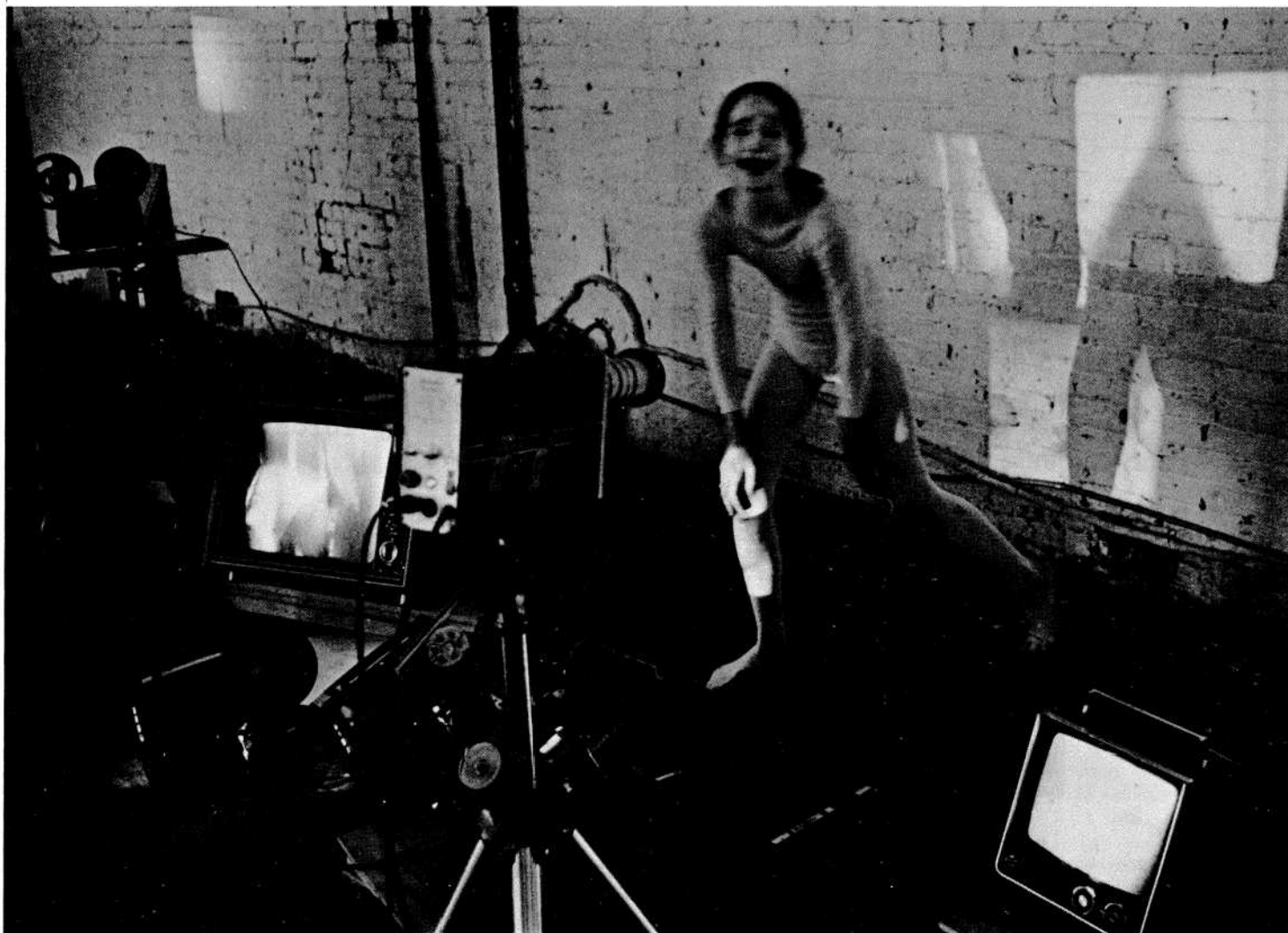

"TERNARY TRANSFIGURAT" Juan Downey. Titi video-performs at 405 E. 13th St., New York, May, 1973.

"COMMUNICATION" by Juan Downey. Phone calls and mailed posters inviting hundreds of people to participate in this event.

For one night, a communication center is established.

The audience is provided with walkie-talkies, closed-circuit TV, telegraphs, intercom radio system, paper and pencils.

A tape is played, for the public to take notes. Then they leave the building; travel, by any means, as far as they can and communicate back to the center whatever they understood of the tape.

At the center, while a live rock-band plays during the night, messages are received, typed and placed over a large map of the area.

Once their messages have been delivered, the audience gradually returns to the center. Near dawn, the original tape is played again. This time, the participants are outside around the pile of burning messages and map. In silence, they listen and look until there is no sound or light.

Smithsonian Institution, Washington D.C. 1968.



"LIFE CYCLE" by Juan Downey. Soil + Water + Air + Light = Flowers. Flowers + Bees = Honey. C.C.T.V. environment. Electric Gallery Toronto, Canada, 1971  
 Everson Museum of Art Syracuse, N.Y., 1971



QUESTION: "WHOM WOULD YOU GIVE MORE POWER TO IN THE ART MUSEUM STRUCTURES?"

"RESEARCH ON THE ART WORLD" by Juan Downey. On January 1970, seven hundred questionnaires were mailed to artists, collectors, and critics. Their answers were computed, rendered into graphics and displayed by electronic means. Howard Wise Gallery, N.Y. Lunn Gallery, Wash. D.C., Electric Gallery, Toronto, Canada.



"INVISIBLE ENERGY DICTATES A DANCE CONCERT" by Juan Downey. Cinemateque, New York, 1970.  
 Dancer Graciela Figueroa stores combinations of habitual movements dictated to her through a C.C.T.V. monitor by six other performers. The performers move in response to the level of radiation, heat, humidity, radio-waves, and light imminent in the environment.

6 FIBERGLASS ROOF PANELS WITH DRAINS FOR ONE MODULAR UNIT

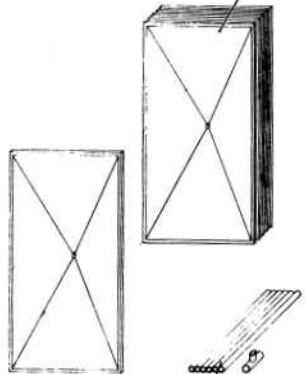

PLASTIC DRAIN TUBES FOR ROOF PANELS

0 5 FT.

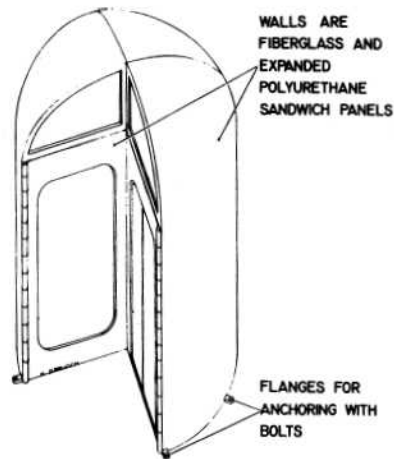

WALLS ARE FIBERGLASS AND EXPANDED POLYURETHANE SANDWICH PANELS

FLANGES FOR ANCHORING WITH BOLTS

ISOMETRIC VIEW OF ONE CLOSED MODULAR UNIT READY FOR TRANSPORT BY TRUCK

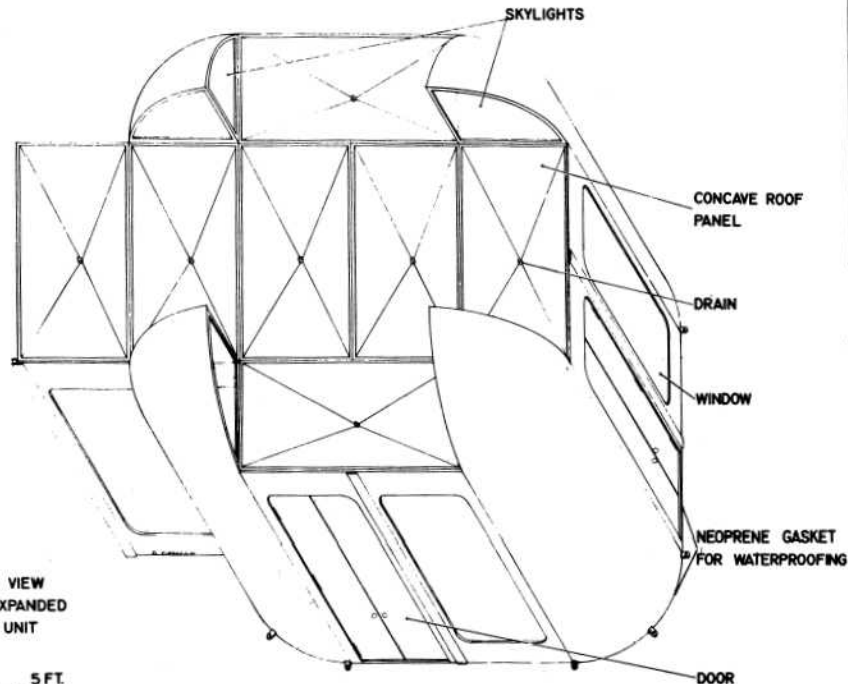

EXTERIOR ISOMETRIC VIEW OF ONE EXPANDED MODULAR UNIT

0 5 FT.

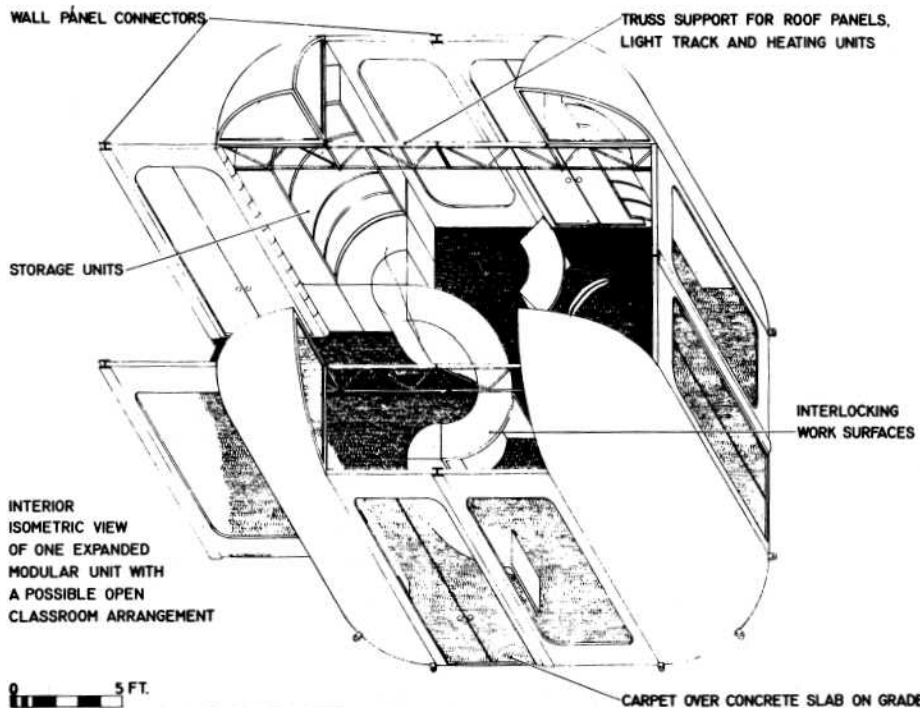

INTERIOR ISOMETRIC VIEW OF ONE EXPANDED MODULAR UNIT WITH A POSSIBLE OPEN CLASSROOM ARRANGEMENT

0 5 FT.

**A MODULAR PREFABRICATED SCHOOL FOR THE ERA OF COMMUNICATIONS**  
 DESIGNED BY: WALTER ZUPANCICH,  
 SCHOOL OF ARCHITECTURE, PRATT INSTITUTE

EACH MODULE IS EQUIPED TO ACCOMMODATE AT LEAST 15 PUPILS AND THEIR INSTRUCTOR. THESE MODULES CAN BE DEPLOYED WITH MINIMAL EFFORT AND TIME WHEREVER AND WHENEVER NEEDED. THEY ALSO HAVE THE CAPABILITY OF INTERLOCKING WITH EACH OTHER, THEREFORE, CREATING A LARGE VARIETY OF SIZES DICTATED BY THE SPECIFIC NEEDS OF EACH COMMUNITY. IN ADDITION EACH MODULE HAS BEEN DESIGNED TO RECEIVE PREFABRICATED TOILET FACILITIES, OFFICES, AND ELECTRONIC DATA RETRIEVAL AND STORAGE BANKS

# THE INFINITY CHAMBER

A corridor is constructed with 17 inch monitors inset into the walls four feet eight inches above the floor. The 27 screens in the outerwall face inward and the 17 screens in the innerwall face outward. A four foot eight inch opening in the outerwall serves as both entrance and exit. The corridor approximates as a rectangular shape. A large arrow outside the corridor indicates that the entrants are to proceed in a counter clockwise direction.

Three varieties of programming are presented on the monitors. Pulsing kinetic abstract images are presented on 12 monitors throughout the corridor. Two channels of prerecorded informational videotape loops are presented on 3 monitors each, distributed throughout the corridor. Three live camera images are selected from 4 low-light sensitive cameras connected to a special effects generator; these and 2 time delay images are distributed to the remaining 26 monitors. A switcher permits the output of any camera or the S.E.G. to serve as an input to the time delay unit. Further, when the fourth camera above is trained on an output monitor of the time delay and its signal dissolved with any of the camera images (by means of the special effects generator) an infinity loop is created. If the special effects generator has genlock capability the infinity loop effect can be extended and multiple images can be incorporated into the infinity loop.

Thus, in addition to seeing one's own image live on tv juxtaposed with pulsating abstracts and collaged information images, one can see one's image repeatedly introduced and gradually fading out as the old images disintegrate, and new images from progressive points along the corridor supplant these eventually to dissolve away themselves. As one proceeds through the corridor a subtle intermix of disorientation and reorientation is intended to occur. As one approaches the exit the appearance of camera, time delay, and infinity loop images decrease as informational and finally abstracts become prevalent.

The diagrams which follow provide the basic plans (the configuration of hardware and outline of operations) for the infinity chamber.

*Note: Care must be taken in selecting lenses of proper focal length to achieve the optimal effect. The pulsing abstracts intended are best generated by the mixing of 2 video feedback loops from high resolution cameras through a special effects generator. Pre-taped abstracts may be used, and suggestions of real images may be introduced in positive, negative, and/or high contrast by means of an S.E.G.*

Ira Schneider  
1970

..... a system of sensors in the corridor and a signal light at the entrance can insure that individuals (or groups) in the corridor are undisturbed by new entrants until they approach the exit. 1 2 3 4 5 ...

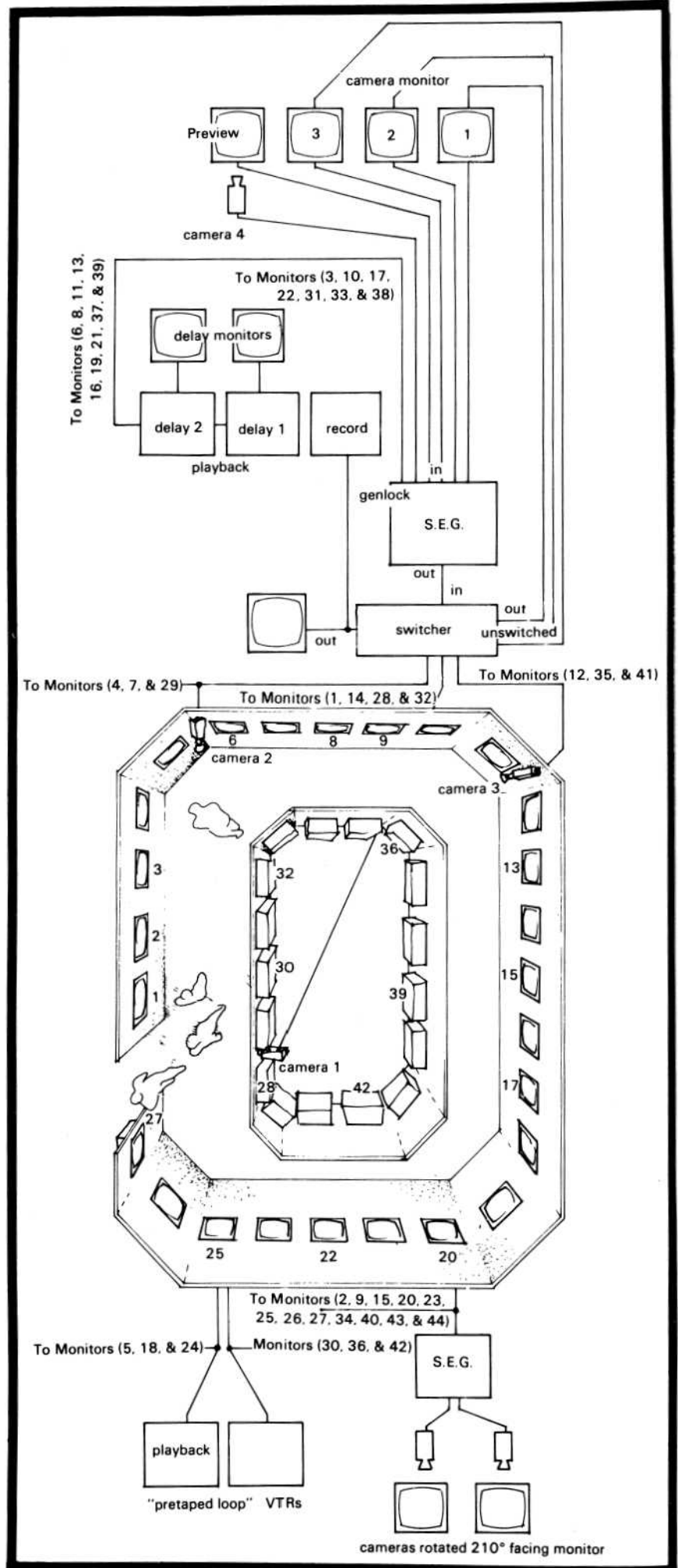

Drafted by Uri Shiran

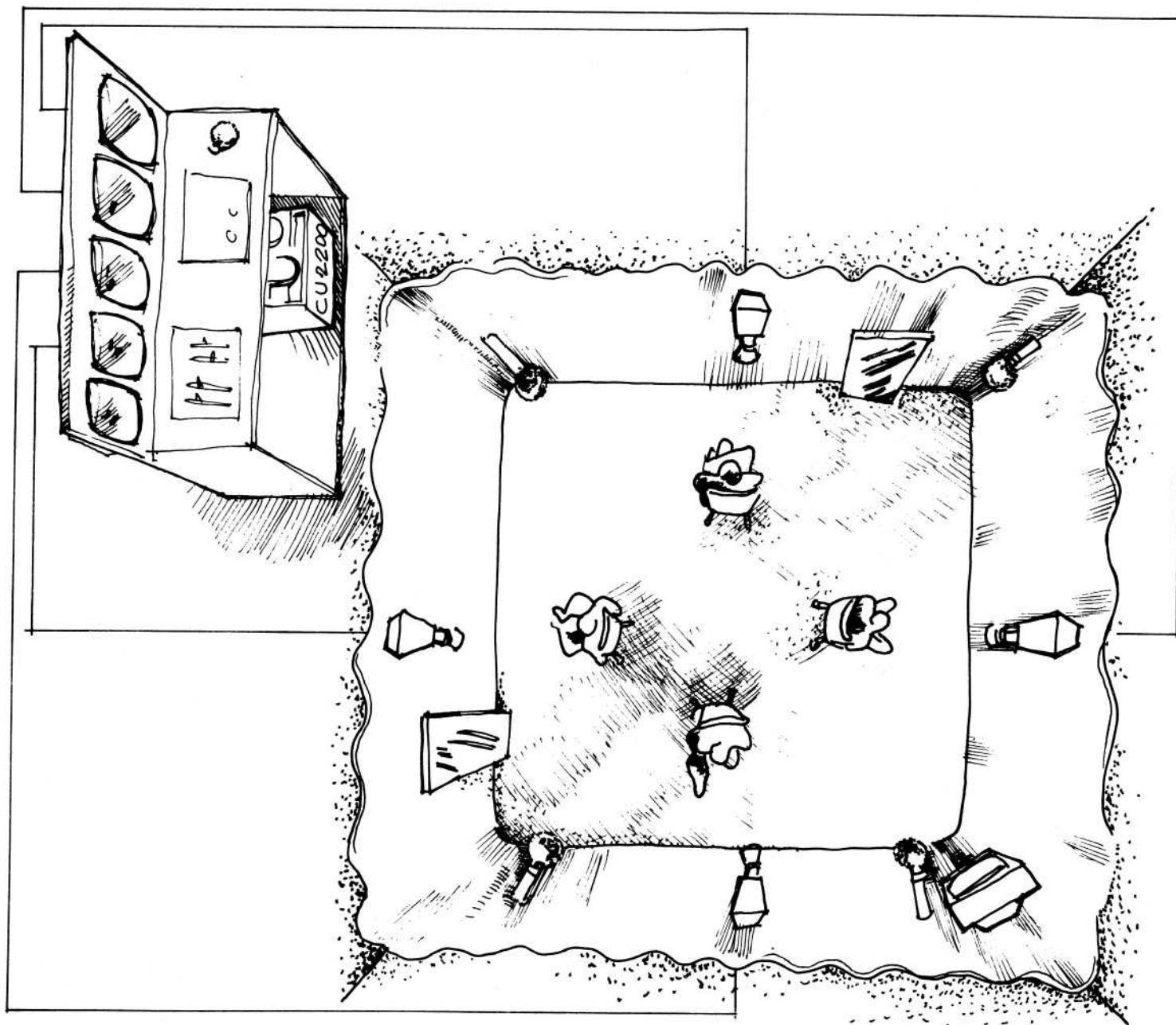

# AN INTERACTIVE EXPERIMENT

In a room 20 feet by 20 feet equipped with four remotely operated auto-focus, auto-zoom video cameras, four subjects were seated on chairs each facing one of the cameras. A single monitor in the room was viewed directly or from reflections in mirrors placed in the room. Feedback of a single channel of video from one of the four camera inputs was alternately presented on the monitor or blacked out. The subjects were instructed to attempt to communicate with each other through their cameras. Microphones suspended from the ceiling recorded sound and a speaker in the room allowed for communication with the subjects (this was kept to a minimum).

After an initial period of self-consciousness the subjects began to generate their own entertainment. During the session the subjects played with their mirrors and cameras, read poetry, drew, rapped, did somersaults.

A one-hour edited tape of this session is available from the Raindance Foundation, Box 135, Ruby, N.Y. 12475. Price on request. The original tape was recorded in January, 1969. The edited version is available on EIAJ I standard.

This environment was designed by Ira Schneider and Frank Gillette and recorded in the Antioch College Library in Yellow Springs, Ohio with students from the college, January, 1969.

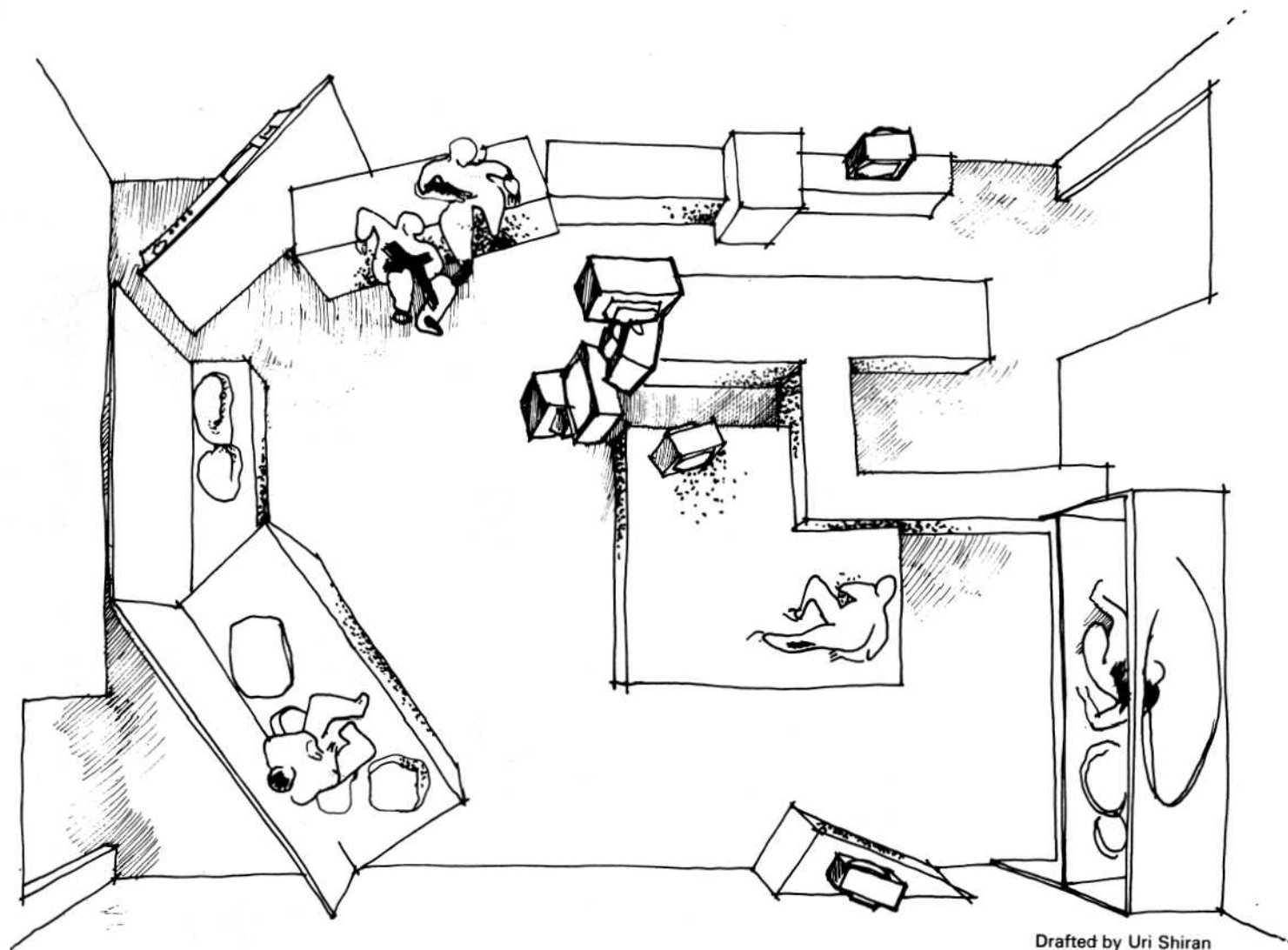

Drafted by Uri Shiran

# VIDEO THEATRE

We have had many requests from readers asking us for information on the structure of the video theatre we ran at our New York Raindance loft in the winter of 1970. The following is a description of the theatre, a diagram, and a financial statement.

Starting December 19, 1970 Raindance Corporation opened its loft at 24 east 22nd Street, NYC, for 10 consecutive Saturday evenings of cooperative videotape presentations with Videofreex, Peoples' Video Theatre, and others. A single channel of video (and audio) was selected from one of 3 Sony EIAJ decks or one of 2 Sony CV vtrs by means of a passive switcher. This number of vtrs allowed for rewinding and cuing up (through several preview monitors in the control area) of tapes for more integrated programming. Seven monitors were arranged in a space of approximately 55' x 22'. Seating was on comfortable cloth covered cushions on multilevel platforming creating many sub-environments. The space was laid out according to the diagram on the next page.

The major focus for most of the audience was a spire containing 23" monitors in the bottom and second rung, and 18" monitors on the third and top rung. People were able to look beyond the monitors and see other members of the audience. The ambience and decor seemed to dispell the traditional New York paranoia. People who had never met would rap with each other. This was contributed to by the programming which was made up of many short tapes (sequences)—many humorous, some ecological, informational, artistic. Melodrama and hardline entertainment with blasting sound was avoided. This again allowed the audience to rap and comment on the material they were viewing.

On the opening night 3 shows were presented 8, 10 and 12pm. Thereafter we had two shows at 8 and 10pm. Each week an ad was placed in the *Village Voice*. The cost of the ad and additional expenses such as nuts and raisins, cleaning supplies, etc. was subtracted from the gate and then the remainder was split 3 ways. Below we have listed the gate, cost of ad, total expenses and split to each of the contributing groups. (No fee was charged for rental of the space, electricity, etc. This must be figured in for anyone who wants to open and run a video theatre.)





Date	Gate	Ad	Total Expenses	Net Each
12/19	\$199	\$36	\$73	42
12/26	135	36	42	31
1/2	130	24	36	31
1/9	82	18	19	21
1/16	80	18	43	12
1/23	170	18	19	44
1/30	62	18	20	14
2/6	64	18	23	14
2/13	72	19	25	16
2/20	84	19	24	20

figures rounded to nearest dollar



PEOPLE'S VIDEO  
THEATRE  
RAINDANCE  
and  
VIDEOFREEX  
present

VIDEO EXPRESS  
and  
yipple takeover of  
Frost show  
sat.nites: Dec. 26  
8, 10 Jan. 2  
24 E. 22nd 2 flr  
982 5566 \$2.00

PROGRAM

women's lib  
street real  
hands  
PVT  
raindance  
RDC ivory soap  
dominick  
TVX,  
london  
buzzy  
VFX money  
frog

The following design offers the possibility for audience participation on a voluntary basis in on going multi-camera video productions which are presented live to the audience or taped for later editing and/or playback. Switching capabilities allow for presentation of pretaped programming from the studio and elsewhere while video production continues. The major features of this complete video facility include the following: a public viewing space combining cafe setting and platforms with comfortable foam cushions; a video studio space with remote control auto-focus/auto-zoom cameras, dimmer switch lighting, monitors for participant feedback seating platforms for those waiting to enter the activities; a control room containing camera monitoring, audio facilities, switching and special effects capabilities, editing and tape storage, and programming distribution facilities; additional space serves as small editing, duplication and viewing rooms, a pantry and space for office and tape packaging and shipping.

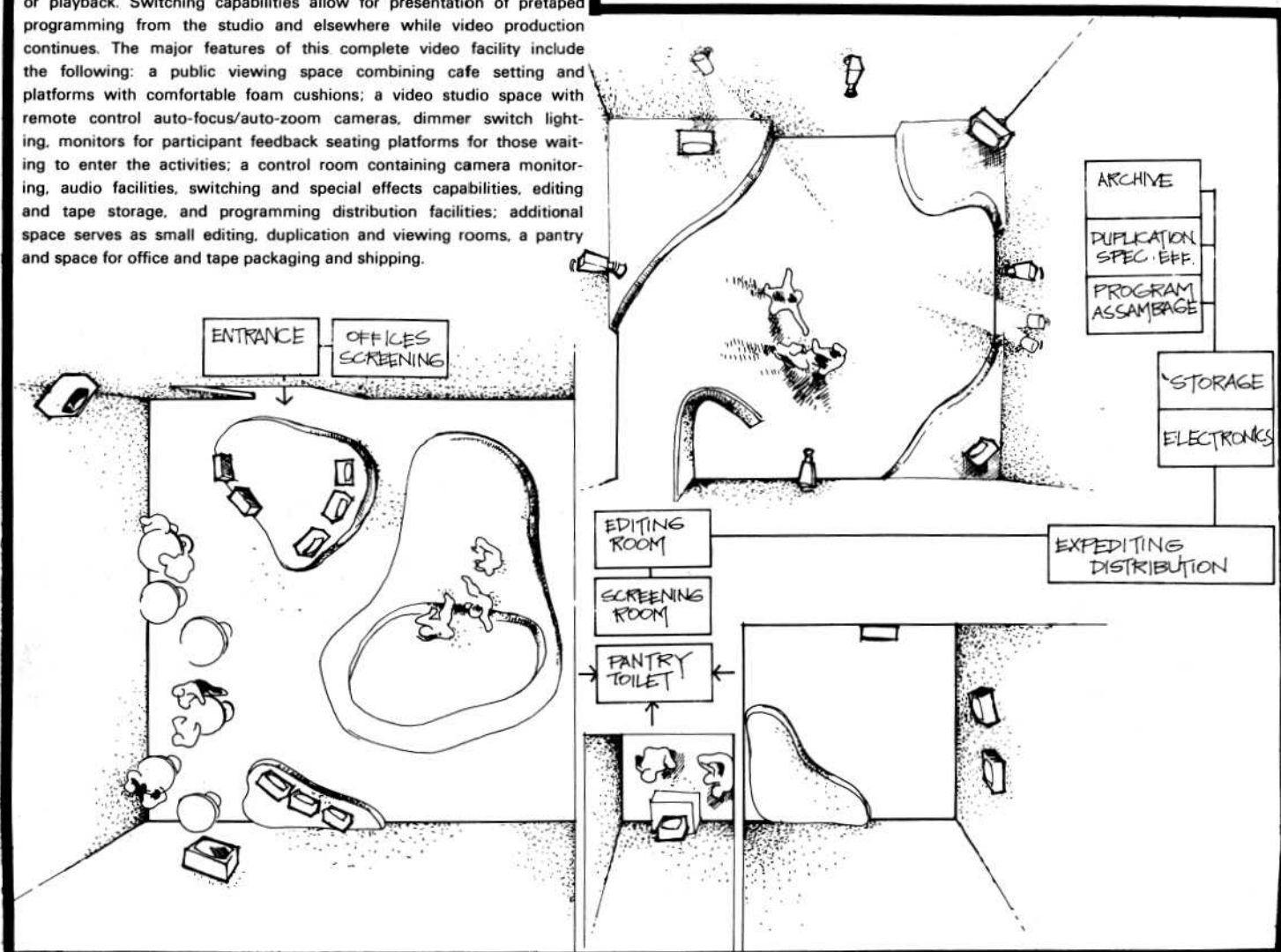

No man is an island, But Manhattan is.

## MANHATTAN IS AN ISLAND

# MANHATTAN

In a video space somewhere on Manhattan, 45 monitors are positioned to achieve a video space/time condensation of Manhattan. Five pre-taped channels of information include video recordings of: 1) a stroll along the streets immediately surrounding the video space: 2) and 3) bus rides and subway rides (by the shortest routes) each demarking differing perimeters of the transportation space surrounding the video space. 4) an automobile ride along the continuous belt of highways which border the island, and, finally, 5) video recording of Manhattan Island from the deck of a Circle Line boat.

The monitors are placed in positions isomorphic with the transportation-spatial content of the 5 different channels of information. The boat ride (outer perimeter of the videospace) is presented on the largest number of monitors and will be placed the highest (10 feet above the floor); the walk (inner perimeter of the video space) shown on the smallest number and positioned lowest (2 feet above the floor).

The duration of the 5 video recordings is determined by the length of the boat ride (approximately 3 1/2 hours) e.g., during which about 3 revolutions by car and approximately 100 circlings of the block occur. The direction of travel remains constant for all recordings.

If funds are available a video recording will be made from a helicopter above Manhattan & displayed on a single monitor suspended from the ceiling of the video space screen downward.

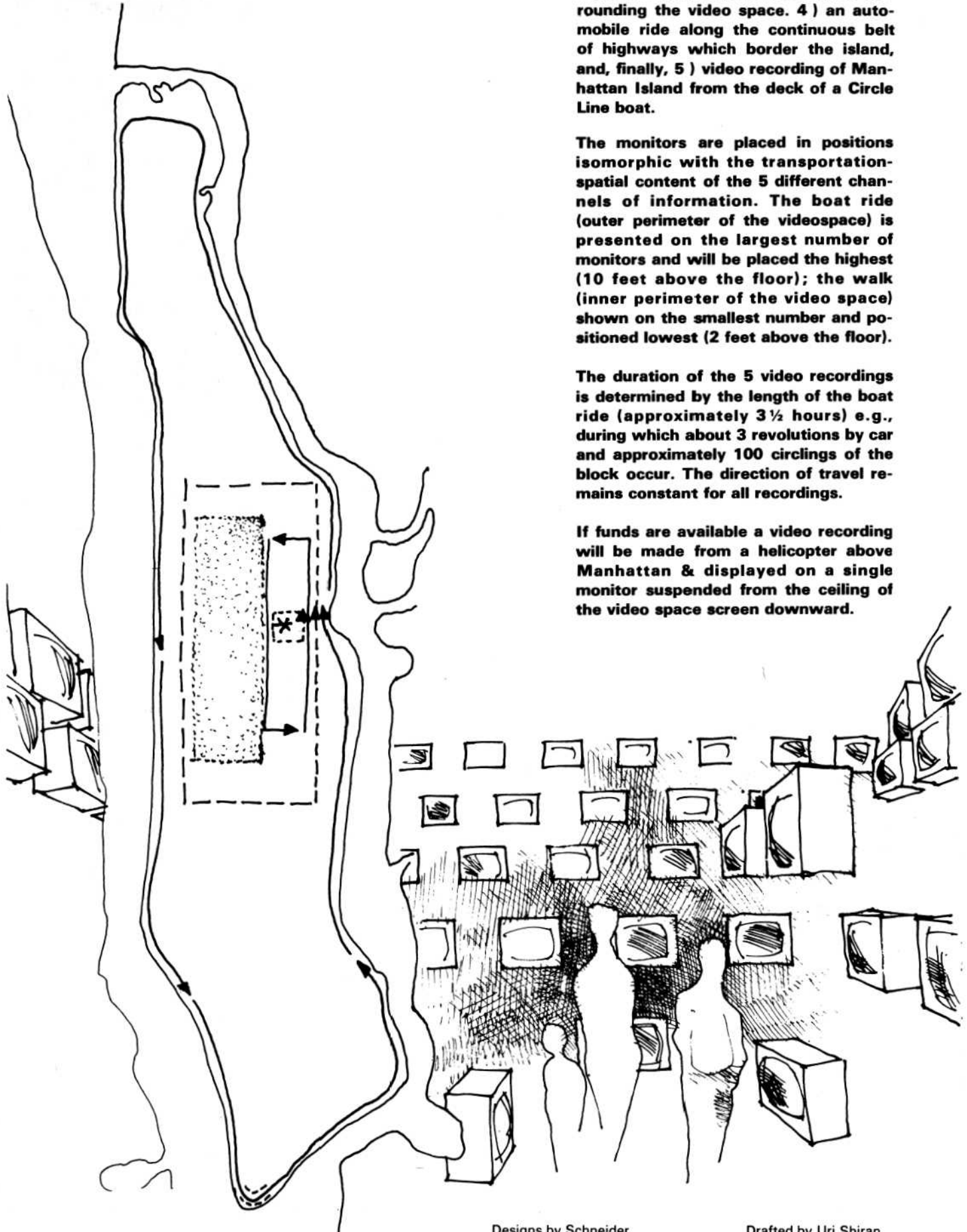

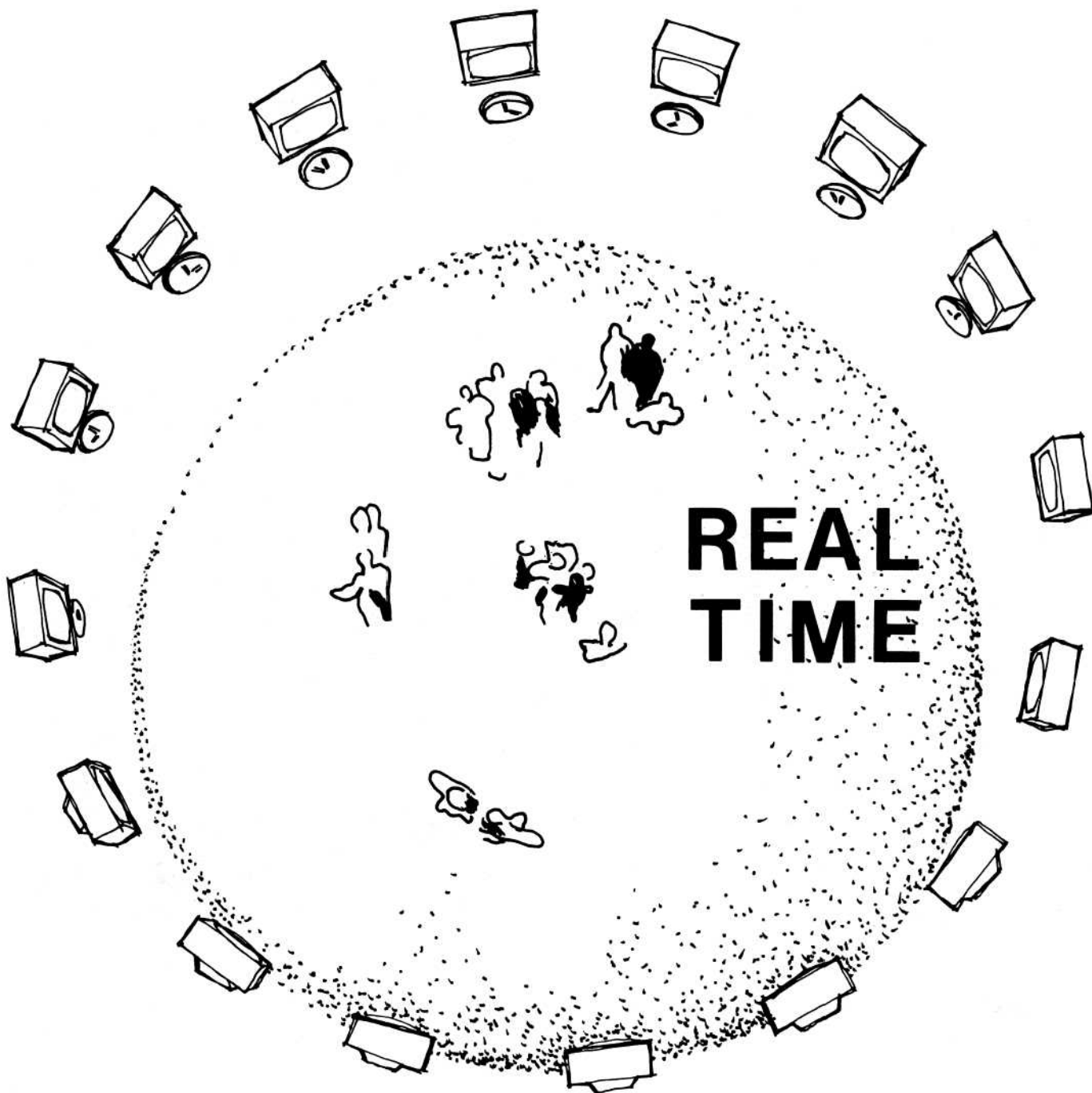

(a Video Environment for the USA Bicentennial Exhibition)

It is now technologically feasible to monitor aspects of the whole earth. In fact it is being done. However, the real time information thus generated is not generally made available to the public. The following is a proposal for an exhibition which permits the public to sense the simultaneity of micro-cultural events on planet earth:

Eighteen 25" monitors suspended seven feet above the floor and 6.28 feet apart circumscribe a space eighteen feet in diameter. Eighteen images are presented. Each is a real time telecommunication (via satellite) from eighteen major cultural centers around the planet. At each of these centers three camera positions are selected revealing macro- to micro- perspectives of the cultural environment by day or night. *Position one* reveals the overall contour, movement, size, and topography of each center. *Position two* presents exterior public spaces, e.g., a marketplace, streetcorner, mosque, etc. *Position three* includes interior spaces, e.g., an office, a nightclub, or a native's home. Flexible pre-programmed automated switching allows for the selection of the eighteen single camera views to be transmitted to the exhibition hall.

by Ira Schneider 1973

**ONE LOOK  
MANY POINTS OF VIEW  
ONE WORLD**



# MODULAR VIDEO MATRIX

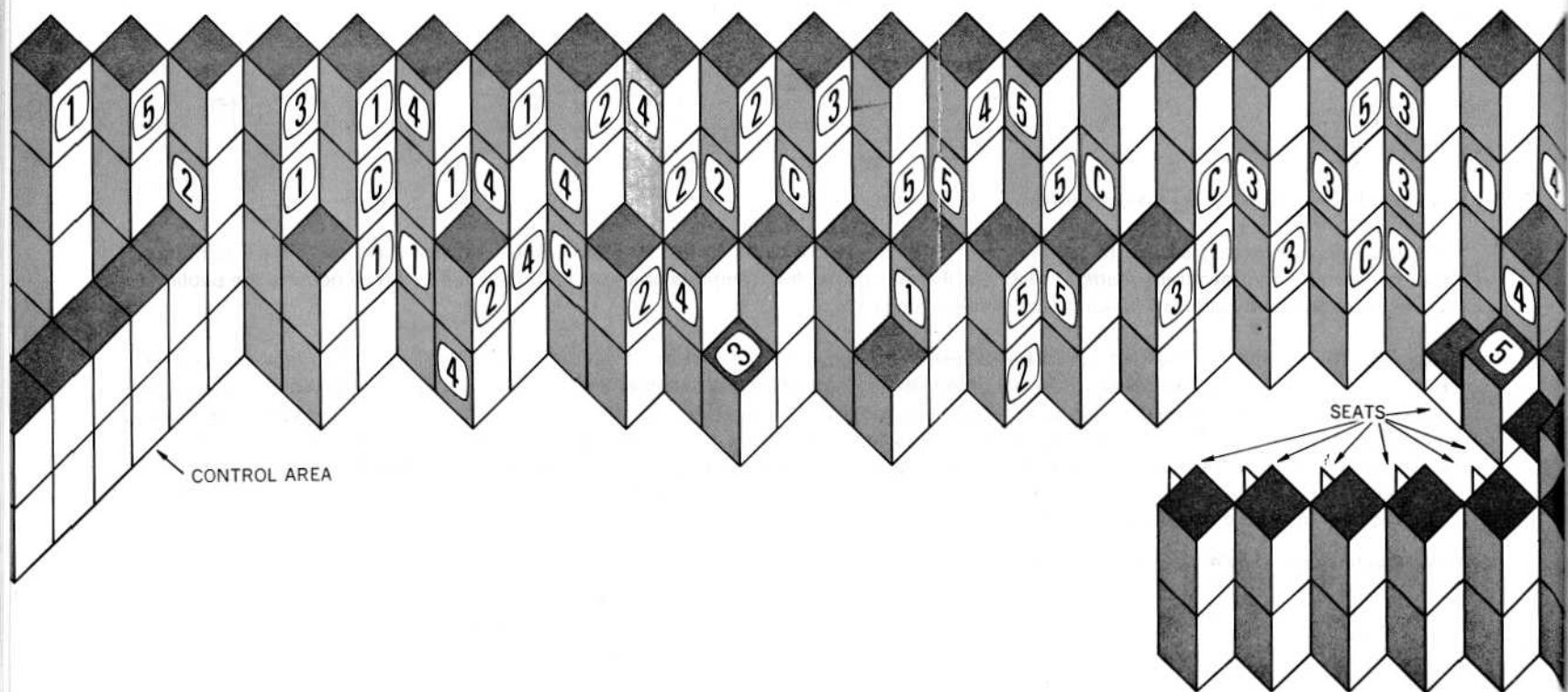

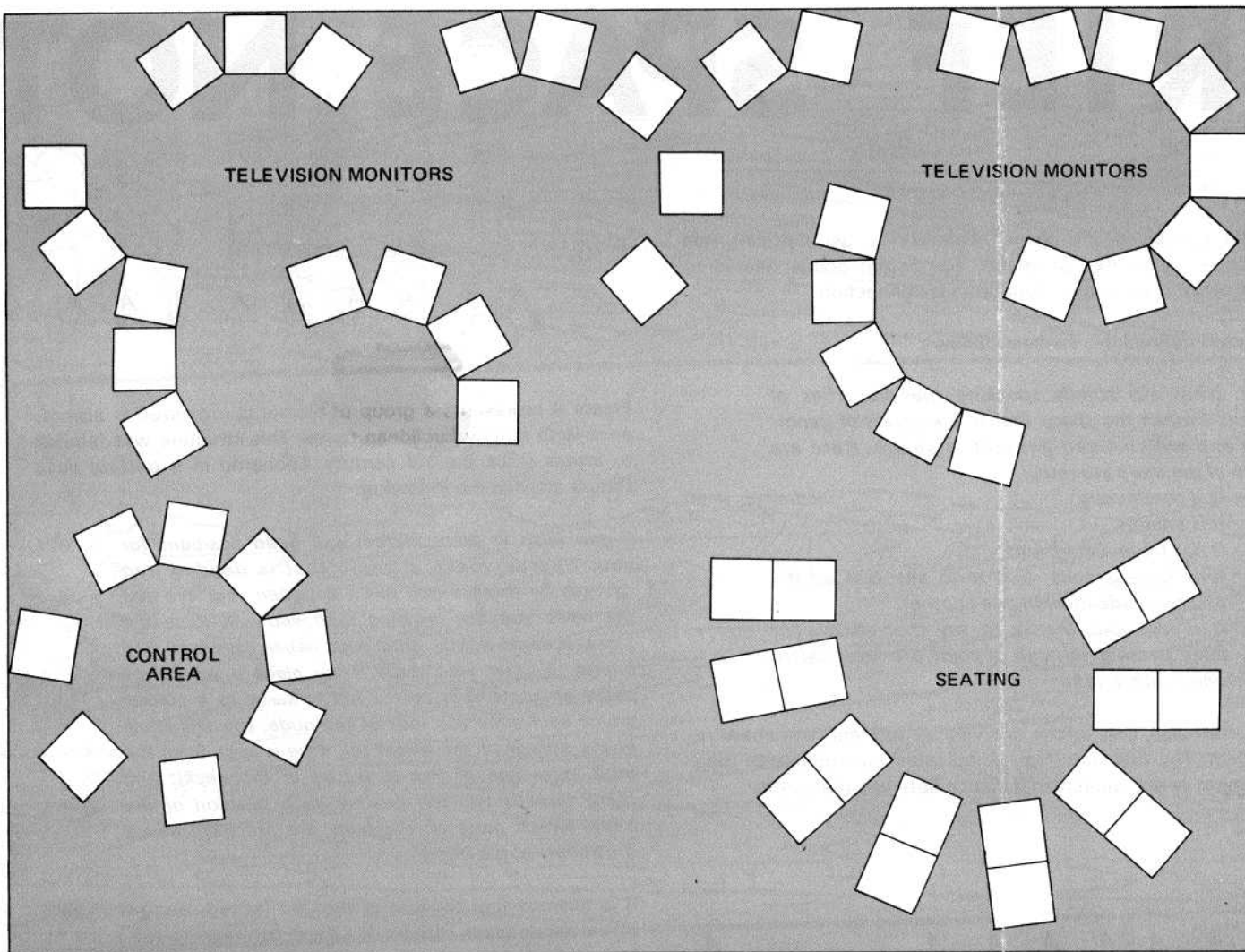

#### VIDEO MATRIX

- 50 monochrome 17" T.V. monitors
- 6 color 19" T.V. monitors
- 7 monochrome videotape recorders
- 2 color videotape recorders
- 7 crystal controlled live vidicon cameras
- 1 video distribution amplifier
- 5 control consoles
- 1 audio distributor
- 1 master switching console

The master switching console creates these video-matrix capabilities:

1. 5 separate videotape programs into 5 banks of 10 T.V. monitors
2. Automatic switching to live T.V. cameras in each bank after videotape program
3. Sixth videotape program optionally switched to all T.V. monitors at once
4. Live camera at control console switched to all T.V. monitors simultaneously
5. Color videotape programs into color monitors

The Modular Video Matrix designed by Frank Gillette and Ira Schneider with Paul Ryan and John Riley in 1969 offered flexibility in the configuration of video environments. 56 monitors encased in plexiglass with stainless steel supports allowed for stacking to produce a wall of monitors or for arrangement into circles, semi-circles, etc. Inputs from cameras were presented live, or were taped for later playback. 5 pre-taped programs could be presented simultaneously. Programming could also contain a mix of live, delayed, and pretaped material. This Matrix was designed for the American Can Corporation and contrary to the desire of the designers the software was assembled by Harvey Lloyd Productions. Software for the Matrix presented at Industrial Trade Shows consisted mainly of bald-headed men touting American Can products intermixed with men (live camera) gawking at cheesecake hostesses.

# BRIEF SPACE NOTE

Euclid conceived the space of reality as geometrical. This space is constituted of infinite equidistant points related to each other in a manner of continuous connection.

Poincaré defined this space as follows:

*First, what are strictly speaking the properties of space? I mean the space that is the object of geometry and which I call geometric space. Here are some of the more essential:*

1. It is continuous;
2. It is infinite;
3. It has three dimensions;
4. It is homogenous, that is to say that all the points are identical to one another.
5. It is isotropic, that is to say that all straight lines passing through a point are identical to one another. (1)

The examples that follow are very simple and somehow redundant. The first one (Fig. 1) indicates the equality of measurement or the equality of distance between the points.

FIG. 1



The second example (Fig. 2) refers to the equality of intervals between the points.

FIG. 2



$$A=B=C=D=E=F=G$$

The third example deals with the notion of the neighborhood of the points (The immediate adjacent of A 1 is A 2 and between A 1 and A 3 only A 2 exists) This property is called continuity. (2)

Space is homogeneous because all its elements are of the same nature and is isotropic because it maintains the same properties in any direction. It is infinite because it doesn't have boundaries and it is three-dimensional because it is a composite of three variables: length, width and height. These are the most essential properties of Euclidean space.

FIG. 3

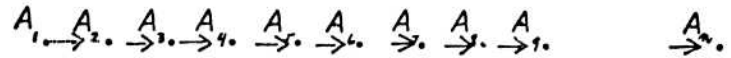
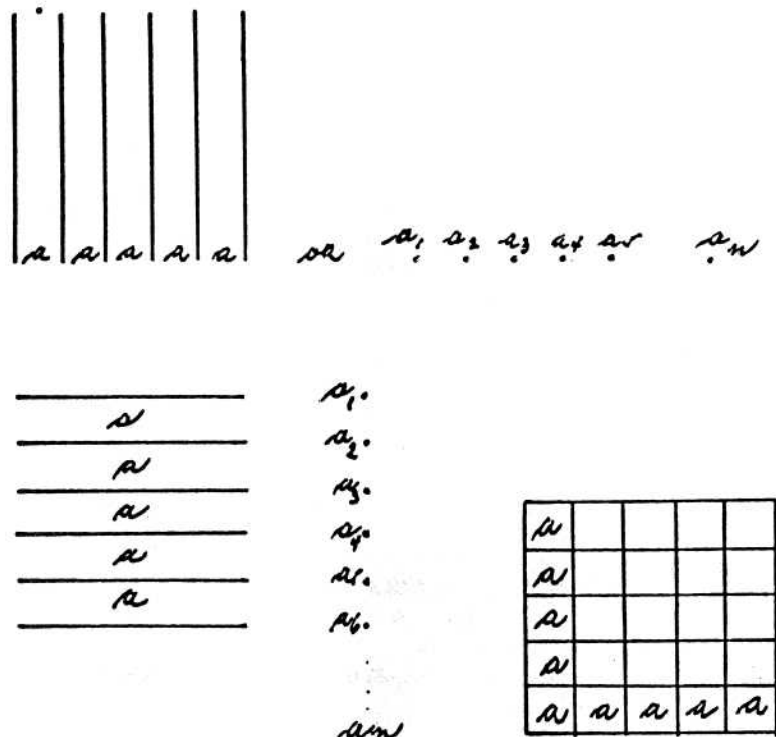

Figure 4 represents a group of elements organized in accordance with strictly Euclidean terms. This structure was familiar to artists since the XV century. Leonardo in *Il trattato della Pittura* advised the following:

*If you wish to learn correct and good positions for your figures, make a frame that is divided into squares by threads and put it between your eye and the nude you are drawing, and you will trace the same squares lightly onto your paper on which you intend to draw your nude. Then place a small wax pellet on some spot on the net to serve as a marker which each time you look at the nude, you will place at the hollow of the throat (or, if he is seen from the back, over one of the vertebrae of the neck); and these threads will tell you for each position of the body, which parts of the body are precisely below the hollow of the throat . . .*

It is obvious that the use of the grid for regulating the space of the rectangular canvas has been common to the artist for some time.

FIG. 4



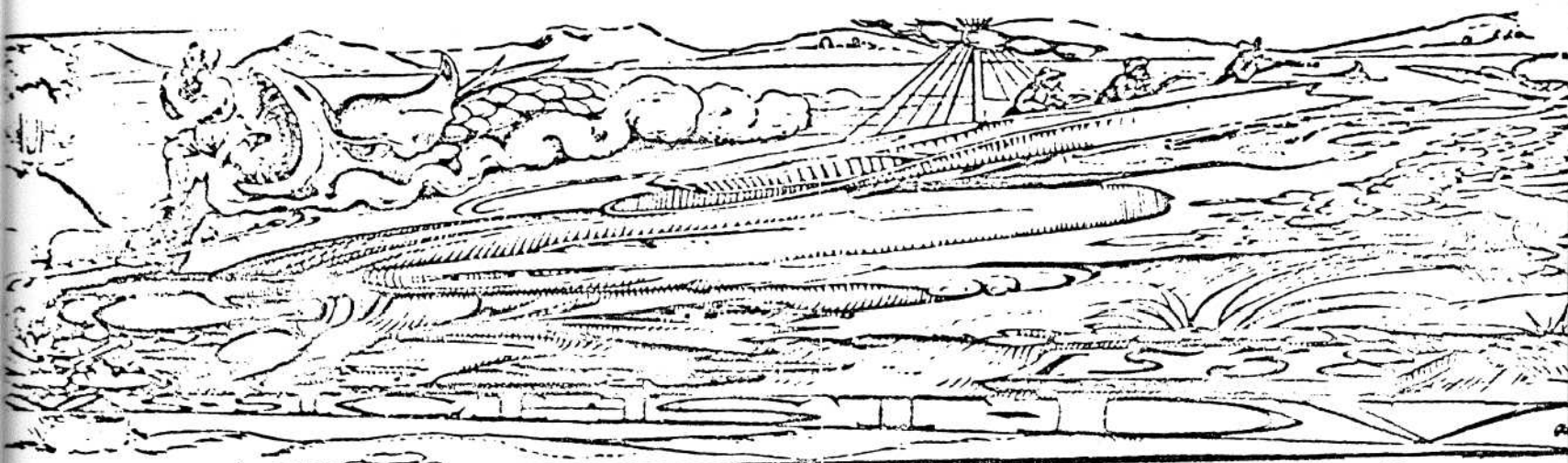
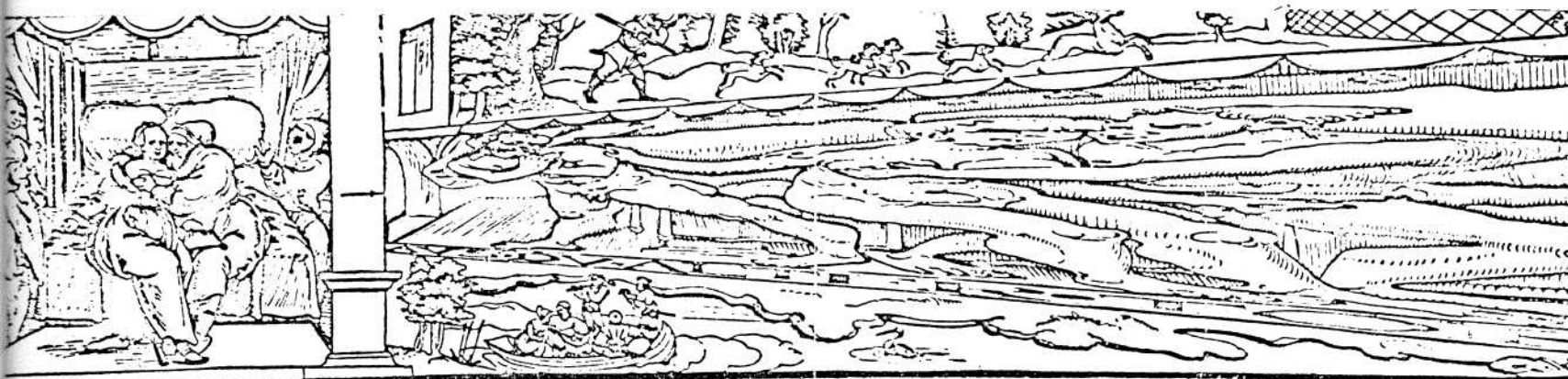

FIG. 5.

In the XVI century some artists tried to dislocate, so to speak, the structure of the pictorial space. The results of these *fancies* were called Anamorphosis (fig. 5). These representations, somehow, disregarded the notion of equidistance or the metrical constant of space. (The figures were disproportionate.) The distortion of the image conveyed a certain displacement of matter, and in a curious manner made the painting look more energetic than substantial. As far as I know these experiments have not been considered more than mere extravaganzas and have not been given much attention. (3)

Consequently, the arrangement of elements in accordance with the Euclidean scheme seems to have prevailed in most explorations in the rectangular canvas.

In 1876, William Kingdom Clifford published a paper in which he expressed the following:

- (1) *That small portions of space are in fact of a nature analogous to little hills on a surface which is on the average flat; namely that the ordinary laws of geometry are not valid in them.*
- (2) *That this property of being curved or distorted is continually being passed on from one portion of space to another after the manner of a wave.*
- (3) *That these variations of the curvature of*

*space is what really happens in that phenomenon which we call the motion of matter, whether ponderable or ethereal.*

- (4) *That in the physical world nothing else takes place but this variation, subject (possibly) to the law of continuity. (4)*

For Clifford, somehow, substance is an accident of space. This is the apotheosis of many centuries of thinking. In Aristotle space is identified with place and defined as adjacent boundary of the containing body. Aristotle conceived space as a contingency of matter. Clifford reversed this concept and in a very beautiful manner ended with the reign of the Euclidean conception. Space is not homogenous; it has turbulences where the laws of Euclidean geometry are not the case. The notion of regularity, then, is lost. Space behaves in a manner comparable to jelly. In Figures 6 and 7, I try to convey this notion. Since these notes are somehow paradigmatic I started the example with an image enclusted in a regular grid (Euclidean) and then transformed it, through a conformal transformation, into a *new grid*. This grid is not metrical, the intervals between its elements are not regular, the straight angles have been lost, the only possible invariant kept is that of the neighborhood of the points. This image, then, expands and contracts accordingly. In the *old order* the displacement of a body in space did not affect its metrical properties; in this new grid the image changes size continuously.

What I have described so far are conceptions of space. We shouldn't forget, nevertheless, that these conceptions are human conceptions and that space, as a form of the natural phenomenon, is independent of human thought. Whatever I have described then, is a function of our conceptual scheme. Nature is independent of human thought.

*The same certainty that characterizes the relativity of motion accompanies the principle of the relativity of magnitude. We must not let our courage fail in maintaining this principle, according to which the size of a body at one moment does not determine its size at another (5)*

*As Sartorius von Walterhausen reports, Gauss considered the three-dimensionality of space not as an inherent quality of space, but as a specific peculiarity of the human soul. (6)*

Last hint:

*The concept of space can be summarized in a telegraphic manner: Pertaining to the cosmos: Space-void-emptiness-receptivity-Ch'i (Spirit)-heaven-Tao; Pertaining to man: Space-emptiness-receptivity-purity-chi (Spirit)-harmony-with-the-Tao. (7)*

Enrique Castro-Cid

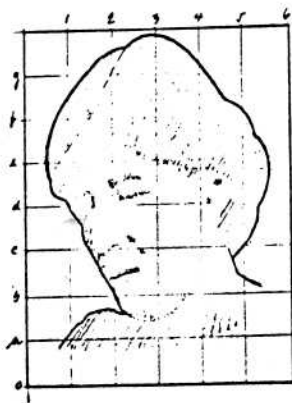

FIG. 6.

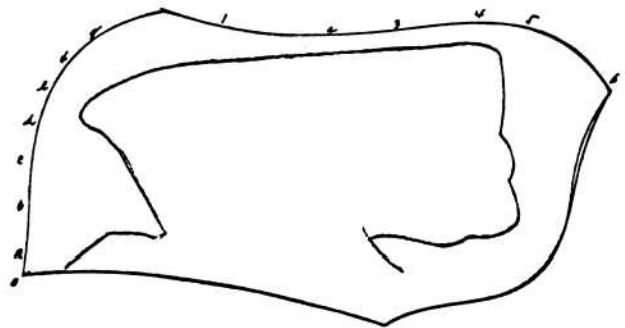
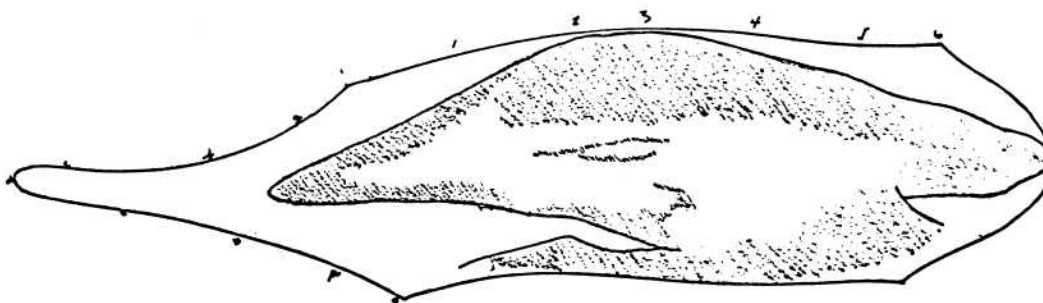

FIG. 7.



Notes

- (1) Henry Poincaré, *Geometry and Space*.
- (2) "For this reason we endeavor to track back all conceptions of continuity to the conception 'between', i.e. to the relation A is a point of the straight line BC and lies between B and C." See Fig. 3 bottom. Hermann Weyl, *Space-Time-Matter*, p. 12.
- (3) For more on Anamorphosis see Jurgis Baltrusaitis,

*Anamorphoses, ou magie artificielle des effets merveilleux.* Olivier Perrin, 1969.

- (4) Proceedings of the Cambridge Philosophical Society, 1876.
- (5) H. Weyl, *Space-Time-Matter*, p. 283.
- (6) Sartorius von Walterhausen, *Gauss zum Gedenken*, vol. 8, p. 268.
- (7) Mai-Mai Sze, *The Tao of Painting, 1679-1701*, p. 95.



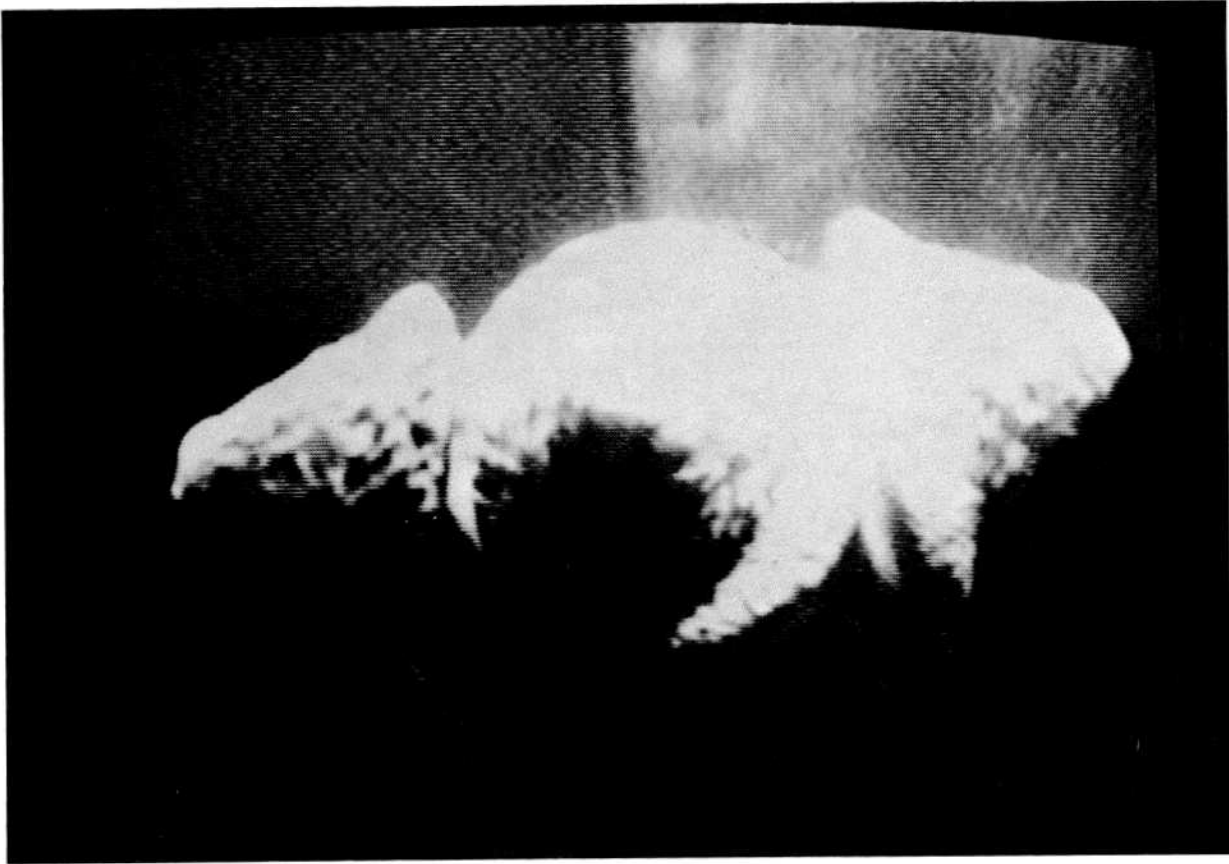

Frank Gillette

SIX MATRICIES  
(1971-1973)

Track/Trace  
Tetragrammaton  
Terraquae  
Intergration Matrix  
Subterranean Field  
Gestation/Growth

Installed at the Everson  
in the spring of 1973.  
Photographed by Bob Lorenz  
and Kirby Smith.

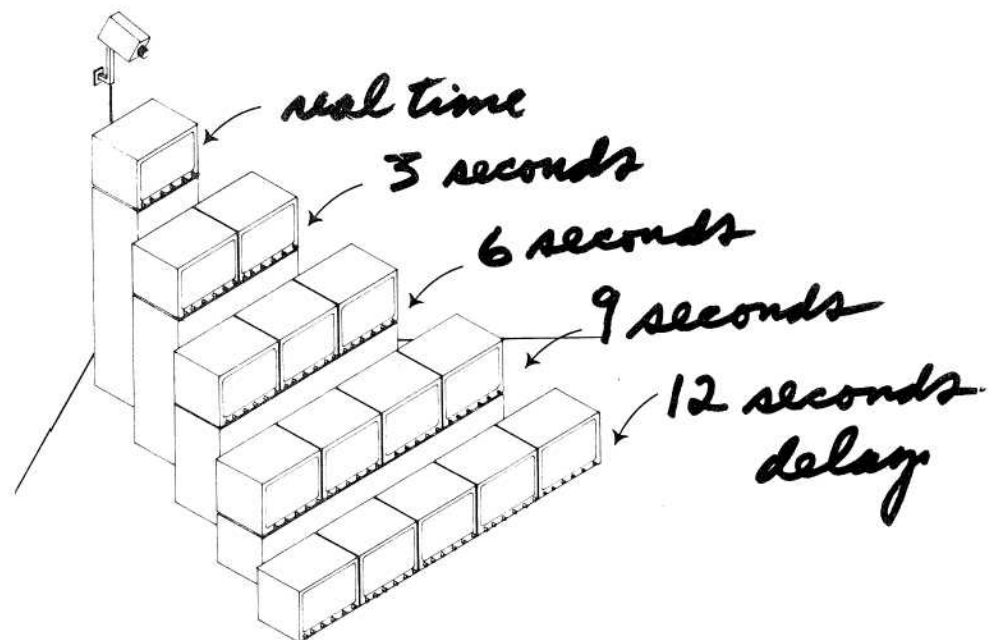
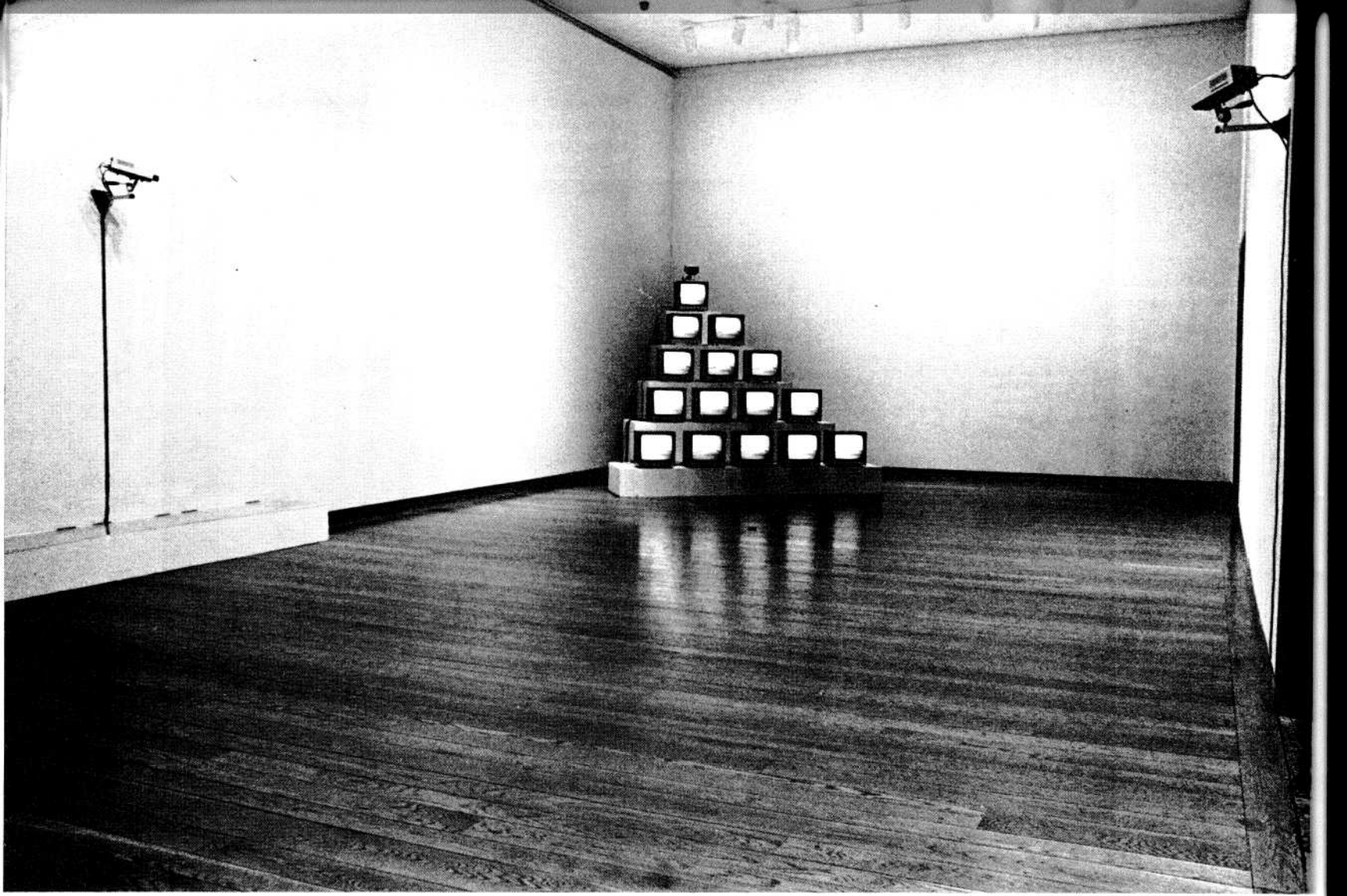

*Track/Trace*: Three television cameras record and transmit the contents of the gallery to a matrix of 15 television monitors arranged in the face of a tetrahedron. A switcher changes images every eight seconds. One television monitor is mounted at the apex, two televisions are mounted on the second row down, and so on to the bottom row, which contains five monitors.

A television camera pointed at the observer feeds a "live" real-time image to the single apex monitor. The image is delayed three seconds and then replayed on the second row. It is then delayed an additional three seconds (a total of six seconds) and replayed on the third row. The process

continues until the bottom, or fifth row, displays the original image 12 seconds after it appeared on the top monitor. These images, and those from two other television cameras placed in the environment, are alternated on the monitors. All 15 monitors feed back their contents simultaneously.

*Track/Trace* incorporates the audience as content. The viewer becomes the information, which he receives both in real time and in four layers of delayed time, so that he experiences "self" at five different periods in time, simultaneously; and from three different points in space, sequentially.

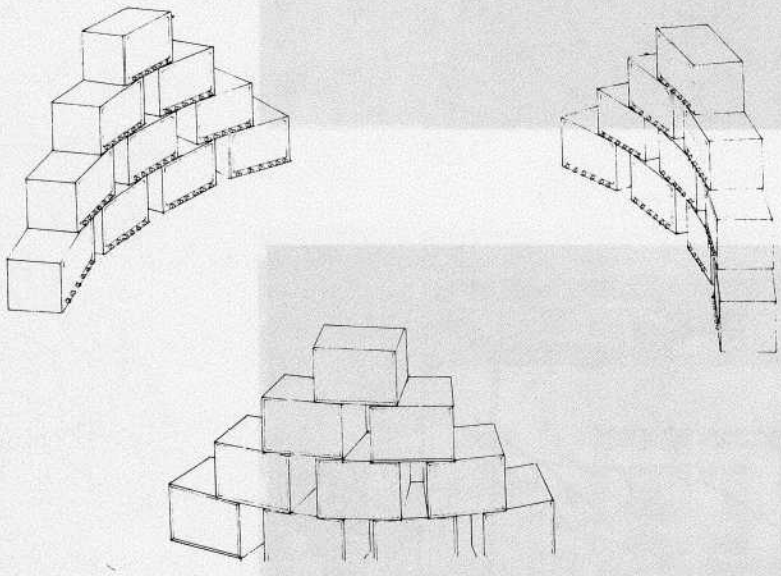
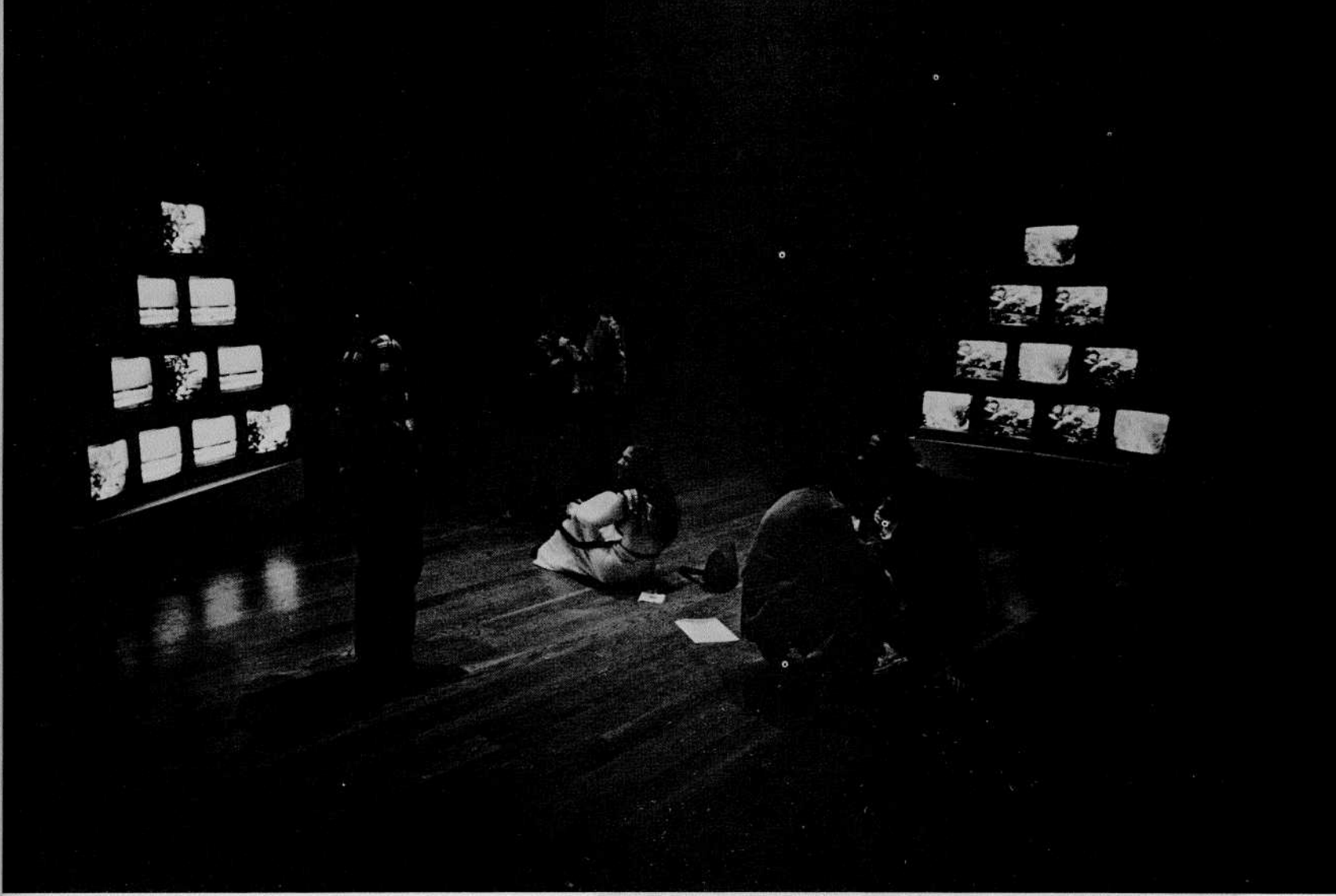

**Tetragrammaton.** Thirty television monitors are placed equidistant around a 25 foot diameter circle, in three sets of ten. Each set of ten is stacked to form an equilateral triangle. Six channels of video information are simultaneously displayed on the monitors, two different channels to each stack of ten.

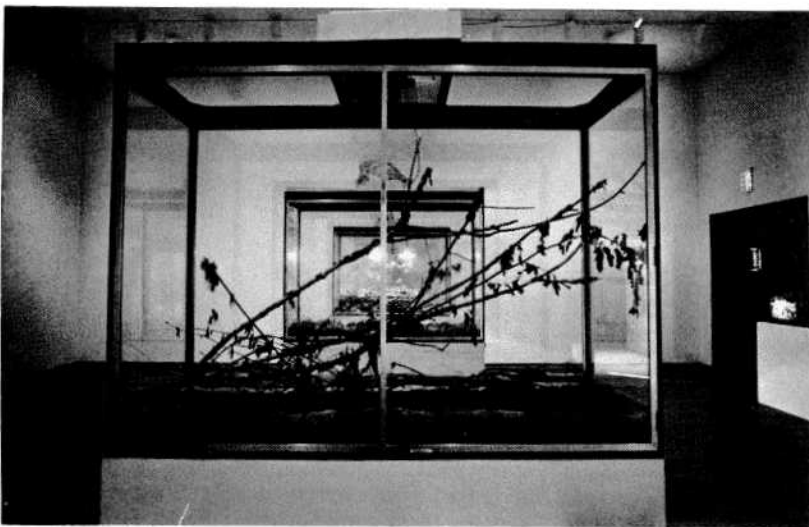
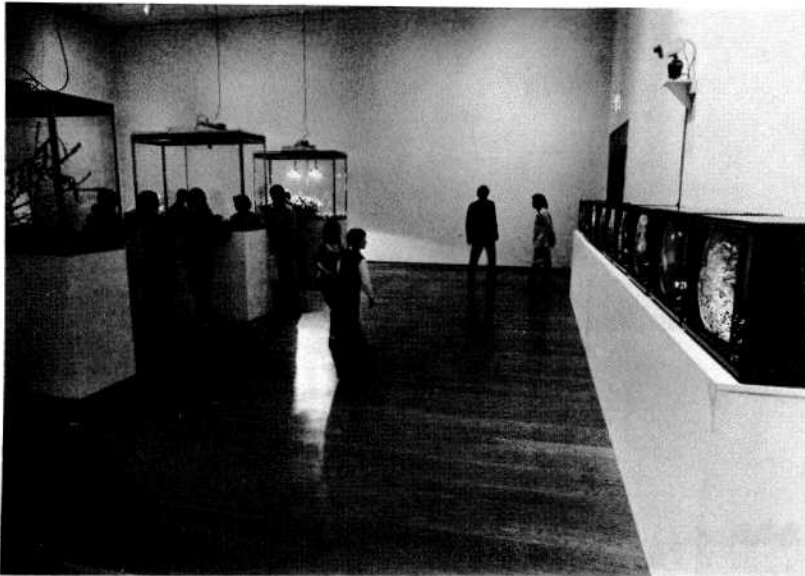
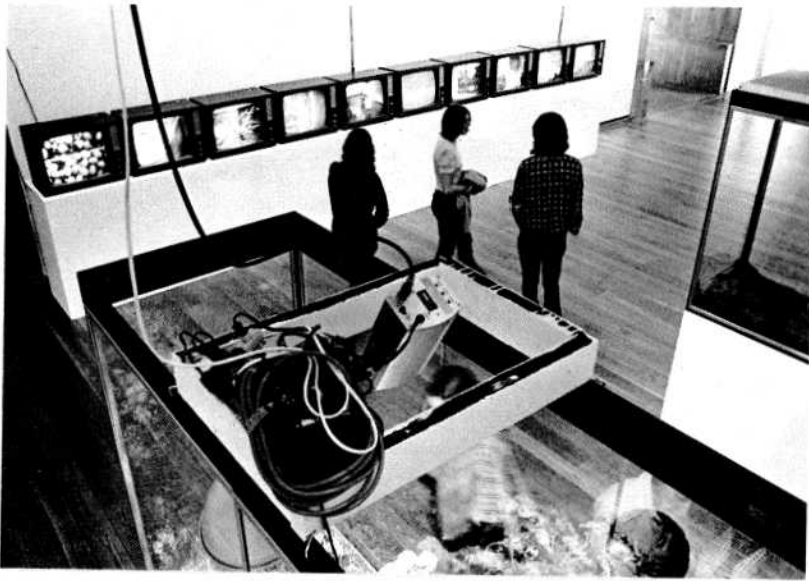

*Terraquae*: Five identical cases, nine feet high, six feet long, two feet wide, are positioned down the center of the gallery. A television camera is mounted at the top of each case. The camera scans the contents of the cases and transmits it, in real time, to a horizontal matrix of ten monitors in the same gallery.

Each case houses an evolving life cycle: metabolic exchange, symbiosis, birth/growth and decay/growth. The first case contains agar, spores and

bacterial molds; the second, iguanas and geraniums; the third, snails, slugs and insect larva; the fourth, tortoises and tarantulas; the fifth, shell life, crabs and crickets.

The processes occurring in the systems evolve and exchange at different rates. The television cameras/monitors depict these systems as information. The audience's participation of both levels produces a third, or meta-level.

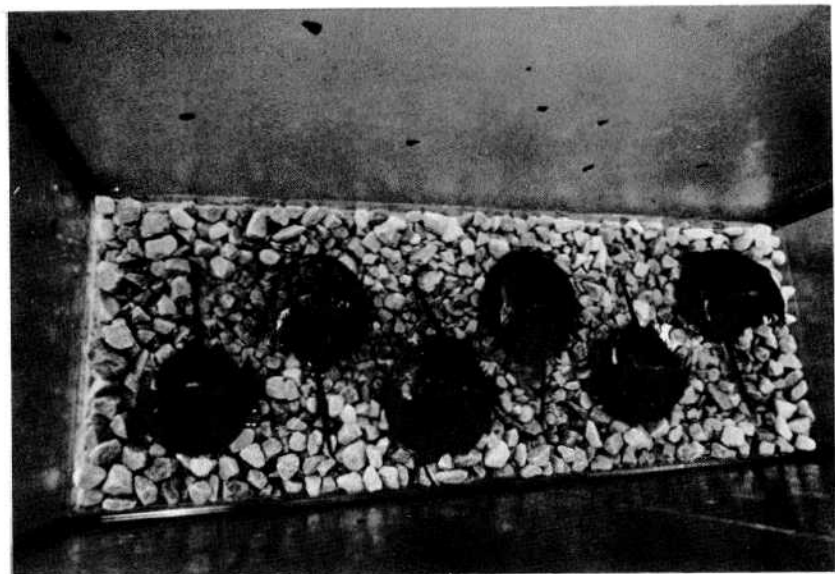
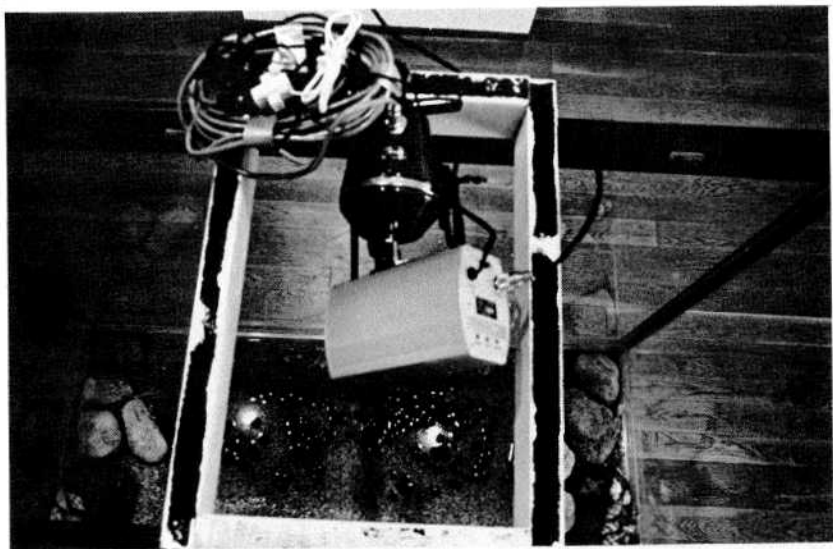
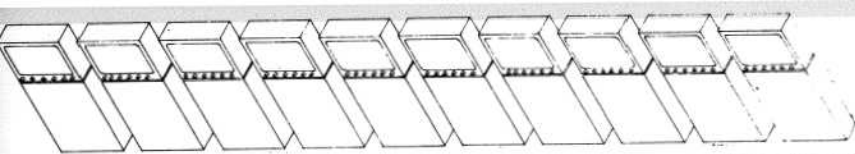

*Integration Matrix:* Ten monitors display the information from *Track/Trace*, *Gestation/Growth*, *Subterranean Field* and *Terraquae*. This integration of information from the different ecological systems exposes the differences and similarities between the systems.

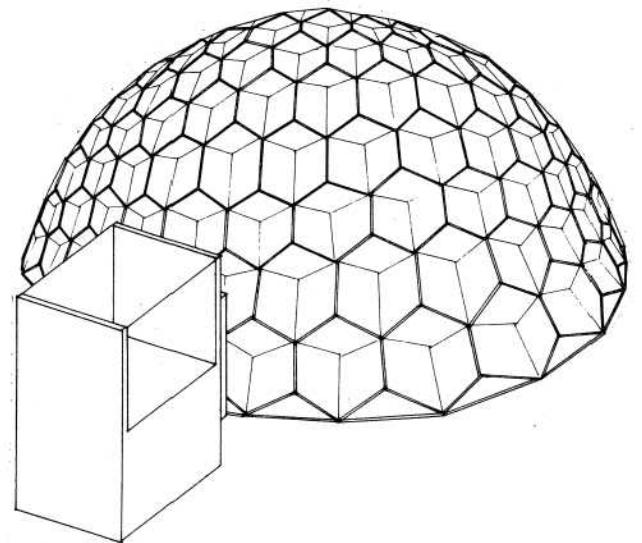

**Gestation/Growth:** At the center of the gallery an 18 foot diameter geodesic dome is connected to an incubator. Each day a row of eggs hatches and the chicks enter the dome to grow. The environment continues for 21 days, the gestation period of a chicken.

Two scanning television cameras translate the birth/growth process into information via closed circuit television. The images are displayed on a matrix of monitors in an adjacent gallery. The processes inside this environment are both discontinuous and continuous; i.e. eggs evolving into chickens, and the growth of chickens into maturity.

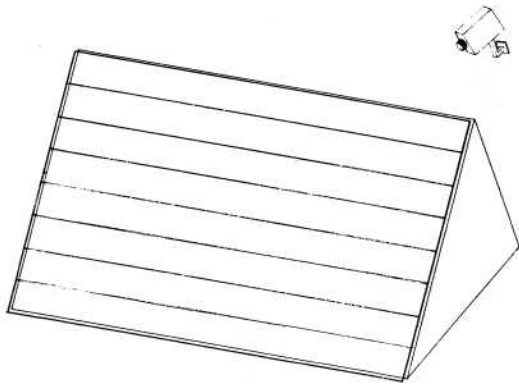

Detail, Terraquae



Detail, Terraquae



Detail, Terraquae

*Subterranean Field:* Along the wall of the gallery, a closed environment, six feet high and eight feet long, houses approximately 10,000 termites and cherry wood veneers. The termites devour the thin sheets of wood, creating random patterns. Two television cameras scan the evolving ecological process from above and transmit the information to a matrix of monitors in the same gallery.

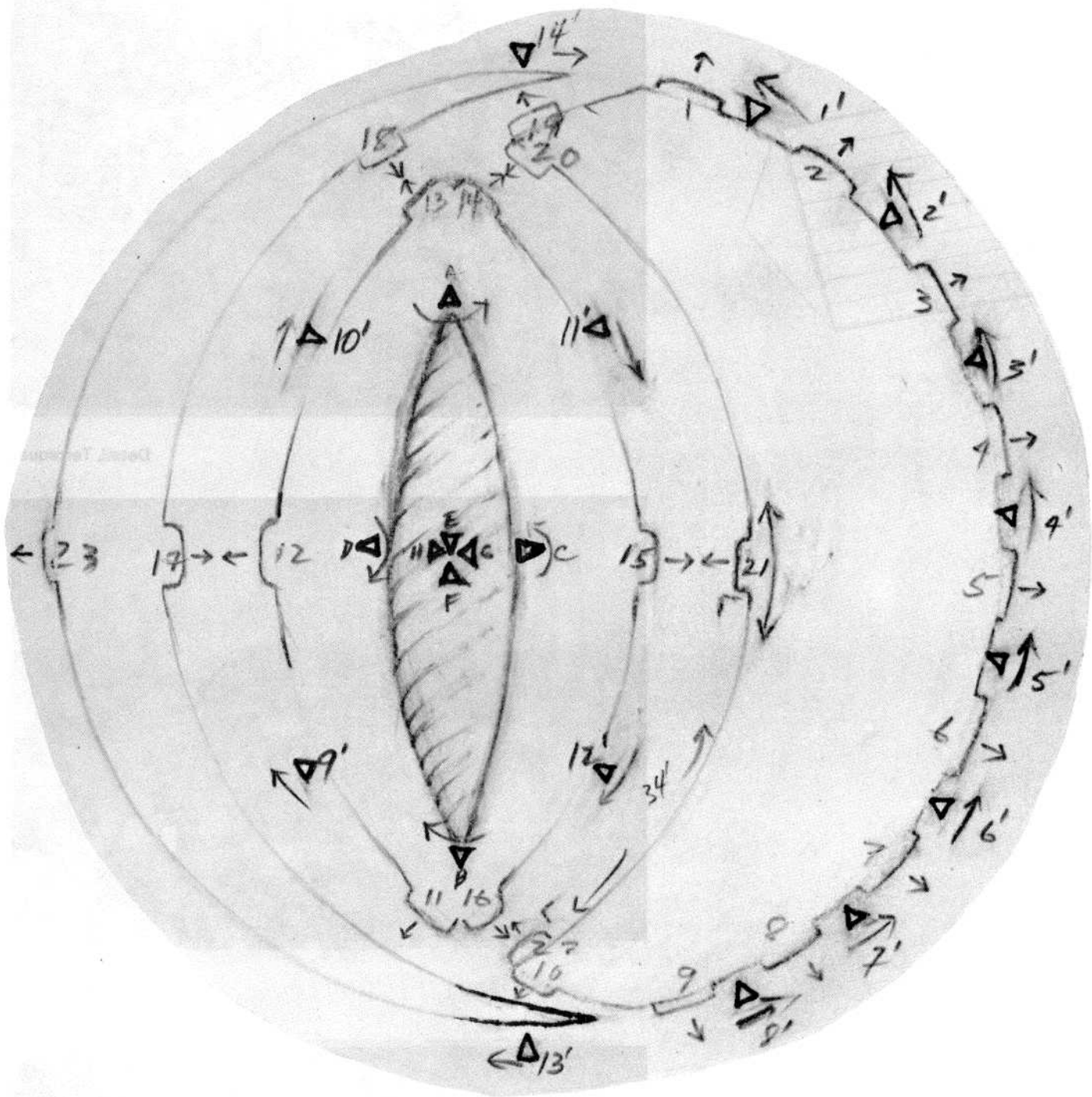

PROPOSAL: MAZE, a circular network of intercommunicating paths, 120 ft. in diameter, placed in a field of high grass or dense brush. A congruent, corresponding network of twenty two scanning cameras and twenty three monitors positioned at varying intervals along the paths. Feed from the cameras is relayed to a twelve level time-delay loop, such that a participant in the maze always encounters an earlier image of himself as he moves to the center of the network. Frank Gillette(1972-73)



# TRANSFORMATIONAL VIDEO

by Ned Bobkoff

Performing is an act that has something to do with learning from experience and using what you have learned to grow into something you have never been before. *Character* can be thought of as what the performer becomes in the act of growing into it, a process, as opposed to a rigid previously grounded concept, a superimposition of behavior, or a systematic collection of effects. It is a process that has never occurred before, done by this person in this time in this place with these means, so that it stands out directly as his own, and at the same time, *someone we recognize*.

Video feedback is an effective tool for making that process palpable to the performer, helping him to achieve self-transformation, and turning it into an art. Taped images, combined with a live performer and closed circuit TV, can also create a fresh, lively, and new perspective for the audience as well. I explored this recently staging Samuel Beckett's *Krapp's Last Tape*.

The play is a moving, compressed, oddly provocative memory play, telescoping time. A constipated sixty-nine year old recluse spends his time listening to tapes made when he was younger, in this instance, when he was thirty-nine years old. Without changing the lines or the sequence of events, we simply substituted video for audio tape. The effect mesmerized us. It gave us an opportunity to choreograph the minute physical changes and the interplay between Krapp at thirty-nine on videotape and Krapp onstage live at age sixty-nine. An intense choreography of protracted movement basic to Beckett's aesthetic. For the performer, Jac Trapp, video created a fresh dimension, a way of reaching into himself and creating *character* without the use of indirect and remembered observations, traditional stereotyping or generalized indications.

Our objective was to find a way for Jac to become open to *how* his behavior affected his expression of it, and to help him understand *what* in his behavior created the knowledge of *how* he was doing it. We wanted the technique to make immediate sense, so that *mistakes* could be eradicated promptly and insights capitalized upon efficiently. We wanted it to occur in a fluid and natural manner, without a break in rhythm or tension.

We set up and treated the video monitor as a kind of *confession* box. There was no movement of the camera; it simply witnessed—patient, stationary, and still. Jac's face was lighted so that its naturally strong structure was sculpted on the monitor like a bas-relief, the high contrast of the medium sharply defining what is usually only fat in the mind's eye. Playing directly into the monitor, he made, immediately, contact with himself, controlling his images, and transforming himself on the spot.

A rich and evolutionary catharsis took place. He became intimate and passionate, the charm and impact of the feedback carrying him away. He worked like a painter, using his face like a brush, subtly, with penetration, and at the same time, shaping a keen and rigorously defined physical expression of Krapp at thirty-nine. And he performed Krapp's long monologue on the first take without a break.

He later testified to the effect the *confession* box had on him. He felt as if he had been carried along on a *slide of emotions*, the intimacy allowing him to reveal feelings he didn't know existed, feelings he had previously kept guarded in rehearsal and public performance. In short, it opened him to new possibilities of expression, and helped the audience gain new insights into the play and their experience of it.

We had pressed the past, the present, and the future together. We now had three images of Krapp to work with during performance. The live high-contrast image on the monitor, like a death mask, a ghostly haunted presence, a projection into the future, plus Krapp at thirty-nine, recorded on tape, mobile and passionate. Finally, the live Krapp onstage, fleshed out with the ashes of himself—a stark presence of loneliness and despair. Especially now that he had passed through the machine and back into himself.





**Vito Acconci**, New York  
Born 1940, New York  
Sonnabend Gallery, New York  
*Face Off* (15 min. B&W), *Overtone* (15 min. B&W)



**David Atwood**, Boston  
Born 1942, Boston  
WGBH-TV, Boston  
selections from *Mixed Bag*, *Jeremy Steig*, and  
*Mainieri Quartet* (20 min. C)

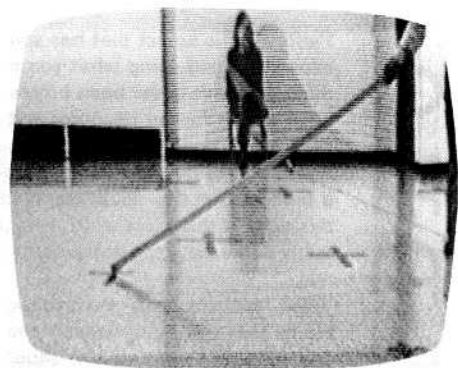

**John Baldessari**, Santa Monica, California  
Born 1931, National City, California  
Cal Arts Faculty  
*The Birth of Art and Other Sacred Tales* (30 min. B&W)

## CIRCUIT: A VIDEO INVITATIONAL AT THE EVERSON MUSEUM OF ART, SYRACUSE, NEW YORK

The rapid development of video as an accessible artist's medium has raised the question of its practicality in a system with no real support or distribution structure and hence a limited viewing public. The lack of applicable models, petty rivalries and grant competition are minor problems compared to the lack of an inexpensive distribution format. Many artists have found they have over-estimated their demand by support industries (cable television and audio recording concerns), and that these industries intend to develop these systems at a pace designed to maximize their profits and their control of the marketing of video.

One solution has been to provide a temporary context for the exhibition and distribution of works by video recording artists. The museum exhibition format provides such a context, and simultaneously acts as a catalyst to change information systems still incapable of dealing with art. "Circuit: A Video Invitational" is an attempt to create an informal network of museums, galleries and art centers sharing traveling exhibitions of video tapes and providing funds to participating artists on a cooperative basis.

The exhibition is an over-view of current video activity. 52 artists were invited to submit recent tapes for a showing that would occur simultaneously on the West Coast, East Coast and Mid West. The initial

exhibition of this 32 hour package was held in the Spring of 1973 at the Everson Museum of Art in Syracuse, New York; the Henry Gallery of the University of Washington in Seattle; and at the Cranbrook Academy of Art Museum in Bloomfield Hills, Michigan. These showings are to be followed by exhibitions at the Los Angeles County Museum, The Greenville County Museum in South Carolina, and other museums still unconfirmed as of this writing. Additional financing was also provided by The New York State Council on the Arts.

Works in the exhibition range from highly technical tapes employing computers and synthesizers; to documentary works, conceptual works and heavily edited image montages. Most of the tapes came from New York, although many are from California. A list of participating artists and photographs follows. Because the relative value of photographic stills taken off-screen remains debatable The Everson Museum prepared a 60 minute video catalogue of the Exhibition on video tape, which they sell for \$50 plus stock and handling costs. Inquiries about the "Circuit" exhibition and upcoming video exhibitions can also be addressed to the Everson Museum of Art, Syracuse, New York.

David Ross, Everson Museum of Art

**Stephen Beck**, Berkeley, California  
Born 1950, Chicago  
A.I.R. National Center for Experiments  
in Television  
*Undulations* (30 min. C)

**Lynda Benglis**, New York  
Born 1941, Lake Charles, La.  
Paula Cooper Gallery, New York  
Now (12 min. C), *On Screen* (7 min.)  
(B&W), *Collage* (9 min. C)

**George Bolling**, Santa Clara, California  
Born 1946, Columbus, Ohio  
de Saisett Gallery, Santa Clara  
*3 Series* (30 min. B&W)

**Peter Campus**, New York  
Born 1938, New York  
Bykert Gallery, New York  
*Dynamic Field Series # 7 and 9* (30  
min. B&W) *Double Vision* (30 min.  
B&W)

**Frank and Laura Cavastani**, New York  
Born 1943, New York and Middletown, New York  
Intermedia Foundation  
New York Video (60 min. C), *Sundance Ceremony  
Tapes* (30 min. B&W)

**Douglas Davis**, New York  
Born 1938, Washington, D.C.  
A.I.R. Television Laboratory, WNET-TV, New York  
*Studies in Color Videotape II* (30 min. C) *Studies in  
Black and White Videotape I* (30 min. B&W)

**Dimitri Devyatkin**, New York  
Born 1949, New York  
Electronic Kitchen, New York  
*Motown Edit* with Walter Wright (20 min. C)

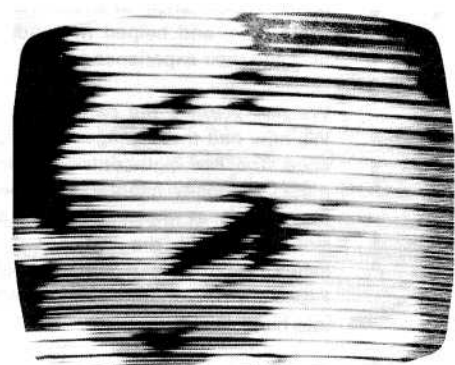
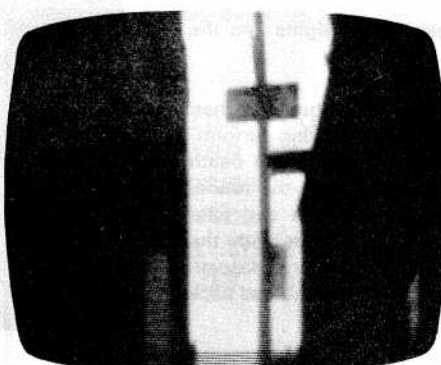

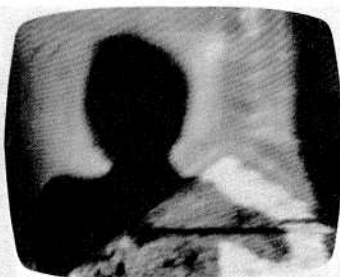

(Left)

(Right)

**Ken Dominick**, Binghamton, New York  
Born 1947, Springfield, Massachusetts  
Experimental Television Center,  
Binghamton, New York  
*Untitled Work* (30 min. B&W)

**Juan Downey**, New York  
Born 1940, Santiago, Chile  
Electronic Arts Intermix, New York  
*Plato Now* (40 min. B&W)

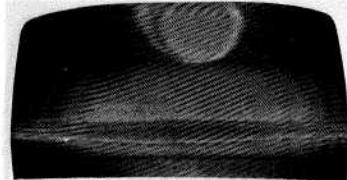

**Ed Emshwiller**, Wantaugh, New York  
Born 1932, New York  
A.I.R. Television Laboratory,  
WNET-TV, New York  
*Scapemates* (30 min. C)

**Terry Fox**, San Francisco  
Born 1943, Seattle, Washington  
*Incision* (30 min. B&W)

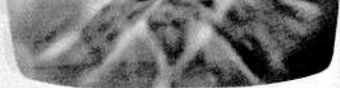

**Charles Frazier**, Kentfield, California  
Born 1930, Morris, Oklahoma  
*The Band Around the Bend in 'Pacific Ring'* (30 min. B&W)

**Hermine Freed**, New York  
Born 1940, New York  
Leo Castelli Gallery, New York  
*I Don't Know What You Mean, Glasses, Two Faces and Me and You* (40 min. B&W)

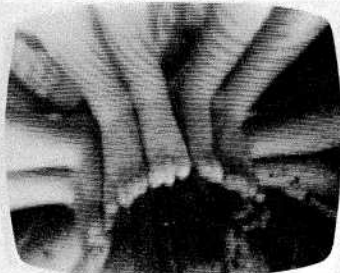

**Howard Fried**, San Francisco  
Born 1946, Cleveland, Ohio  
*Sea Sell Sea Sick at Saw/Sea Soar* (60 min. B&W)

**Frank Gillette**, New York  
Born 1941, Jersey City, New Jersey  
Electronic Arts Intermix  
*Hark Hork* (18 min. B&W)



**Joel Glassman**, San Francisco  
Born 1947, New York  
Mediacontact Gallery, Dusseldorf  
*Rattling Outside, Banging Inside* (30 min. B&W)

**Mike Goldberg**, Vancouver, B.C.  
Born 1947, Montreal, Quebec  
Video Exchange Directory, Vancouver, B.C.  
*Untitled Work* (60 min. B&W)



**Cynthia Grey**, New York  
Born 1947, New York  
L.C.A. Productions  
*Karma* (60 min. B&W)

**Ron Hays**, Boston  
Born 1945, Omaha, Nebraska  
Director of Music-Image Workshop, WGBH-TV, Boston  
*A Series of Short Works on Video-synthesizer and some improvisations done with Michael Tilson Thomas* (30 min. C)

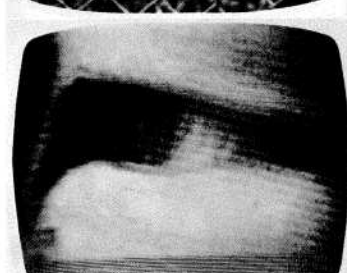

**Ralph Hocking**, Binghamton, New York  
Born 1931, Liverpool, Ohio  
Director, Experimental Television Center, Binghamton  
*Untitled Work* (30 min. C)

**Nancy Holt**, New York  
Born 1938, Worcester, Massachusetts  
LoGuidice Gallery, New York  
*Locating #1 and 2* (30 min. B&W) and *Zeroing In* (30 min. B&W)

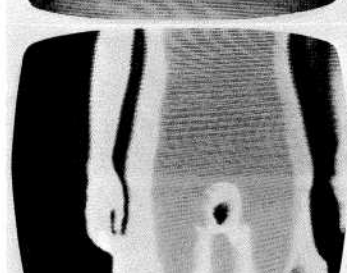

(Left)

**Taka Imura**, New York  
Born 1944, Tokyo, Japan  
*A Chair* (30 min. B&W) and *Blinking* (30 min. B&W)

**Beryl Korot & Ira Schneider**,  
Ruby, New York  
Born 1945, New York and 1939,  
New York  
Co-editors *Radical Software*  
*4th of July in Saugerties* (10 min.  
B&W), *The Boring Years* (10 min.  
B&W) and *Greatest Hits of the*  
*80's* (10 min. B&W)

**Shigeko Kubota**, New York  
Born 1948, Tokyo, Japan  
*Europe on 1/2 inch a Day* (30 min.  
B&W)

**Andy Mann**, New York  
Born 1947, New York  
Electronic Arts Intermix  
*Danger Flying Rock Zone!* (20  
min. B&W)

**Rita Myers**, New York  
Born 1947, Hamonton, New  
Jersey  
*Sweeps, Jumps, Slow Squeezes*  
and *Tilts* (60 min. B&W)

**Dennis Oppenheim**, New York  
Born 1938, Mason City, Washington  
Sonnabend Gallery, New York  
*Tooth and Nail* (20 min. B&W),  
*Nail Sharpening* (20 min. B&W)  
and *Forming Sounds* (20 min.  
B&W)

**Anthony Ramos**, Los Angeles  
Born 1947, Los Angeles  
Fat City School of Finds Art  
*Balloon Plastic Bag* (20 min. B&W)  
*Watermelon Heaven* (20 min.  
B&W), and *Water Plastic Bag*  
(20 min. B&W)

(Right)

**Joan Jonas**, New York  
Born 1936, New York  
Leo Castelli Gallery, New York  
*Left Side Right Side* (18 min. B&W)  
*Vertical Roll* (12 min. B&W)

**Paul Kos**, San Francisco  
Born 1942, Rock Springs, Wyo-  
ming  
University of Santa Clara Faculty  
*Black Holes* (60 min. B&W)

**Richard Landry**, New York  
Born 1938, Louisiana  
Leo Castelli Gallery, New York  
*6 Vibrations for Agnes Martin*  
(15 min. B&W), *Hebes Grande*  
*Bois* (8 min. B&W) and *4th*  
*Register* (12 min. B&W)

**Robert Morris**, New York  
Born 1931, Kansas City  
Leo Castelli Gallery, New York  
*Exchange* (40 min. C)

**Bruce Nauman**, Pasadena, Cali-  
fornia  
Born 1941, Fort Worth, Indiana  
Leo Castelli Gallery, New York  
*Tony Sinking Into the Floor Face*  
*Up and Face Down* (40 min. C)

**Nam June Paik**, New York  
Born 1932, Seoul, Korea  
A.I.R. Television Laboratory,  
WNET-TV, New York  
*Waiting for Commercial* (20 min. C)  
*B.S.O. Piece* (10 min. C)

**Peter Van Riper**, Valencia, Cali-  
fornia  
Born 1945  
Cal Arts Faculty  
*Changes # 1 and 2* (two 30 min.  
tapes C)

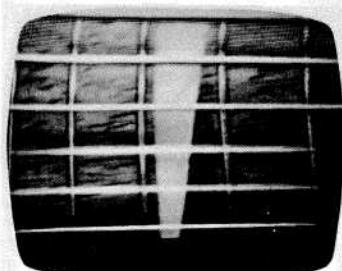
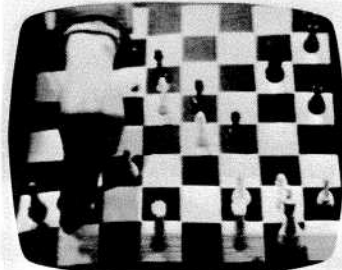
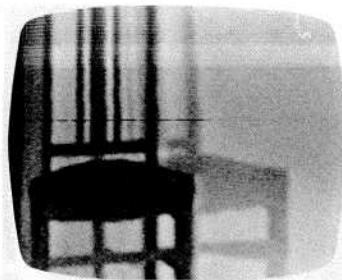

(Left)

**Richard Serra**, New York  
Born 1939, San Francisco  
Leo Castelli Gallery, New York  
*Television Delivers People* (9 min. C) *Hands, Catching Lead* (4 min. B&W), *Hands Tied* (8 min. B&W), *Surprise Attack* (12 min. B&W), *Hands Scraping* (10 min. B&W) and *Anxious Automation* (5 min. B&W)

**Eric Siegle**, New York  
Born 1945, New York  
Electronic Arts Intermix  
*Stockholm Visited* (30 min. B&W)

**Keith Sonnier**, New York  
Born 1941, Louisiana  
Leo Castelli Gallery, New York  
*Color Wipe* (30 min. C)

**N.E. Thing Company**, Bradford, Ontario  
Name registered, 1966, Incorporated, 1969, Victoria, B.C.  
*VSI # 3 and 4*, and *the N. E. Thing Co. Hockey Team* (60 min. B&W)

**Videofreex**, Lanesville, New York  
Established 1969, New York  
*Lanesville TV Retrospective* (30 min. B&W)

(Right)

**Willoughby Sharp**, New York  
Born 1936, New York  
Editor, *Avalanche*  
*Willoughby Sharp Videoviews*  
*Vito Acconci* (60 min. B&W)

**Michael Snow**, Toronto, Ontario  
Born 1939, Toronto, Ontario  
Bykert Gallery, New York  
*3 Breakfasts* (30 min. C)

**Aldo Tambellini**, Brooklyn, New York  
Born 1931, Syracuse, New York  
A.I.R. Television Laboratory,  
WNET-TV, New York  
6673 (60 min. C)

**Woody and Steina Vasulka**, New York  
Born 1934, Czechoslovakia and 1938, Iceland  
Electronic Kitchen  
*Home* (30 min. C)

**William Viola**, Syracuse, New York  
Born 1951, New York  
*Instant Replay* (30 min. B&W)

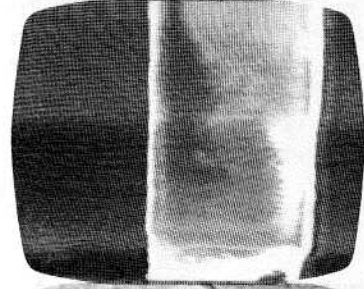
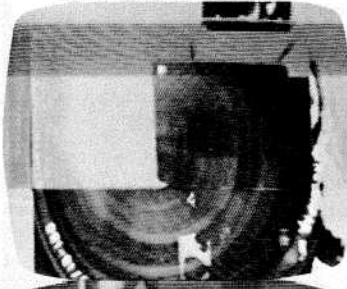
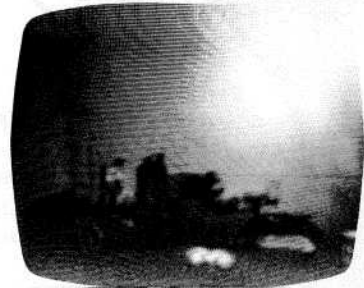
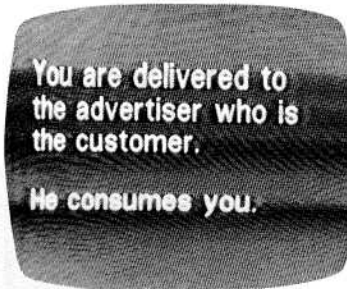

# CIRCUIT: A VIDEO INVITATIONAL

AT THE EVERSON MUSEUM OF ART, SYRACUSE, NEW YORK

**William Wegman**, New York  
Born 1941, Holyoke, Massachusetts  
Sonnabend Gallery, New York  
*Selected Works 1972* (30 min. B&W)

**Jud Yalkut**, New York  
Born 1938, New York  
A.I.R. Television Laboratory,  
WNET-TV, New York  
*John Cage's 26' 1.499"* as Performed by Charlotte Moorman and Nam June Paik (60 min. C)



Photos: Robert Lorenz/Design: David Hicock/Compilation: Judson Rosebush

# DOMESTIC COMMUNICATIONS SATELLITES

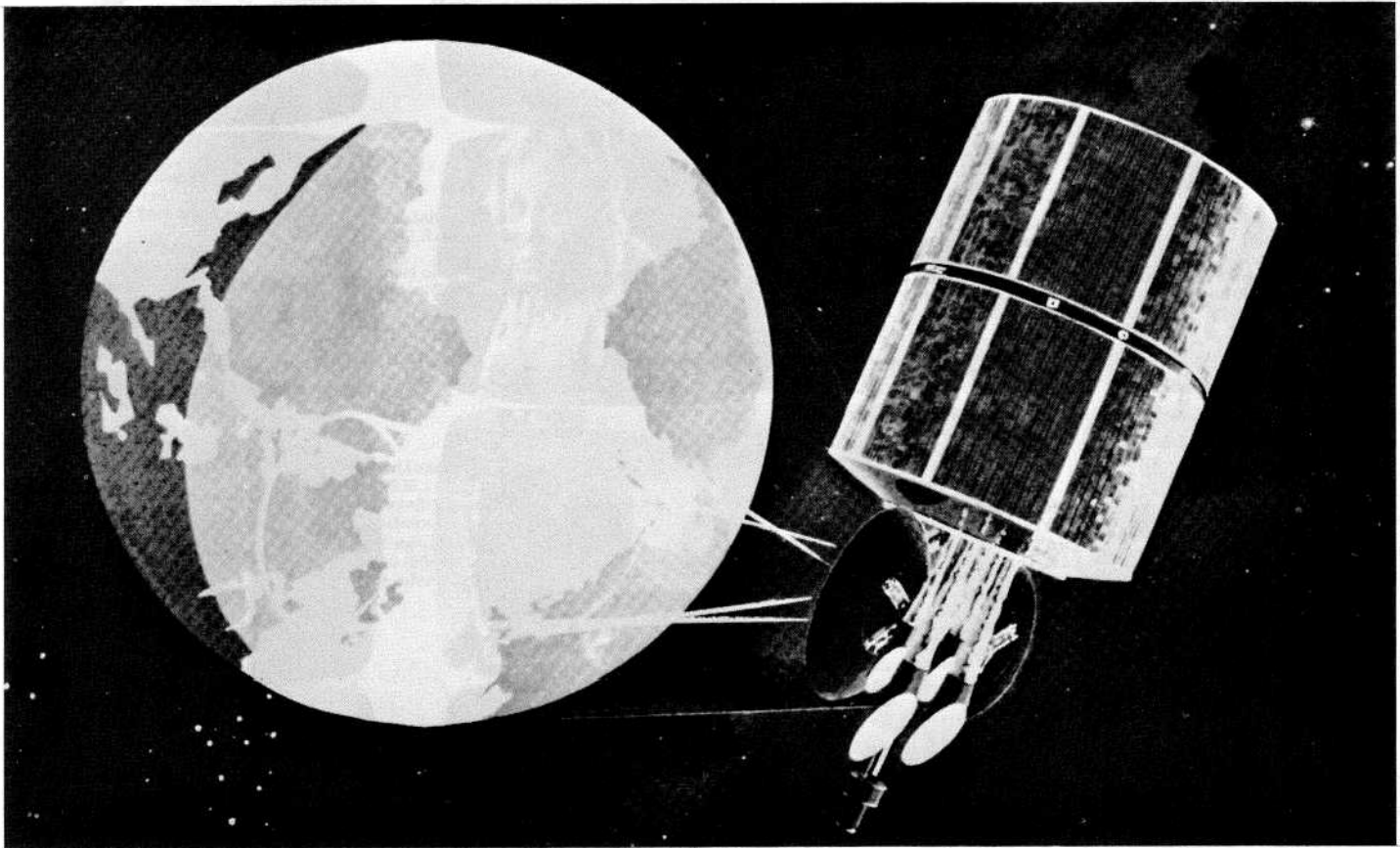

*On June 16, 1972 the Federal Communications Commission announced a landmark policy opening the way to the establishment of domestic satellite systems to serve television operators, telephone and telegraph companies, as well as add much to the national capacity for handling and transmitting data. The Commission's plan, which was initiated by the Nixon Administration in 1969 and subsequently the object of vigorous White House lobbying, is referred to unofficially as an "open skies" policy. It calls for almost no government regulation over satellite facilities that will be owned, operated and controlled by the nation's largest communications, aerospace and electronics firms: AT&T, GTE, RCA Globcom, Comsat, Hughes Aircraft, Fairchild Industries, Western Union Telegraph, Western Union International, and Western Tele-Communications. Not only does the policy provide these corporate oligarchs a sizeable public subsidy (communications satellites have been developed with more than \$20 billion in public taxes), but by facilitating the continued concentration of corporate control over the essential means of communications in this country, it effectively denies the public any role in determining the social application of one of the most powerful communications technologies ever manufactured. Further threat to public freedoms and rights is indicated by the fact that satellites are being considered by government and law enforcement agencies and private entrepreneurs to play an important role in carrying out various surveillance activities. The FCC's satellite ruling, as this article documents, must be viewed as a betrayal of public trust certain to have a far ranging impact upon American society and its earlier democratic principles.*

by Andrew Horowitz

When the British scientist Arthur Clarke predicted in 1945 that satellites would act as communications relay stations in space, a few took note. The idea that global satellites would interconnect every home and community in the world by telegraph, telephone, television, and data facsimile reproduction seemed a scientific fiction fantasy, as unlikely as radio and television broadcasting appeared to earlier generations of a pre-electronic age. But the Soviet Union's launching of Sputnik, in 1957, directed worldwide attention upon a powerful communications technology and the new frontier of space.

From this beginning it was believed that communications satellites would revolutionize the quality of human life and offer unprecedented opportunities for human improvement. Though this optimism persists, it has been tempered by the awareness that satellites can also be used to do enormous harm. Whether the domestic application of this technology will be used to serve people or concerns for economic and political power depends upon who controls and determines the purposes to which they are put. If the military and economic history of the communications satellite can be used as a measure for predicting future developments, it is less likely that the private control of this technology will be used to solve social problems than exacerbate them.

**Mr. Horowitz is affiliated with The Network Project, a New York based non-profit organization which conducts research-and-action on the structure, control and operation of American telecommunications.**

## A MILITARY AND ECONOMIC HISTORY

The communications satellite is a product of the Cold War, during which 94% of all federal research-and-development funds went to military and aerospace projects. The first worldwide satellite system, consequently, was the Pentagon's Defense Satellite Communications System, composed of 26 satellites in sub-synchronous equatorial orbit and supplemented by mobile transmitters that can be placed in virtually any terrain. This system has been used chiefly for what the Pentagon calls "tactical, or intratheater, communications" (i.e., support for its various counter-insurgency campaigns). The system's application in Vietnam, where satellites direct napalm strikes and artillery barrages, provides one footnote to the human use of modern technology.

A corollary to the military's interest in satellite facilities is its impact on the growth of the communications and aerospace industries. The Department of Defense, together with the National Aeronautics and Space Agency, has subsidized what today is the world's largest and most advanced aerospace, electronics, and communications enterprise by providing these industries with a guaranteed market for their product: in 1971, 32 electronics and communications corporations were among the top 50 industrial contractors. These are the firms now authorized by the FCC to establish domestic satellite facilities.

The firms seeking to establish domestic satellite facilities rank among the nation's leading defense contractors. Below is listed their defense rank and funds received, as well as the total assets of each company:

Company	<sup>a</sup> Rank <sup>a</sup> DOD	Contracts	<sup>b</sup> Total Assets
Lockheed Aircraft	1	\$1.5 billion	\$1.3 billion
AT&T	3	1.2 billion	55 billion
Hughes Aircraft	12	516 million	N.A.
North American Rockwell	13	478 million	1.5 billion
RCA	21	251 million	3 billion
GTE	42	106 million	8.6 billion
Collins Radio	60	72 million	417 million
Western Union Telegraph	65	66 million	1.1 billion
Fairchild Industries	76	49 million	188 million

a/ Aviation Week and Space Technology, November 22, 1971, p. 16.

b/ Moody's Industrial Manual, 1972.

The dominance of American aerospace and communications corporations has also been felt internationally in the area of commercial satellite communications. Prompted both by the military's achievements with this new space technology and the eagerness of the country's leading telecommunications firms to exploit its economic potential, Congress created the Communications Satellite Corporation (Comsat) in 1962; the Corporation's mandate was to establish a commercial satellite system that would improve international communications.

Comsat's contribution to the improvement of world communications is questionable; its service to the economic interests of its principal owners and users is not. The corporation's

earliest success resulted in the establishment of an international satellite system (Intelsat) made up of foreign telecommunications entities (83 countries are currently represented in Intelsat) that would share in the development of the system. An international partnership was hardly the point, however, with Comsat controlling 61% (now 52%) of the system and assuming its management. It has used its managerial position to divert the major portion of the system's contracts to American firms (98% in 1969)<sup>1</sup> and to expand the Intelsat structure at a rate profitable to the U.S. aerospace and communications firms. Whereas the Hughes Aircraft Company, which developed the first, second, and fourth generations of Intelsat satellites, has been Comsat's largest contractor, other manufacturers, including RCA's Globcom, AT&T's Western Electric, General Electric, ITT, GTE, Fairchild Industries, Lockheed Aircraft, etc. have benefited from Comsat's management of international satellites.

## THE CORPORATE INTEREST

It is not surprising, nor was it unexpected, that the communications satellite would become little more than a tool for increasing corporate profits. Those who foresaw this danger inherent in a privately owned global communications satellite system fought to preserve some form of public control over this technology<sup>2</sup>. But these voices were far outnumbered by those of the aerospace and communications equipment manufacturers attracted to a satellite system offering high profits and expanded international services. These interests have once again won a major political victory by obtaining from the FCC the exclusive rights to the ownership and control of domestic satellites.

There is no denying that domestic satellites will make money for their owners. The Stanford Research Institute<sup>3</sup>, in its detailed market feasibility study, conservatively estimates first-year satellite revenues (for 1975-6) of more than \$250 million, with each satellite entrepreneur anticipating revenues of between \$16 and \$69 million. This initial income is expected to come from the demand for a variety of new and old telecommunications services, including telephone, telegraph, radio, television, cable television, and private-line voice and computer data transmission. The Stanford study calculates that between 7 and 10 satellites (each costing from \$30-\$40 million) in synchronous orbit and about 240 earth stations (at \$1 million per facility) will be required to accommodate this traffic—a projected total investment of \$450 million for the first year of operations. By 1979, the system should be making more than \$800 million a year, with the greatest increase in service and income generated from the rapidly growing computer (annual growth rate of 30%) and private longline (annual growth rate of 13%) markets, as well as AT&T's picturephone service, soon to be introduced on a mass scale.

### Footnotes

1. O.W. Riegel, "Communications by Satellite: the Political Barriers," *The Quarterly Review of Economics and Business*, Vol. II, No. 4, Bureau of Economic and Business Research, University of Illinois, Winter, 1971.
2. See *Congressional Record* for 1962 as follows: July 26, pp. 13878-13879; July 22, pp. 13908-13909, 13911-13912; U.S. Congress, Senate Committee on Foreign Relations hearings on the Communications Satellite Act of 1962, Sen. Rep. No. 1973, August 10, 1962, 87th Congress, 2nd sess., Washington, D.C., 1962.
3. Stanford Research Institute, "Economic Viability of the Proposed U.S. Communications Satellite Systems," (contract No. OTP-SE-72-103), Palo Alto, Calif., 1971.

Those to be served by the owners of domestic satellite facilities also anticipate large monetary gains. The television networks, for example, expect to save \$45 million a year by using satellites to replace their reliance upon AT&T's terrestrial cable facilities to transmit programming. Satellites will also facilitate the economic plans of cable television operators to establish a nationwide system of interconnection.

This satellite enthusiasm is not restricted to the communications industry. In a recent *New York Times* advertisement,<sup>4</sup> the Eastman Kodak Company praises the new business opportunities opened by satellites outfitted with photographic surveillance equipment:

**The whole earth from a business viewpoint**

Aerial photographic surveillance started as an art of war. Now it has found work in helping mankind make a better peace with his environment. Kodak products, for example, monitor dangerous ice on the sea, as well as the health of lakes and the readiness of hillsides to slide down. Snow fields as fresh water sources are inventoried, as are fishing grounds off continental coasts.

Aerial photography also measures social phe-

nomena. Our color-infrared film has been found capable of providing accurate estimates of the number of families in areas of high population density. Statistics in the public library may lag behind population shifts. Business decisions require fresh, solid facts. We have customers who can pick economic facts out of the air—from an appropriate altitude. Decision-makers who wish to get in touch with such people should write Eastman Kodak Company, Dept. 928, Rochester, N.Y. 14650.

Similar advertisements conveying the many benefits that will result from the remote sensing of the earth by satellites, such as the General Electric ad that appeared in the *New York Times* entitled "Now let's make space technology the starting point for better ecology . . . better environment . . . better communications,"<sup>5</sup> have become commonplace. Such public-service claims by the manufacturers, suppliers, and procurers of the necessary hardware for aerial surveillance\* lead a responsible skeptic, aware of the history of satellites, to question whether this space technology will be adapted to an environment of peace or made to conform to a "business viewpoint." One prospective satellite owner, RCA Globcom, has already noted in its satellite plan to the FCC that it intends to make satellite facilities available to the mining and petroleum industries,<sup>6</sup> a market which that company believes will become a highly lucrative one. Regardless of the desirability of this service, it hardly deserves the industry-sponsored claims for improvements in ecology.

\*It is worth noting that the principal contractors for NASA's Earth Resources Technology Satellite, launched last July (1972) to identify sources of environmental pollution and monitor mineral resources, are General Electric and Eastman Kodak.

**CITIZEN SURVEILLANCE**

The application of satellites for environmental surveillance and land development, though suspect in the minds of environmentalists, may be far less threatening than if they are employed in the future to interconnect a nationwide system of policy and military surveillance. Yet, this Orwellian possibility was outlined in considerable detail in a report prepared by NASA and HEW for President Nixon's Domestic Council, called, *Communications For Social Needs*. This report focused upon how computers, closed-circuit television, and their interconnection via domestic satellites could be used to establish centralized personnel data banks controlled by state agencies and police departments across the country.<sup>7</sup>

4. *New York Times*, March 25, 1972.

5. *New York Times*, June 11, 1972.

6. FCC, "Domestic Communications—Satellite Facilities," *Federal Register*, Vol. 37, no. 56, Part II, GPO, Washington D.C., 1972, p. 5871.

7. NASA and HEW, *Communications For Social Needs: Educational/Cultural*, Washington, D.C.; The Domestic Council, August, 1971.

New York Times, July 24, 1972  
Earth Resources Technology Satellite

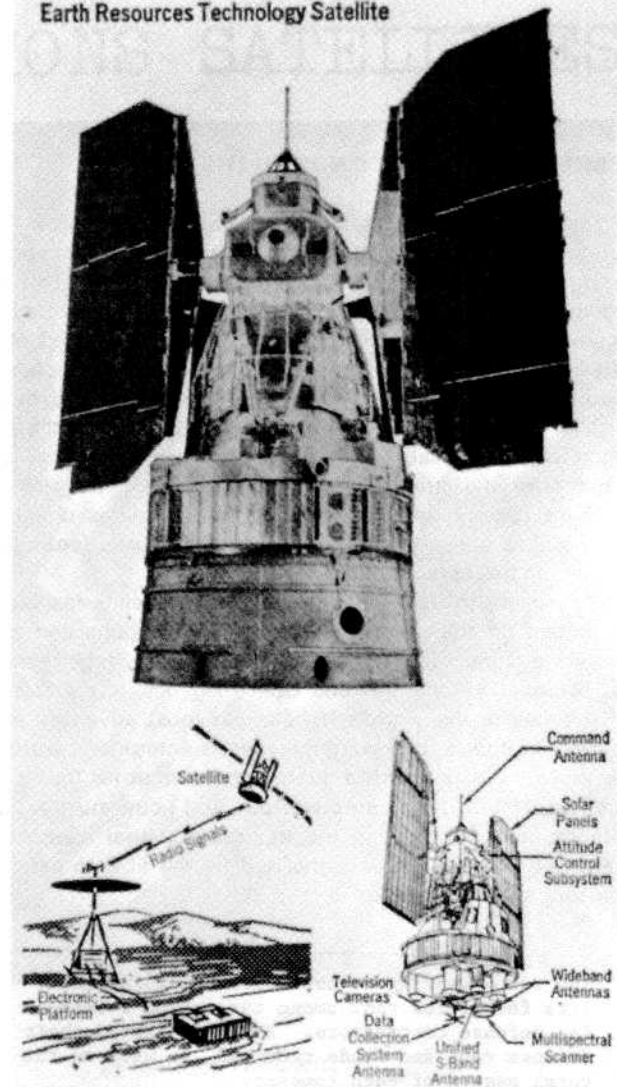

The New York Times/July 24, 1972  
Earth Resources Technology Satellite, its solar panels spread like butterfly wings to draw energy from the sun, is to scan the earth's surface for new information on the global environment and natural resources. About 150 automatic sensing stations like the one pictured at lower left are to gather and send to the satellite data about such factors as stream flow and soil moisture. Satellite then relays data to earth. Multispectral scanner and television cameras, placed as shown in drawing at lower right, pick up infrared and other electromagnetic waves reflected by earth features. This information is beamed to the ground for conversion into detailed pictures.

It is not difficult to imagine the creation of this citizen's surveillance system. The Pentagon has successfully used satellite communications along with laser and computer technologies in both foreign and domestic intelligence operations;<sup>8</sup> and its Advanced Research Projects Agency (ARPA), which coordinates university research, has established a coast-to-coast interconnected computer network giving scientists at MIT instantaneous access to data-banks built at Stanford.<sup>9</sup> Moreover, the FBI has established its own nationwide computer network containing dossiers on millions of individuals which the Bureau deems suspect. This network, known as the National Crime Information Center, coordinates more than 3000 computers located in police departments and state agencies across the country.<sup>10</sup>

Computers are only one of the many sophisticated communications technologies now in use by law enforcement

8. *New York Times*, October 16, 1971.

9. *New York Times*, April 15, 1972.

10. Arthur R. Miller, *The Assault On Privacy*, The New American Library, New York City, N.Y., 1972.



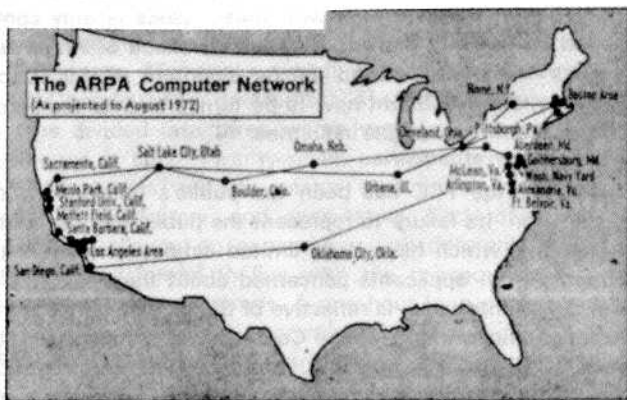

The Advanced Research Projects Agency (ARPA), a Defense Department research unit, hopes to have some 30 computer data centers operating in its nationwide network by fall. Usage is limited to university-related projects sponsored by Federal Government.

agencies. In New York City, for instance, television cameras mounted on helicopters relay pictures instantly to Police Headquarters or anywhere else on the department's closed-circuit network (Project Sky Knight performs a similar function on the West Coast, where police cars are now being equipped with individual computer programming and read-out terminals). In the event that prospective satellite owners choose to lease their facilities to government and law enforcement agencies for the interconnection of these and other surveillance efforts, they will do so in the absence of public consent. But given the recent Supreme Court decision upholding the constitutionality of domestic surveillance and intelligence gathering the public will have little to say about the introduction of such a communications network.<sup>11</sup>

### Television Camera Aboard Copter Helps Police Watch Traffic Here

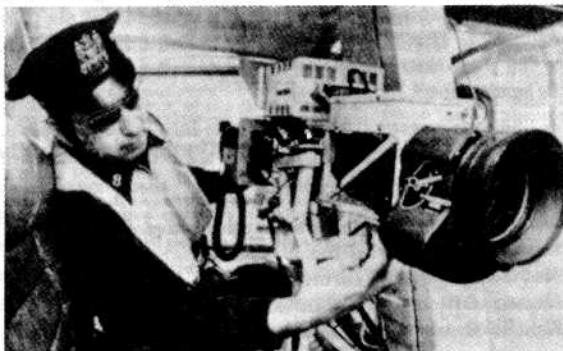

Patrolman Joseph Parla adjusting helicopter-mounted TV camera during demonstration



Patrolman Joseph Padrone checking the reception on monitor in Police Department van

## MEDIA CONTROL

Whether or not the private ownership of satellites will result in the application of these surveillance techniques is still a matter of some speculation; that it will add to the concentration of corporate control over the essential means of communications in this country is not. A close look at the developments currently taking place among prospective satellite owners reveals a number of new corporate alliances between those firms which control the technology used to manipulate the flow of information in this society and those that manufacture the equipment required to operate that flow.

Consider the recent formation of the American Satellite Corporation, a joint venture of Fairchild Industries and Western Union International. This corporate arrangement will join an established aerospace manufacturer and a long-standing agent of communications into a new communications enterprise. A less formal arrangement has been initiated by Western TeleCommunications, Inc., which intends to use satellites to expand its current 40,000 mile terrestrial cable television system to accommodate a number of new services, including data, computer and television transmission. The company has chosen the North American Rockwell Corporation (recently awarded the contract for NASA's \$2.6 billion space shuttle program) to design its satellites and coordinate their development, and selected the Collins Radio Company to supply the necessary terrestrial interconnections. The WTCI-North American-Collins Radio satellite plan may well become the nexus of a much larger communications corporate structure. If so, it will merely follow the example already set by Microwave Communications, Inc. (a consortium of 18 communications and electronics firms established in 1963 to transmit data and computer signals via a nationwide microwave relay system), Lockheed Aircraft, and Comsat. By mutual agreement these three firms created the CML Satellite Corporation which binds these parties into a tripartite corporate relationship; a team composed of an established satellite manufacturer (Lockheed), the world's most experienced manager of communications satellites (Comsat), and an expanding marketing firm (MCI).

Along with these mergers, the private ownership of domestic satellites will allow certain firms to assume virtual command of a communications process which includes not only the origination and distribution of information services, but also the manufacture of the equipment required to operate and maintain these services. Such will be the case for the Hughes Aircraft Company, which owns a sizeable share of the cable television industry (i.e., 49% of TelePrompster) and operates the Hughes Sports Network. Hughes' ownership of a communications satellite system will integrate its aerospace and communications plant with the production and nationwide distribution of television programs.

The most dramatic case of this phenomenon, however, is represented by RCA's Globcom Division, which operates an international telecommunications system with nearly 1,400 cable, radio, and satellite channels linking United States incorporated headquarters to their associates and subsidiaries in 78 foreign countries. The ownership of domestic satellites will expand this communications empire that currently ranks second in size only to the Pentagon's. Moreover, it will contribute to the economic and social power of its parent corporation, RCA. That conglomerate's subsidiaries already cover a wide expanse of the American economy—including RCA

11. *Laird v. Tatum*, Supreme Court, 1971.

Records, Banquet Foods, Coronet Industries, Cushman and Wakefield (one of the largest realtors in the United States), Random House (includes, in addition to its own imprint, Pantheon, Vintage, Alfred A. Knopf, Singer, and Modern Library), Hertz Rent-A-Car, and, not to be overlooked, the National Broadcasting Company.

The trend toward the centralized control of media, and consequently, the elimination of diverse sources of information, is considered by its benefactors to be the result of natural economic forces. When applied to the conglomerate control of domestic satellites, this development is supported by its owners in terms of improved communications and reduced consumer costs. But in the field which regulates the flow of information within society, economic standards alone are hardly adequate for determining public policy. The communications process extends well beyond economic boundaries; the information this process conveys shapes consumer tastes, molds the social and cultural environment, and directs political awareness.

More importantly, the institutions which operate the interrelated elements of the communications process (i.e., electronics manufacturers, program production companies, and interconnection firms) control what is essential to the citizen in a democracy, the right to be informed and alerted to any potential threat to his liberties. Where the control of this entire communications system is consolidated into those few but exclusive hands that are left unchecked to pursue their specialized interests, the public becomes the vulnerable party. Such is indicated by the failure of the media,\* particularly television, to inform the American people with respect to the social and political significance of the introduction of a domestic satellite system; nor has the citizenry been alerted to the varied misuses this technology might be put, including its use for such policing activities described earlier. The networks' direct involvement in the research and development of surveillance technologies, however, makes it unlikely that they would critically examine this important matter: RCA, which sold the United States Government more than \$250 million worth of military supplies in 1971, has perfected such surveillance equipment as the Three-Dimensional Surveillance Laser Technique for the United States Army; CBS has also engaged in similar efforts, including its development of the Laser Image Processing Scanners for the Air Force, as well as its Compass Link System of reconnaissance photography which has been adopted for domestic policing in numerous communities. Television's failure to report these major issues not only leaves in doubt the integrity and independence of this country's most revered medium of information, but more importantly, provides a clue to the limited interests which it serves.

## THE FCC?

No less disconcerting than the media's failure to alert the American people to the problems posed by the private control of domestic satellites is the way that the FCC has chosen to disregard its public responsibility. Throughout its satellite proceedings the Commission showed no concern for the effect its decisions would have upon the flow of information in this country, and chose to ignore entirely the question of how sat-

\*An exception was made by Mr. John O'Connor of the *New York Times* who in his May 21, 1972 column noted the problems posed by the corporate ownership of domestic satellites.

ellites might be used to erode essential public freedoms. The Commission's failure to deal with these issues is only compounded by the fact that more than \$20 billion of American taxpayers' money subsidized the development of this space technology, an investment now to be turned over to the aerospace and communications industries.

All along, the FCC has been the public's only means of representation. Its failure to represent the public in its satellite deliberations, which have been limited almost exclusively to arguments from applicants concerned about their share of a billion dollar enterprise, is reflective of the way powerful communications firms influence the Commission to accommodate private, at the expense of public, interests. One might consider the FCC's failure to regulate AT&T (which the Commission last year conceded that it has not regulated for decades) as symptomatic of its irresponsibility to the public; but its decision not to provide for some form of public control in the area of satellite communications represents a dereliction of duty, perhaps the grandest betrayal of the public interest in the history of American telecommunications.

**The Network Project does research in areas of telecommunication. This research is currently being made available through the project's publication of a series of six (bimonthly) *Notebooks*. The *Notebooks* are available by annual subscription (all past issues sent to late subscribers): \$10/individuals, \$25/institutions.**

**Individual *Notebooks* are also available: \$2/individuals, \$5/institutions.**

- No. 1: Domestic Communications Satellites**
- No. 2: Directory of the Networks**
- No. 3: Control of Information**
- No. 4: Office of Telecommunications Policy**
- No. 5: Cable Television**

***The Fourth Network*, a study of public television published in December 1971, is available for \$3.**

**Please make checks payable to: The Network Project Notebooks: The Network Project, 104 Earl Hall, Columbia University, New York, N.Y. 10027**

The Cooper-Hewitt Museum has organized a series of four computer-run urban games or exercises which probe various decision-making processes involved in urban development. In the first game, *Metropolis*, which was held in November at the IBM headquarters on Madison Avenue, a moderate-sized city was divided into three wards with fairly homogeneous populations in each. Twenty-seven participants were divided into three teams and the teams into three groups—politicians, administrators, and speculators. Each of the three groups was allowed to experiment with different strategies and then was forced to live with the consequences of its decisions in the next rounds. A one-hour long decision cycle represented one year of the community's life.

Five cycles of the game were played, and the participants could see the city shaped according to their decisions. The motives of each group determined construction, location of sewage lines and parks, tax rate. Outside events—national inflation, important quotas—were introduced by means of a newspaper and had a direct influence on the decisions.

The computer was used as an accounting device and to calculate such things as population growth, changes in per capita assessed value and public revenue, and the rewards and penalties for each of the roles.

An effort was made to assign the participants roles other than those played in actual life. The gaming experience was so complete that the reversal took place immediately.

Games have been used for more than a thousand years—Chess, Go, Shogi. They have been used by the military to analyze air and ground combat and new weapon systems and by corporations to study profit, new products, the performance of executives. Only recently has gaming been applied to urban problems. Now there are hundreds of games available which deal with urban finance, housing, transportation, waste disposal. Certain groups have games especially prepared for them.

The Museum has several reasons for organizing this series. When it re-opens in 1974 as the National Museum of Design, it will concern itself with design problems. Gaming is one effective way to examine design problems in that it forces one to think for the future. The Museum wants to introduce people to this technique. The Museum also believes that gaming and computer-run games can be adapted so that they can be used in establishing a dialogue between the Museum visitors and the museum exhibition.

John Dobkins



Speculator



Politician



Administrator

# ON GAMING

" URBAN COMPUTER GAMING "  
 A 50 min. video-tape by Juan Downey  
 Frank Gillette, Andy Mann shot at  
 IBM headquarters in New York City,  
 commissioned by the Cooper-Hewitt  
 Museum. Audio-visual engineering:  
 Juanfi Lamadrid

1. " Trouble arises" writes Gregory Bateson, "precisely because the 'logic' of adaptation is a different 'logic' from that of the survival and evolution of the ecological system". The purpose (goal, object, context) of the game is one of simulating ecologic and behavioral complexity ... of distinguishing the sets of relationship between, and the channels of influence exchanged by conceptions of the world and their subsequent control over behavior in the world.
2. The game is played by 3,6,9,12,15 or 18 people with a computer system which provides the constantly evolving context within which conceptual models are created and embodied in a range of media, from diagramatic print-out to holographic simulation. The system also provides the criteria by which models are tested.
3. A primary function of the game is the development of a variety of world-process orientations articulated or embodied in more and more encompassing contexts.
4. How does the game evolve models which separate the contingences of economic and social behavior from the bionomic contingences of the ecologic system in which the given behavior is a constituent part?
5. How does the game evolve corresponding values governed by a meritocracy of ecological description?
6. How does the game separate mythical attitudes based upon the successful domination of nature from conceptions based upon the successful interaction with natural forces?
7. LEXICAL POINTS OF DEPARTURE:
 

Sequential	Simultaneous, Topological
Linear	Atemporal
Historical	Ahistorical
Labor	Play
Acquisition	Access
Product, Goal	Process
Dualistic	Systemic
Continuity	Discontinuity
Enviromental Exploitation	Enviromental Enhancment
Ideological	Ecological
Static Image	Moving Image
Taxonomic	Simbiotic, Shared Dependence
Maximum	Optimum
Money	Information

8. Michael Apter\* pictures the structure of cybernetics thus:

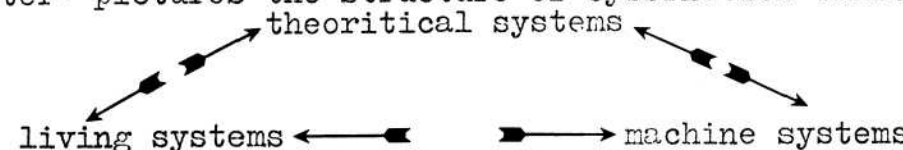

How does the game reflect the interactive flux between these structural elements?

\* Apter, M. The Computer Simulation Of Behaviour, Harper & Row, 1970, p.43

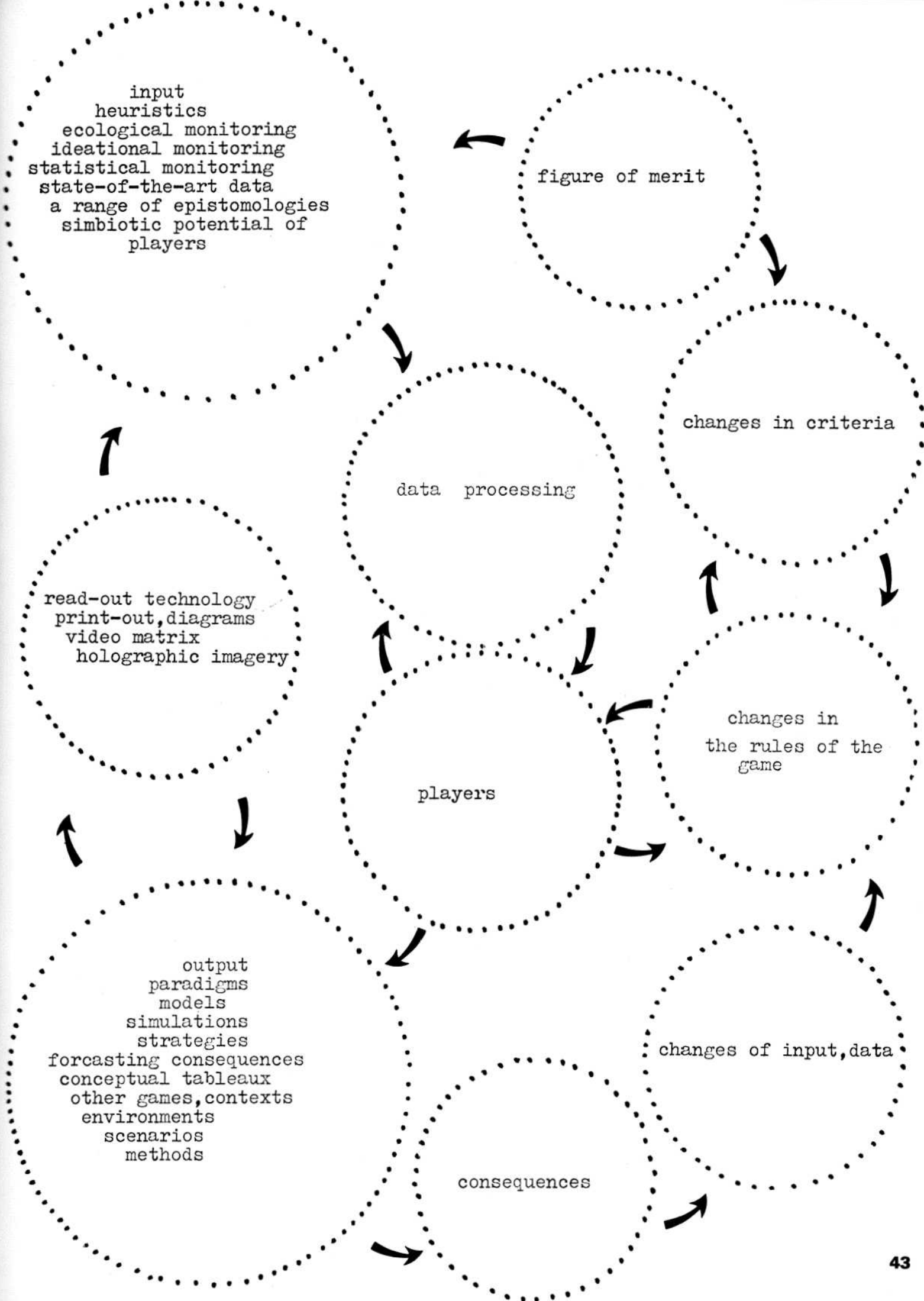

input  
 heuristics  
 ecological monitoring  
 ideational monitoring  
 statistical monitoring  
 state-of-the-art data  
 a range of epistemologies  
 symbiotic potential of  
 players

figure of merit

changes in criteria

data processing

changes in  
 the rules of the  
 game

players

changes of input, data

consequences

read-out technology  
 print-out, diagrams  
 video matrix  
 holographic imagery

output  
 paradigms  
 models  
 simulations  
 strategies  
 forecasting consequences  
 conceptual tableaux  
 other games, contexts  
 environments  
 scenarios  
 methods

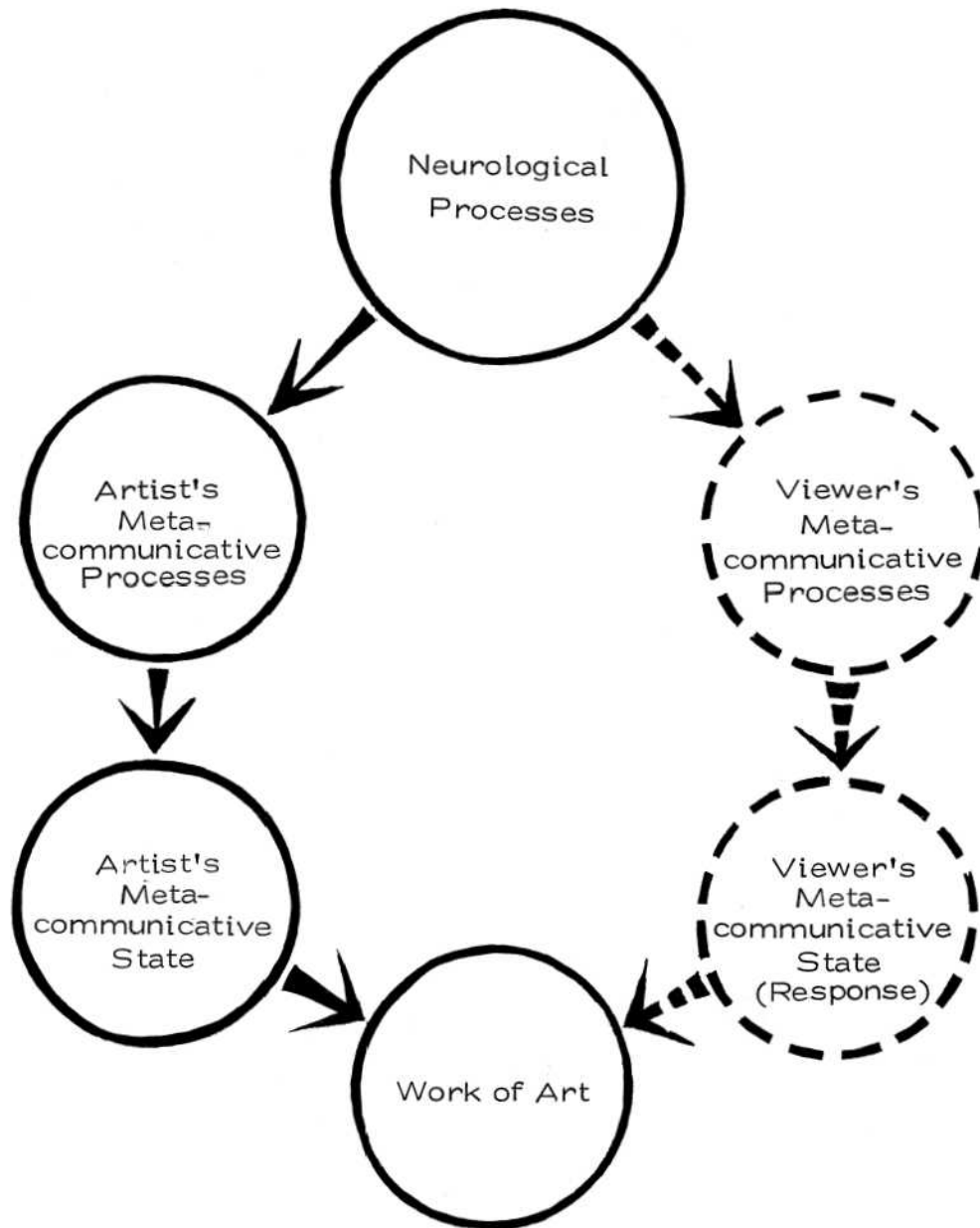

## BLUEPRINT FOR A CREATIVE REORIENTATION

By James Harithas

A work of art involves human processes and technologies which interact systematically; its purpose is to make visible a system by using an idea, action, event or object as a means of communication.

The assumption that the artist makes "something out of nothing" is crucial to an understanding of the creative act. In other words, this means that the creative act has its source in a meta-communicative process which is an internal pre-condition for creating and not subject to the caprices of memory.

This process begins with a closed system which one can perhaps analogize to the mind of the child before birth, and consists of neurological rhythms or vibrations whose source of energy is innate to the mind. (I. Rice Pereira theorizes that these resources are light radiation functioning at the nuclear level; another explanation is that they are electro-chemical or electro-magnetic changes.)<sup>1</sup> It is important to emphasize, contrary to the presupposition of a dichotomy of mind and matter, that the meta-communicative process is an integral part of nature like anything else. In the artist, it is a condition in which memory reverses itself, bypassing or clearing past experience and emotional debris, and reprograms itself on a new, synergetic level. The artist's mind is like an analogue computer functioning through changing programs. The metaphysical concept of rebirth also can be construed to be a kind of reprogramming.

The meta-communicative process gives access to a meta-communicative state, which relates to C. G. Jung's collective unconscious. This infolding condition reveals itself through a given set of expressive forms or symbols or through feelings.

Because modern western civilization discourages any profound concern with the inner-life, the artist protects himself by some ancillary behavior, which may be termed ritual integration, so that access to the meta-state is not accompanied by excessively abnormal or mentally dangerous stress or trauma. Either he recodes his behavior or withdraws emotionally for periods of time.

There is a parallel between John Locke's concept of mind as "tabula rasa" and St. John of the Cross' commitment to total faith; both are similar to the meta-state (as is the Buddhist Nirvana) and point to a kind of source condition which is the site of creative expression. In the artist, the mind's normally degenerating condition is reversed by the stable, negentropic effects of the meta-communicative state. Chemical meta-state, like those induced by LSD or Peyote, fall short of this experience to the degree that their disorienting effects trigger extraneous or entropic neurophysiological reactions.

While meta-state is the condition for creating and infuses the work of art with its own resonance or life-quality, it may or may not be content. We define content by the measurable forms which characterize the work of art, e.g., space-frame, time-pattern, color-structure; it is not the subject matter or message usually independently overlaid on content. Content is expressed through geometric and non-geometric configurations (for example, Tony Smith's polyhedral sculpture vs. Jackson Pollock's organic, overall skein-painting) and through processes obtained through advanced technology or through mental operations alone (Frank Gillette's multi-monitor video matrices vs. Bruce Nauman's conceptual, body events.)

Given the meta-processes and the tools, the artist transforms his own experience in or with nature into an appreciable work of art which is something more than a symbol, a model used to aid perception, a fetishe or a talisman. A work of art is the expression of a unified, finite system and as Paul Weiss correctly states; "... systems are products of our experience with nature, and not mental constructs. . ."<sup>2</sup> A system is composed of rule-governed elements. For example, the behavior of color is restricted by the geometric structures which characterize different artistic styles. A video image is restricted by the capabilities of the hardware and the informational approach of the artist.

Even so, this system—the work of art—is an entity still without a functional identity, i.e., it is art but without its full meaning as such. This can only be introduced into it by the spectator who instills meaning into the work of art through his response (feedback) to it—"validity is a function of belief." Response is simultaneously intellectual, i.e., aesthetic, historical, sociological; and emotional, i.e., pleasure, pain, joy. It is the psychological equivalent to what Norbert Weiner calls "control by information feedback."

Marcel Duchamp lives on. An art work not only involves the spectator in the final drama of its realization but makes him responsible for the last move. In this sense, the artist is medium, the spectator is message—and not an object of that message.

Since a work of art is an interface, a two-way communication between artist and spectator, then it too must be a cybernetic or informational discipline. Outside of Duchamp, this fact has been virtually ignored by art historians and aesthetic philosophers. For example, Susanne K. Langer's conclusion that art is "a final symbolic form making revelation of truths about actual life," idealizes the conceptual process and assigns a passive or reflective role to the spectator. This approach fails to accept the conceptual process as a prerequisite for content or the final work of art as a paradigm of interdependent, two-way actions between artist and spectator.

<sup>1</sup> Arthur Koestler and J. R. Smythies, *Beyond Reductionism*, Beacon Press, Boston, 1969, p. 10.

<sup>2</sup> Rice Pereira, *The Transcendental Formal Logic of the Infinite*, I. Rice Pereira, N.Y., 1966, p. 80.

*Editorial Note: James Harithas is the director of the Everson Museum of Art, Syracuse, N.Y. The following essay is taken from the Everson's Frank Gillette catalog which is available through the museum.*

# VT PROGRAM GUIDE

The following videotape listing represents a wide variety of recently produced tapes in regard to both form and content. These tapes are all 1/2" produced, though often edited on 1" equipment. In most cases technical standards are high.

Up to the present very few, if any, avant-garde or independent videotapemakers have succeeded in selling their tapes in any way that would come close to be considered economic support. In a questionnaire sent out to people included in this listing, we asked them to try and set prices for their tapes. The prices vary. The differences result from the amount of time people put into editing their tapes; whether or not they own their equipment or had to rent studio-time; and numbers of people working on a single production.

## DIMITRI DEVYATKIN

\* *Steep Turns*—(made Nov. 72) Computer animated, philosophical rap about spiral action in nature; music: Brahms violin sonata.

\* *Motown Edit*—(made Jan. 73) Computer animated, original paintings, very eye-holding; music by Temptations, Marvin Gaye, Smokey Robinson and Miracles.

\* *Sachdev Color*—(made Nov. 72) #3 animated thru computer, colorized.

*Sachdev Original*—(made Sept. 72) North Indian wooden flutist, with accompaniment by students, in California, 2 rags; excellent audio, 1 camera, with *John Rogers*.

EIAJ type M COLOR	30 min.	\$50 (rental) \$100 (sale)
EIAJ type M COLOR	30 min.	\$50 (rental) \$100 (sale)
EIAJ type M COLOR	25 min.	\$50 (rental) \$100 (sale)
1/2" b & w	30 min.	\$50 (rental) \$100 (sale)

\* computer animation with *Walter Wright*.

Other short pieces, plus tapes from the UN Conference on the Human Environment, Stockholm, 72, plus poetry and songs of American Hopi Indians, interview with David Brower, and many more, available from Dimitri Devyatkin, 324 East 19th Street, New York, N.Y. 10003.

## DOWNSVILLE TV

*Long live Life*—the events in and around Stockholm during the United Nations Conference on the Human Environment; going beyond the pollution problem.

*Friendly Farming*—About some people in Sweden who are rediscovering some basic approaches to farming by working with nature, not against it and the old man who is their inspiration and has much to teach us all about living on the earth and making things grow.

*San Francisco Oil slick*—Coverage of events which took place when two tankers collided in the San Francisco Bay spilling their oil and spoiling the beaches and wildlife. Focus: people really working together to repair their world.

*Downsville TV*—Collage of tapes which were shown over the local cable system made with and about the people of Downsville, N.Y., a small rural town in the Catskills. Includes technical information about how to hook onto the cable from a mobile van.

*The Rosebud Cafe*—A community organizes itself! This is a record of our experiences in getting together a community information/video access center in Delhi, N.Y. from the initial meetings with townspeople to video workshops, yoga classes, Saturday night jam sessions, and numerous other activities for young and old alike.

1/2" b & w	50 min.	Prices on request
1/2" b & w	30 min.	
1/2" b & w	30 min.	
1/2" b & w	30 min.	
1/2" b & w	30 min.	

For further information on these and other tapes (survival, environmental, community) contact April Video Cooperative, Box AK, Downsville, N.Y. 13755, 607-363-7432.

## ELECTRONIC ARTS INTERMIX

Tapes by **Juan Downey**:

*Bill*

*Laura*

*Doing Things Together*

*Plato Revisited*

1/2" AV b & w or 3/4" cassette	10 min. approx. 10 min. approx. 5 min. 30 min.	20 min. on one reel or cassette = \$150  \$150 (sale)
-----------------------------------	---	--



**Tapes by Frank Gillette:***Hark Hork! Etcetera*—72-73*Tortoise Templates*—71-72*Tetragramaton*—6 channel design (72-73) to be played simultaneously½" AV b & w;  
¾" cassette or 1"15 min.  
30 min.  
6 parts—  
25 min. each

All prices on request.

**Tapes by Andy Mann:**

EDITED AND UNEDITED VIDEOTAPES AVAILABLE ON LAND, SEA, AND AIR. VERY EXPENSIVE.

**Tapes by Eric Siegel:***Stockholm Visited**N.Y., N.Y.**Jerusalem**Amsterdam*½" AV b & w  
or ¾" cassette30 min.  
30 min.  
30 min.  
30 min.

Prices on request.

Members of Electronic Arts and Raindance collaborate. Further information on how to obtain these tapes, and information on other tapes made by these artists, may be obtained from Howard Wise, 2 West 13th Street, New York, N.Y. 10011 or from Raindance Foundation, POB 135, Ruby, N.Y. 12475

**HERMINE FREED***James Rosenquist*—artist interviewed in his studio and at work.*Larry Zox*—artist interviewed in his studio and at work.*Roy Lichtenstein*—artist interviewed in his studio and at work.*George Segal*—artist interviewed in his studio and at work.*Air*—20 tapes of women artists.½" b & w,  
or  
¾" cassette25 min.  
15 min.  
20 min.  
30 min.  
about 20  
min. each\$225 (sale)  
\$50 (rental)  
\$150 (sale)  
\$30 (rental)  
\$225 (sale)  
\$50 (rental)  
same  
\$50@ (sale)  
\$15@ (rental)

Interview with Lee Krasner; land project photo reportage of Robert Morris, New Paltz, N.Y.; and other art tapes and experiments available from Hermine Freed, 333 East 30 St., N.Y.C., N.Y. 10016 or from Leo Castelli Gallery, 420 W. Broadway, N.Y.C., N.Y.

**SHIGEKO KUBOTA***Europe half inch a day**Duchamp and Cage**Impasse of Infidelity**Riverrun*

½" b &amp; w

same  
same  
same4 channel playback;  
20 min. each20 min.  
30 min.  
20 min.  
4 channel playback;  
20 min. each\$15 (rental)  
\$60 (sale or if lose rental)  
same  
same  
\$60 (rental)  
\$300 (sale)

For further information on how to obtain these tapes write to: Shigeko Kubota, 463 West Street (951-D), New York, N.Y.

**METAMONKEY VIDEO**

*The Audience (1 and 2)*—a video repertory company offers two tapes exemplifying possibilities for video theatre. The first deals loosely with the theme of insanity, while the second involves death fantasies. Both evolve from the concept of metatheatre, an approach to acting which holds a special relationship to the presence of the camera. Shooting and editing are at a fairly crude level and the value of the tapes lies in what they reveal about the theatre potential of the medium. Humor is the dominant tone and the styles of the pieces range from Marx Brothers to Beckett.

*Audience (3)*—death tape

½" b &amp; w

#1—30 min.  
#2—17 min.

\$50@ (sale)

For further information write to Evelyn Honig or Marco Vassi, 14 Old Forge Road, Woodstock, N.Y. 12498.

**SUSAN MILANO**

*Tattoo*—documentary exploring modern day techniques of and attitudes toward tattooing through interviews with a tattoo artist, a plastic surgeon, a professional tattooed lady, and people on the street.

½" b &amp; w

27 min.

Price on request.

These and other tapes by Susan Milano may be ordered through Technivision, Inc., 215 East 64th St., N.Y., N.Y.

**NAM JUNE PAIK**

*Electronic Opera #1 or Excerpt from Medium is Medium*—produced by WGBH, Boston.

*Boston Symphony Video Variation*

*Selling of New York*—Nam June Paik (with Ed Emshwiller—though he prefers not to be credited)

½" AV 5000 color  
or cassetteany format ½"  
color or cassette6 min.  
7 min.  
7 min.\*prices on request  
same  
\*\*prices on request

\* Contact Dottie Chieasa at WGBH, 125 Western Ave., Boston, Mass.

\*\* Contact WNET TV Lab, 10 Columbus Circle.

**PORTABLE CHANNEL**

*Community of Witness*—During Holy Week of last year, theology students strung a chain around the Federal Building where the trial of the Harrisburg 7 was taking place, symbolically arresting the building to protest the trial and the Vietnam War. This tape is an inside view on the process of non-violent, religiously oriented, civil disobedience.

½" b &amp; w

27 min.

\$50 (sale)

<i>Homemade TV I</i> —A pilot we did last November with our local PBS station for a series which will use locally produced half-inch. It includes videotape segments of our experiences meeting old people: baking apple strudel at recreation centers, and in a nursing home.	29 min.	\$30 (sale)
<i>Ho! Ho! Ho!</i> —Rapping with a chauvanist Santa. (low light but people dig it.)	10 min.	\$15 (sale)

For information on other tapes—rental, purchasing, swapping—write to: Portable Channel, 308 Park Ave., Rochester, N.Y. 14607, 716-244-1259.

#### RAINDANCE FOUNDATION

<i>Fourth of July in Saugerties</i> —archetypal small town independence day celebration	All available on ½" and cassette	15 min.	These tapes are all parts of a ½ hour set=\$150
<i>Greatest Hits of the 80's</i> —delivery of <i>Radical Software</i> to the Raindance loft		9 min.	
<i>The Boring Years</i> —city/country		5 min.	

*Raindance Archive*—A series of tapes from the Raindance archive which include some of the earliest experimental works in video are now being edited. These tapes are primarily the work of Ira Schneider and Frank Gillette. They include environmental explorations of the *Woodstock* and *Altamont* music festivals (I. Schneider, 1969), the *Wipe Cycle* tapes and tapes of the show—**TV as a Creative Medium** (1969), the Antioch tapes (video experiments by F. Gillette and I. Schneider, Jan. and Feb. 1969), *Keep* (F. Gillette,—69) **The Rose Art Museum Show**—*Vision and Television* (1970), *Urban Environment tapes*, *Interview with Buckminster Fuller*, *The Rays*, *Solar Eclipse* (1970), *Clinton Project* (junior high school video workshop at Raindance Loft through Metropolitan Museum of Art, video profile of Saugerties, N.Y. (1973), collage/interview with metaphysician/architect Anne Tyng (1972), etc. Tapes in this collection also include the work of Beryl Korot, Dean and Dudley Evenson, Paul Ryan and Jud Yalkut.

For information on these and other tapes write to: Raindance Foundation, POB 135, Ruby, N.Y. 12475.

#### LYNDA RODOLITZ

<i>Marcel Cage-d with Jeanne Kerstein</i> —a performance of 3 piano pieces by Cage at the Martha Jackson Gallery show "Not Wanting to Say Anything about Marcel."	½" b & w Edited (AV3650)	31 min.	Prices on request
<i>Making a Hologram</i> —Eugene Dolgoff, an holographer, in his lab—a visit, an explanation.	½" b & w Edited (AV3650)	30 min.	

For further information write to: Lynda Rodolitz, 69 West 9 St., New York, N.Y. 10011.

#### VAN SCHLEY

<i>Airport Radio</i> —latest computerized airport information	½" or cassette	5 min.	Prices on request.
<i>Dogs and Sticks</i> —Dogs jump for stick		4 min.	
<i>Safari Land</i> —Drive through simulated animal park.		12 min.	
<i>Dogs' Dinner</i> —dogs eat dinner.		8 min.	
<i>L.A. Music</i> —Highlights of L.A. music shows off-air	color cassette	30 min.	
<i>L.A. Lakers</i> —Defending NBA champs being introduced.	color cassette	10 min.	

To purchase these and other tapes write to: Van Schley, Great Balls of Fire, 2622 2nd Street, Santa Monica, Calif. 90405.

#### WILLOUGHBY SHARP

<i>Videoviews</i> —Vito Acconci	½" and cassette	60 min.	\$300 (sale)
<i>Videoviews</i> —Joseph Bevys	½" and cassette	50 min.	\$50 (rental)

To purchase or rent these tapes write to: Willoughby Sharp Productions, 302 West 12th Street, 18F, New York, N.Y. 10014, 212-255-3804.

#### DANNY STEIN

<i>Death Be Not Proud</i> —video poem	½" b & w	30 min.	\$60 (rental)
<i>Ben Sidran Recording Session</i>	same	30 min.	\$60 (rental)
<i>Divinity</i> —Bette Midler in performance	same	30 min.	\$200 (rental)
<i>Stones</i> —Rolling Stones in concert in Indiana.	same	30 min.	\$200 (rental)
<i>Alexander tape</i> —conversations with a very young boy.	same	30 min.	\$200 (rental)

For information on other tapes, sale prices, etc., write to Danny Stein: 150 East 69th Street, 3A, New York, N.Y. 10021.

#### THE TEPEE—SHIRLEY CLARKE

<i>The Angels of Light</i> —(by Shirley Clarke, Hibiscus, and Angel Jack) Some mad, merry, musical moments from tapes made at the Experimental TV Lab designed to reveal how that favorite form of American entertainment—the musical comedy—can be given a new and unique form when it is interfaced in a "live" video mix with the possibilities of electronic color, chroma key, etc., to create some extraordinary, beautiful visual images.	2 ½" Panasonic color decks; also in b & w ½" Sony.	2 30 min. tapes	Sale only. Prices on request.
--	--	-----------------	----------------------------------

*The Vid-e-oracle*—(by Shirley Clarke and Don Snyder) a kit comes with each order for the Vid-e-oracle. The kit contains: 3 20 minute fortunetelling tapes, a set of instructions with helpful hints for would-be oracles; also 100 magic collage cards, chimes and bells, plus a headdress and robe for the oracle.

3 ½" b & w decks.

3 20 min. tapes

*Interface-Interplay: a Videotape Game*—(by Shirley Clarke, David Cort and the Teepee video troupe) First of a series of videotape games designed to interface with a live audience. Basic set-up: 2 ½ hour tapes each into separate decks into separate monitors placed side by side, played back together. Then as tape A plays back on tape B the same amount of space has been left blank to record a "live" camera interface with the playback. Cues to go into playback to record mode have been laid along with prerecorded material and blank space on both tape A and tape B so that you can play the inter-face-play game and the tapes are in a sense left unfinished in a manner unique and reflective of the imagination and ability of the people present.

2 ½" b & w decks and cameras.

2 30 min. tapes

For further information on the purchase of these and other tapes write to: THE TEPEE, 222 West 23rd Street, New York, N.Y. 10011.

### TOP VALUE TELEVISION

*Democratic Convention (1972)*

½" b & w

60 min. \$125@ for ½" (sale)

*Republican Convention (1972)*

and cassette

60 min. \$135@ for cassette (sale)

These and other tapes may be purchased by writing to: Michael Shamburg, Top Value Television, POB 630, San Francisco, Calif. 94101.

### THE ULTIMATE MIRROR, LTD.

*The Thing About Sculpture*—a conversation with George Nobl, the first of a series of programs about American artists living abroad. Shot on videotape at the artist's home on the Spanish island of Ibiza, the program provides a unique look into the creative process of a particularly gifted sculptor. The program is suitable for high school, college, or anyone with an interest in art, sculpture, or television.

master copy 2" high band videotape, 16 mm release prints, and ½"

14 min. 30 sec.

\$165 ½" (sale)

\$175 16 mm film (sale)

For inquiry of other tapes to purchase write to: Richard Rubinstein, the Ultimate Mirror, Ltd., 127 West 79th Street, suite 16B, New York, N.Y. 10024.

### THE VASULKAS

*Elements* (abstracts)

½" Panasonic color

10 min.

Prices on request

*Distant Activities* (abstracts)

12 min.

*Spaces Two* (abstracts)

15 min.

For information on the purchase and rental of these and other tapes write to: The Vasulkas, Woody and Steina, 111 East 14 Street, New York, N.Y. 10003.

### VIDEO EXCHANGE DIRECTORY

*Intermedia Sampler*—excerpts of tapes, 1969-71, by Vancouver artists' co-op.

½" b & w and cassette

25 min. Available free for exchange.

Prices on request.

*Tokyo (winter 71/72)*—research and experimental tapes by "Video Hiroba" access group. These include tapes of a marriage celebration, dance, music events, food events, etc.

½" b & w, color, EIAJ 1 & 2

3 hrs.

*Space Circus*—New York dance group

½" b & w and cassette

25 min.

*Ballet Horizons*—"Spectrum," choreography by Morley Wiseman.

20 min.

For further information about other tapes for sale or rental, and other groups in the Vancouver area write to: Mike Goldberg, Video Exchange Director/bottin video international, 358 Powell Street, Vancouver B.C., CANADA.

### VIDEOFREEX/MEDIA BUS

*Pitching a Tipi*—Darius Wood pitches a tipi and explains procedure.

½" b & w

25 min.

Up to 30 minutes=\$30 (sale)

*Whiz Bang Quick City*—Architects build a city in two days and stay two weeks.

30 min.

30 to 60 minutes=\$55

\**Quaking Aspens*—Program for four playback decks

4 tapes 20 min. each

(sale) including tape and postage.

*What's News?*—Television network broadcasters and journalists discuss what's news at the Republican National Convention, Miami Beach, 1972.

35 min.

*Jerusalem Mix*—A subjective view of rituals and customs. Shot in Jerusalem.

30 min.

Prices higher for CATV presentation

<i>Bart's Cowboy Show</i> —a jocular episode of life in the mountains for buckaroos and buckarettes from age 6 and up.	30 min.
<i>Lanesville Cable</i> —Introduction to a tiny but developing cable system. Provides viewers with a basic CATV vocabulary.	15 min.
<i>Video for Architects</i> —Basic application of portable video technology to the field of architecture. Includes video sight analysis and a visual examination of Reston Virginia.	15 min.
<i>Spaghetti City Video Manual</i> —A continuing series of tapes on repair and maintenance of portable video equipment:	
Basic electronic skills starring Dr. Electron . . . . .	25 min.
How to change a Video Head . . . . .	30 min.
How to clean brushes . . . . .	15 min.
<i>Lanesville TV; A Retrospective</i> —Documenting programs on Lanesville TV, probably America's smallest TV station.	30 min.

\* Special order of 4 reels.

Information about purchase or rental of these and other tapes available from: Videofreex, Maple Tree Farm, Lanesville, N.Y. 12450.

### VIDEOGRAPHE

<i>Hitch-hiking</i> (in English) by Frank Vitale (1972)—Un inventaire perspicace de la liberté dans le monde organisé, structuré des grandes villes. Par la biais d'un voyage sur le pouce, on pénètre peu a peu dans ce qui semble etre l'envers du quotidien, mais on le trouve a la traversée d'une frontiere, par une bible dans un motel et les éternels clichés de l'American way of Life. L'oeil impartial de la caméra constate simplement, avec poésie et humour que, pour retrouver une certaine liberté, il faut enfeindre les lois des hommes.	½" b & w	40 min.	Send empty tape and you receive free copy of the document
<i>Le Temps D'Une Priere</i> (by Jean-Claude Germain, Jacques W. Benoit, 1972)—Scénario de Jean-Claude Germain a partir d'extraits de morceaux de pieces de Sauvageau, Garneau, Germain.	½" b & w	30 min.	

Le temps d'une priere ou la débandade des curés.

Le mythe de l'amour éternel,  
de l'Eglise-mere qui résout tout,  
de la famille patriarcale unie,  
affronte la réalité des enfants d'aujourd'hui qui veulent la  
sainte paix, c'est toute . . .

For these and other tapes write to: Videographe, 1604 Saint-Denis, Montreal 129, Quebec, CANADA, 842-9786.

### VIDEOHEADS

<i>Leary Tape</i> —Telecine of a film Leary worked on in Switzerland.	½" American and European standard	45 min.	Tapes available on an exchange basis.
<i>Melkweg</i> —Facts and fiction about our home base in Amsterdam.		series of 30 min. tapes	
<i>Documenta 5</i> —Look at last September's Exhibition in Kassel, Germany.			
<i>Music Tapes</i> —Many of the concerts we've managed to tape over the past couple of years: Dylan at the Isle of White, The Dead, Zappa, Shawn Phillips.			

These tapes may be seen at the video-cinema of Melkweg—multi-media center in Amsterdam. For further information about purchase or exchange of these and other tapes write to: Videoheads, Postbus 6119, Amsterdam, HOLLAND.

### JANE AND WALTER WRIGHT

<i>Central Maine Power</i> —computer animation of a live performance by Central Maine Power Music Co., at the Kitchen, NYC (assistance by Shridhar Bapat)	½" Panasonic color	30 min.	Tapes are available for cost of tape stock and mailing charges, about \$12 for 30 min.
<i>Pulaski</i> —computer animation of a New Jersey industrial landscape		20 min.	
Tapes by <b>Walter Wright:</b>			
<i>Football</i> —computer animation of a tv football game.		30 min.	
<i>Gargantua</i> —computer animation of a tv movie.		30 min.	
<i>Paper Shoes</i> —computer animation interpretation of "Paper Shoes" by Yoko Ono.		10 min.	
Tapes by <b>Jane Wright:</b>			
<i>Christmas Mix</i> —interpretation of a family Christmas (3 channel version consisting of 3 related tapes also available)	½" b & w	30 min.	

*Cows*—interpretation of a farm scene (3 channel version consisting of 3 related tapes also available)

30 min.

Computer animated abstracts were done on the Computer Image Corp., Scanimate system. Color tapes are all Panasonic and people should state whether Sony or Panasonic deck is to be used for playback.

These and other tapes may be obtained by writing to: Jane and Walter Wright, 464 West Broadway, New York, N.Y. 10012 or c/o 330 Wedgewood Drive, Oakville, Ontario, CANADA.

**VIDEOMAKER—APPALACHIA'S LIVING NEWS-LETTER**

*A Mountain has no Seed*—Arden Franklin, Fentress County Tennessee farmer gives an eloquent and complete statement about strip mining while talking in his home and also by showing scenes of destruction around his home. Includes introductory material on stripping and the song, "A Mountain has no Seed" by Bill Christopher of Save our Cumberland Mountains.

½" b & w

27 min.

\$60 (sale)

*A Harlan Miner Speaks*—Tillman Cadle, a union organizer in Harlan, Kentucky during the bloody struggles of the 20's and 30's, talks of the famous Harry Simms killing, the life of a hunted union man, and other intimate stories of the period.

30 min.

\$45 (sale)

*I Would Have Gone Back*—Thousands of young men face charges of desertion from military service. The reasons stem as often from the complexities of mountain people as they do from the complexities of the military processes. Eddie Caudill of Fort Gay, West Virginia, tells of his own all too familiar journey from an E-5 wounded purple heart veteran of Vietnam to a deserter facing charges by the Army after confusion over medical treatment and red tape.

30 min.

\$45 (sale)

*The Union Struggle*—An edited overview of early union history in the mountains as told by the people who were involved.

1 hr.

\$100 (sale)

*In these Hills*—A brief view of mountain people and issues including portions of Hop Watts, Uncle Dan Gibson, Cabin Creek Miners, and Florence Reece singing "Which Side are You On." A good general introduction to the video resources available.

30 min.

\$60 (sale)

For further information on these and other tapes available for sale and/or exchange write to Ted Carpenter, c/o Videomaker, 132 S. Washington, Cookeville, Tenn. 38501, (615)-526-8410.



THE RAINDANCE FOUNDATION  
RADICAL SOFTWARE  
CHANGING CHANNELS  
BOX 135  
RUBY, N. Y. 12475



**Place:** Country Roadside, USA

**Scene:** Car loaded with video equipment en route to small rural college.

**Melanie Cable:** Stop the car!!! (Car screeches to a stop) You won't believe it but we've forgotten the take-up reels!

**Invisible Video Man:** I *don't* believe it! They don't have videotape equipment at Rural Community!

(prolonged silence)

**Melanie Cable:** Wait a minute! I've got an idea! Did we bring any *Radical Software* with us?

**Invisible Video Man:** Hmm, let's see ... I think I saw one under the seat. Yes, it's here ...

(They drive further down the road to a telephone booth. Invisible Video Man leaves the car.)

**Invisible Video Man:** Hello, operator, I'd like to place a call to Jeannette Cassette ... Hello, Jeannette, this is the Invisible Video Man. I'm on interstate EIAJ-1 with Melanie Cable en route to Rural Community when we realized we had no take-up reels. Do you have at least one

# SPARE REEL

**Jeannette Cassette:** Holy impedance! Invisible Video Man! Melanie Cable! Sure I've got some reels ... Hey, where'd you get my number?

**Invisible Video Man:** From the *Radical Software* video

# DIRECTORY

**Jeannette Cassette:** See you soon. (telephone clicks off)

So that you too can share in this network of exchange please fill out the directory form printed below and mail it to *Radical Software, POB 135, Ruby, N.Y. 12475*. Mike Goldberg of Video Exchange Directory would also like to hear from you, so mail a copy of this card to him at *Matrix, Vancouver Art Gallery, 1145 West Georgia, Vancouver, 5, British Columbia, Canada*.

For other *Directory* listings check-out *Radical Software* volume 1, #5, and volume II, #1.

PLEASE PRINT - EN LETTRES MOULEES, SVP

Name Nom	
Address Adresse	
Tél. ( <span style="font-size: small;">AREA CODE</span> )	
Equipment at your disposal Equipement à votre disposition	VTR use/interest Usage/intérêt vidéo
<div style="text-align: center;">← ←</div> <div style="text-align: center;">← ←</div> <div style="text-align: center;">1"</div>	<div style="text-align: center;">← ←</div>
<div style="text-align: center;">← ←</div> <div style="text-align: center;">1"</div>	<div style="text-align: center;">← ←</div>
CORRECTION OF LISTING	ADD MY LISTING

## ALASKA

**Mark Hinshaw**  
30-372 Cherry Drive #H  
Anchorage, Alaska 99506

New group forming, getting together to fight for access to cable and neighborhood head-ends. TIP: Local Sony people are looking for a good "tech" type and will pay good bread. Write: Northern Video Systems, 2328 Spenard Rd., Anchorage, Alaska.

## CALIFORNIA

**Environetic Synthesis**  
**Joe Cucchiara**  
**Richard Lowenberg**  
2430 Dwight Way #107  
Berkeley, Calif.

... Collaborative effort to develop and innovatively incorporate the newest information and technologies used in biomedical engineering, physiopsychology, computer-video display, electronic music synthesis, architecture, and environmental planning, within the framework of a comprehensive art-communication systems theory as applied to creating a greater harmony and understanding within the total human environment.

**John Antonelli**  
POB 148  
Bolinas, Calif. 94924  
213-868-0665  
Have CV 2100 and CV portapak.  
... into video verite.

**KVST-TV**  
1633 Westwood Blvd.  
Los Angeles, Calif. 90024  
213-478-0589  
Attn: Michael Colvin

"... is a community-controlled public television station, dedicated to the task of motivating people to participate in positive social action in community... 80% of our air-time will consist of locally oriented, hard issue public affairs programs directed toward community problem solving... presently seeking films and videotapes which document alternative solutions to social problems from outside the community to provide a broader perspective to the search for solutions to local problems..."

**One World Television Liberation**  
**A.I. Goodman**  
19130 Pacific Coast Highway  
Malibu, Calif. 90265  
213-456-2695

Have 1/2" CV 2200 camera and lens. Began experiments in the Fall, 1968. Tapes for sale at \$1/min. are 1) *Reassociative Electronic Art Forms* (45 min.) and 2) *The Barn that was a Video Commune* (60 min.).

**Fredric R. Cole**  
305 West Clark Ave. Apt. #B  
Orcutt, Calif. 93454  
815-925-3388

Equipment: 1/2" 3400, 3650; Sony cassette; 1" IVC700 and 860; 2 Ampex cameras; switching board and studio at Teleprompter CATV of Santa Maria.  
Focus: CATV/Access/Video as Art/work-play experiments...

**Jeffrey R. Davis**  
Shasta General Hospital  
Outpatient Services—Program Development  
2630 Hospital Lane  
Redding, Calif. 96001

"We have initiated in Shasta County a program titled *Community Feedback: Two-way TV* which attempts to encourage consumer participation in community affairs via an opportunity to call in or be present to discuss social issues pertinent to the present scene in Shasta County... new ideas, techniques welcome..."

**Philip Bowles**  
3410 Jackson Street  
San Francisco, Calif. 94118  
415-346-3324

Personal and sometimes professional use of 1/2", 1" and 2" equipment over past 4 years. Available as a camera person and technical helper if given advance notice.

**Gay Video Artists**  
1887 Page Street  
San Francisco, Calif. 94117

Planning a gay video workshop as the preliminary step toward the formation of a production group.

**Queer Blue Light**  
Gay Video San Francisco  
POB 4277  
San Francisco, Calif. 94101

A group of gay people active in the gay liberation movement, working with 1/2" video to develop the social consciousness of the gay community and to educate the public in order to end the oppression of homosexual women and men in this society. Tax-exempt. Non-profit.

**Video California**  
**Jon Beckjord, et al.**  
Box 26345  
San Francisco, Calif. 94126

Have Sony 1/2" portapak, AVC 3200 DX camera, a color and b&w monitor, plus VO-1600 Sony Videocassette recorder/player (3/4" color) plus access to other recorders for duping and transfers, plus access to film chains.

"We are film and videotape makers who support our efforts by selling new and used portapaks, tape, videocassette equipment, etc. We also arrange for videocassette hook-ups for apts., bars, hotels... using the best available software—abstract tapes, ski films, surfing films, erotic films, football, computer films, short films and tapes, etc. We hold weekly Wednesday night open video screening for video freaks and others... Y'all come. 8 pm."

**L.A. Public Access Project**  
1817 Stanford Street  
Santa, Monica, Calif. 90404  
213-828-9800

All kinds of 1/2" equipment, though not enough.  
... program for public access and cable and community ownership.

**Victor Stoloff**  
15339 Weddington Street  
Van Nuys, Calif. 91401  
213-789-1982

Have 1/2" Sony 3650 and Concord. Research as writer/producer/director of feature film and tv.

## COLORADO

**Thomas B. Cross**  
Municipal Building  
Boulder, Colorado  
303-442-2020

... research in the area of urban telecommunications design and the municipal approach to cable communications.

**Bill Pratt**  
Denver Community Video Center  
1400 Lafayette Street  
Denver, Colorado 80218  
303-573-1062

... trying to develop a facility to implement community tv production through 1) workshops; 2) technical resource for community tv production and 3) information resource on cable tv and community tv.

## CONNECTICUT

**Bill Shanahan**  
578 East Street, South  
Suffield, Conn. 06078  
203-668-2774

... planning on doing community oriented programming for future use on local cable systems.

## FLORIDA

**The Video Center**  
247 University Union  
Florida State University  
Tallahassee, Florida 32306

A video co-op initiated within the Center for Participant Education (CPE), operating under their auspices as a free educational experiment. Have Sony AV3400, 2650, 3600 and access to other 1/2" systems. Through audio-video section of university library tapes are available for individual viewing; through Union Resource Center there is a primeval digital information command retrieval system open 24 hours; there is also a mass viewing space. Most important, in cooperation with Clearview cable station in Tallahassee a Citizen's Committee on Cable is forming. The desire is to expand the co-op beyond Tallahassee to tape exchanges with other video co-ops around the globe.

## HAWAII

**Kamehameha Early Education Project**  
Attn: Larry Loganbill  
The Kamehameha Schools  
Honolulu, Hawaii 96817

Seeking information or experiences of others who have worked with kindergarten kids in exploring the potentials of videotape to help them learn how to learn.

## ILLINOIS

**Vitronics, Inc.**  
Attn: Richard W. Crandall  
417 West Kay Ave.  
Addison, Ill. 60181  
312-543-5150

Have 1 IVC 960 1"; 2 Shibaden Plumbicon cameras. Have studio, do business and industrial training; willing to explore new areas. CATV also.

## Humvideo

Attn: David Affelder  
Box 1, The College  
University of Chicago.  
Chicago, Ill. 60637  
312-753-3380

Have 1/2" Sony: 3600, 3650, two 3400's.  
Have access to SEG 1 and SEG 2.

Purpose: To promote the use of vtr in Humanities teaching, for student projects, for special projects not academically related, but concerning videotape. Projects: "Steamboat Julia Bell Swain"—a documentary about one of the last steamboats around; "Sit-In"—documentary and comment on the Sit-In of 69 that swept the campus; the tape is being presented as a spur to student-administration dialogue. Numerous process tapes on teaching in the college acting and dance groups, several political meetings.

## Mass Communications Dept.

Dave Brown  
Box - 73  
Southern Illinois University  
Edwardsville, Ill. 62025  
618-337-9016

Have limited access to Sony 1/2" AV 3400 and AV 3600, but are taking steps to get Concord equipment of all kinds.

"... We are a loosely knit group of Black Communications students working with 1/2" video equipment on a part-time basis. Most of work so far has been learning to use the equipment and teaching others to do the same. We are ready to set-up a Videography workshop and are seeking funding ..."

Richard Daniels  
POB 608

Salem, Ill. 62881  
618-548-0540

Own an Akai 1/4" portapak. Have some tapes of rural southern Illinois life with its quaint customs. Want to hear from other 1/4" users. Also have invented an interesting practical modification of the Akai portapak.

## INDIANA

Chuck Pine, Engineer  
Video Access Center  
Franklin Street  
Columbus, Indiana

## KANSAS

Darrell Humphrey  
7300 State Ave., Apt. 801  
Kansas City, Kansas 66112  
913-334-0481

Have 1/2" 3400 and 3650. Also 1" Ampex 5800, 7800, 5200, and complete color studio in Lawrence, Kansas. Educating the public about Public Access CATV. Equipment access through University of Kansas and Sunflower CATV in Lawrence, Kansas. Starting video co-ops in Kansas City and Lawrence.

## LOUISIANA

Stephen Duplantier  
Urban Semiotics Project  
4712 Palmyra Street  
New Orleans, La. 70119  
504-488-2474

Have 1/2" portapak.

New Orleans is being explored systematically through video. "Urban Semiotics" is what is being discovered. Theoretical orientation is a series of cross-level hypotheses of general system theory.

## MARYLAND

Catalyst Inc.  
5259 Brookway  
Columbia, Maryland 21044

Setting up as a video exchange network especially for tapes dealing with the environment and ecology.

## MASSACHUSETTS

Mystic Vision  
Harvard Divinity School  
45 Francis Ave.  
Cambridge, Mass. 02138  
Attn: Barrett J. Bilotta  
617-492-5509

Have 1/2" Sony.

Use vtr for a sociological mirror, gestalt learning, and ethnographic video. Will be exploring all the electronic media as a means for attaining higher states of consciousness. Also concerned about community control and access to cable tv.

Video Works  
Vocations for Social Change  
353 Broadway  
Cambridge, Mass. 02139  
617-661-1570

... have extensive tape library inherited from Mission Hill Video and FUNE Video, both of which have ceased to exist. Are putting together tapes on the meaning of work and work collectives. Are available for video workshops. Write to them for extensive tape listing.

Dennis Allen  
Walter Henritze  
6 Norwood Street  
Worcester, Mass. 01610

Have access to Sony portapak (AV), 3650, 3400 decks, Cramer Mark IV Porta Studio (Shib cameras, Shintron switcher), Sony CV portapak, Old Ampex 1" deck, Ampex turret three lens camera.

Need technical consultation or interested technical person to work with.

## MICHIGAN

Norman P. Johnson  
742 South Division  
Ann Arbor, Michigan 48104  
313-769-2221

Have AV 3400 and 3650; also 1" IVC, 901 cameras and projectors.

... video magnification for large musical events; also, into producing counter-culture tv shows and advertising.

## Cerberus Video

1008 Pontiac  
Ann Arbor, Michigan 48105  
313-769-7582

... much concern with real-time video configurations; performed works of dance and large screen projection of live and delayed video mix; also, multi-monitor presentations ... will conduct workshops in schools and institutions to help develop software for those interested in maximizing their existing video resources and potential.

Community Cable Coalition  
Martha Wade or Sonny Cohen  
627 South Division  
Ann Arbor, Michigan 48104

... formed to develop, discover, delineate resources and processes necessary for public production of programs cablecast on the education channel of cable tv in Ann Arbor, Michigan. Presently organizing information on books, periodicals, pamphlets, letters, documented experiences, list of individuals knowledgeable in various aspects of CATV. Your help is welcomed.

Vidipax  
1172 Eagle Lake Drive  
Kalamazoo, Michigan 49009  
616-375-2371

Have two Sony 1/2" portapaks and access to other 1/2" and 1" equipment through Kalamazoo Valley Community College, Western Michigan University, and the Sound Room in Kalamazoo.

... Been working to set up a community video access and video workshop utilizing portable 1/2" equipment. Recently been experimenting in the area of self-processing and video feedback loops.

Video Feedback, Inc.  
POB 112  
Troy, Michigan 48064  
313-645-0035

Have portable equipment, editing equipment, cassette, and color IVC.

... into documentation, political education, creative expression, survival, etc.

## MINNESOTA

Winona Video Group  
POB 948  
St. Mary's College  
Winona, Minn. 55987  
Attn: Dan Spiess

... educating the community of Winona concerning the renewal of their cable franchise. This entails writing up a new franchise, programming video for the community, training the community to use video backpacks and becoming an information center in Winona. Interested in tape exchanges and correspondence with other groups involved in similar activities.

## NEW JERSEY

R.B. Hayes Telly Squad  
c/o Dave Martucci  
69 Crater Avenue  
Wharton, New Jersey 07885  
201-366-9450



Have portapak, editing deck and accessories. "We are a group of Northern New Jersey Suburbanite Freaks who got into video because of a great dislike of what broadcast tee vee and our local cable station pawns off on us as entertainment and education. We're just starting out. Tape exchanges, correspondence with others desired, especially concerning gaining access to local cable."

**Spring Child Productions**  
**POB 702**

**Atlantic City, N.J. 08401**

"... a non-profit organization formed to assist talented people in developing their skills. For the past four years we have been producing shows for local tv in which we integrated professional and non-professional talent. At present developing a format for an alternative to standard television talent show; to be videotaped on 1" as a pilot to raise funds to complete this project and implement others in the community ..."

**NEW YORK**

**Columbia Greene Community College**

**Attn: Cliff Wexler**

**2 First Street**

**Athens, New York 12015**

**518-945-1850**

Have 1/2" equipment and make tapes in the local community. Interested in showing students the videotapes of other groups. List of tapes welcomed for possible sale or exchange.

**Lenny Schneiderman**

**217-12 64th Ave.**

**Bayside, N.Y. 11364**

**212-631-2148**

Has Access to CV 2100, AV 3400, AV 3650 (all Sony); plus Sony 3/4" U-matic cassette. Also, Sony 1" EV 320, IVC700 C, and IB-5 Scan Converter.

**Brooklyn College Television Center**

**Attn: Jeffrey Nagler**

**Whitehead Hall**

**Brooklyn, N.Y. 11210**

**212-780-555-6-7**

**Arnold Klein**

**3411 Flatlands Ave.**

**Brooklyn, N.Y. 11234**

**212-258-0800**

Has Sony and Panasonic 1/2" equipment. Into video communications planning and research; CATV, public access programming; viewing and access centers. "live" local origination for community information systems, new technology for the arts.

**Pacer Video**

**350 Ave O**

**Brooklyn, N.Y. 11230**

**212-375-1911**

Involved in video for entertainment, educational and community usage.

**Cliff Wexler**

**Video Abraxas**

**POB 192**

**Germantown, N.Y. 12526**

Have 1/2" Sony equipment. Operate a videotape service for local community. Conduct workshops at schools. Working on videotapes for local CATV and distribution.

**Dowling College**

**c/o Ned Bobkoff**

**Oakdale, N.Y. 11769**

**516-LT9-6100**

Involved in theatre which incorporates video and video environments to expand dramatic context.

**Atomic Video Network**

**Michael Luckman**

**Suite One**

**134 West Houston Street**

**New York, N.Y. 10012**

**212-260-2799**

Uses 1/2" equipment to develop and distribute video for progressive social change for college and university markets, and to produce syndicated entertainment programs geared to the underground.

**Ari Kiev, M.D.**

**Social Psychiatry Research Institute, Inc.**

**150 East 69th Street**

**New York, N.Y. 10021**

**212-249-6829**

Have 1/2" Sony and Panasonic VTR Rovers with special effects.

Tape lecture demonstrations on social and psychiatric problems using material from clinical and psychiatric problems and from clinical and community settings—for use by professional and lay audiences. Subjects include depression; suicide; drug abuse; stresses of modern life; strategies for daily living.

**The New York Public Library**

**Young Adult Services**

**8 East 40th Street**

**New York, N.Y. 10016**

**Attn: Emma Cohn**

**212-790-6466**

Have 1/2" Sony portapak; 3650 playback and editing deck.

Conduct teenage videotape workshops and other video activities involving young people in the branches and centers of the library.

**New York Switchboard**

**133 West 4th Street**

**New York, N.Y. 10012**

**212-533-3186**

One of their many services to the Village community is videotape productions on community issues and anti-war activities. These are shown at various workshops and on public access TV. Have produced 2 hour long programs and 11 half hour programs.

**Video Access Center**

**528 Laguardia Place**

**c/o New York University**

**New York, N.Y.**

**212-598-3586**

... have 4 3400 portapaks, 1 SEG 1 modified, sound equipment, 1 3600, 2 3650's, 8 monitors, 1 synthesizer/colorizer/monitor, 2 studio cameras.

... with equipment, tapes, and repairs provided by Sterling Manhattan Cable, the center provides equipment on a project and individual basis to their community. The purpose is to provide the opportunity for individuals and community groups to make tapes available for public access viewing.

**Beth Bodenstein**

**12 Terryville Road**

**Port Jeff Station, N.Y. 11776**

**516-928-5449**

Have 1/2" Sony 3400, 3600, 3650; also 1" IVC.

... into educational use for med school at Stony Brook campus, SUNY. Also, conduct workshops for university community to get people to listen/see each other and learn.

**Walter A. Dale**

**VTR Project Director**

**Port Washington Public Library**

**Port Washington, N.Y. 11050**

**516-883-4400 Ext. 45**

Have 2 Rover portapaks; 1 AV 3600 and 1 AV 3650 Sony decks; also 2 EV 634-A mics.

Developing vtr as a citizen production access center within the institution of the library. Emphasis is on people—programs by, for and of people. Over 300 hours of citizen produced programs.

**Marc Cutler**

**7 Archer Lane**

**Scarsdale, N.Y.**

**914-723-1259**

Have 1/2" portapak.

... interest in exploring alternative urban environments. Currently working in a program at Antioch College related to Paoli Soleri.

**Neighborhood Report**

**Tom Klinkowstein**

**416 West Onondaga Street**

**Syracuse, N.Y. 13202**

**315-473-4641**

Have 1/2" portapak, 3650, complete print facility including IBM MTST.

... produce monthly community news-magazine. Also do video and broadcast tv, usually in the form of a city tv magazine. Have good working relationship with broadcast channels, so have been able to put 1/2" through the air.

**OHIO**

**Richard Bishop**

**9100 Bellefontaine Road**

**New Carlisle, Ohio 45344**

Has access to equipment through Wright State University. Has portapaks, AV 3600's, 3650's; 1" color production facility with 2 cameras, 3 vtr's, film chain, special effects.

Trying to free the use of video for creative expression from Communications Dept., control which sees video as only useful to potential commercial broadcaster. Also trying to input creative notions of video in the development of cable tv in the Dayton area, where a national training school for cable television is being formed by a local consortium of schools of which Wright State U. is the central member.

**OREGON**

**Bill Bradbury**

**POB 641**

**Bandon, Oregon 97411**

**503-347-3518**

Have AV 3400 and 3650 Sony decks. Also 2 monitors and Buchla Audio Synthesizer and Sony mixer.

... into: 1) grass roots organizing centering around local land use planning (zoning); 2) improving information quality in government decision making (i.e. presenting well crafted tapes, dense information, to Oregon Coast Conservation and Development Commission showing environmentally fragile areas and encouraging decision making about the future); video electronic imagery; mixing video imagery and sound traces generated on Buchla. Currently shooting natural abstract patterns.

**Environmental Education Center**  
**Portland State University**  
**Portland, Oregon 97207**  
**503-229-4682**

Using portapak to explore environmental problems. Introduce people to the equipment and then help them develop goals for its use, program materials, and program distribution.

## PENNSYLVANIA

**WPCP**  
**Work Peacefully: Communicate Patiently**  
**c/o Stephen Waterman**  
**624 South 4th Street**  
**Philadelphia, Pa. 19147**  
**215-928-1430**

Have two 1/4" Akai portapaks and one Sony portapak. Sound: Nagra IV, Revox taperecorders, misc., mics and mixers. City planning tapes, self-processing; local news; community communications.

**Tom Thompson**  
**Smith, Kline and French Labs**  
**1500 Spring Garden Street**  
**Philadelphia, Pa.**  
**215-LO4-2400 Ext. 566**

Have Sony portapak, AV 3600 and 3650 decks; EV 320; Gross Valley Proc Amp Switcher; Gross Valley Sync Generator; Gen Lock.

... do a weekly corporate news program and some training tapes. Interested in community programming and the technical esthetics of the medium.

**Video-Space**  
**126 Humes Alley**  
**State College, Pa. 16801**  
**814-237-5031**

Have 2 AV 3400 portapaks; 1 AV 3650 editing deck and accessories.

... dedicated to experimental investigations of the psychic and social effects of television as well as the artistic qualities inherent in the medium, and will provide facilities for video artists ... also an organization designed to encourage individual and public awareness of television and its applications—will provide production facilities and consultation for public access use.

## RHODE ISLAND

**Alan Powell**  
**Rhode Island School of Design**  
**Box 1012**  
**2 College Street**  
**Providence, Rhode Island 02903**  
**401-272-4305**

Have CV and AV Sony portapaks. Interests: videoart; documentary; working experimentally in multimonitor situations to realize video as a sculptural and environmental medium.

## WASHINGTON

**Dan F. Barr**  
**2046 Westlake North**  
**Seattle, Washington**  
**206-285-1101**

Have 1/2" Panasonic portapak, 3020 deck. Use video for personal growth, bioenergetic feedback; interpersonal process recall counselling, etc.

## WISCONSIN

**People's Video**  
**1127 University Ave.**  
**Madison, Wisc. 53715**

... a collective of men and women taping things of particular importance in Madison—especially local strikes, community organizations; overall—survival and social change ... the tapes are an attempt to reflect and improve our environment; document and control our communications; build towards community awareness. Programming for cable; working to generate new video groups by creating an access center.

## AUSTRALIA

**Bush-Video**  
**31 Bay Street**  
**Ultimo**  
**Sydney, Australia**

... "if you want to turn people on to the detail of your trip ... make a videotape about it ... priority goes to tribal groups ... come in and do your own live newscast ... we will teach you how to use equipment ... we can feed each others heads with placenta of the mind thru the electric umbilical cord."

## CANADA

**Willy Wilson**  
**254 Wellington St. E.**  
**Sault Ste. Marie, Ontario**  
**Canada**  
**256-6202**

Have portapak and editing deck (AV Sony); SEG 1; 3210 camera; m-67 mixers; trinitron.

... "equipment owned by Continental Cable, but another fellow (Peter Stuffer) and I are the only company people that use it. We're program manager and assistant ... into letting anybody use equipment. Working on technical support to Indian Group in conjunction with ALIP grant they're trying to get.

## EUROPE

### AUSTRIA

**Valie Export**  
**Gruennergasse 1**  
**A-1010 Vienna**  
**Austria**  
**0222-52-40-815**

... work on bio-physical developments and also on human-machine systems.

**Hermann J. Hendrich**  
**Hamburgerstrasse 10**  
**A-1050 Vienna**  
**Austria**  
**0222-57-00-425**

... development of alternate media with group of independent writers.

**Peter Weibel**  
**Nordbergstrasse 16/22**  
**A-1090 Vienna**  
**Austria**

... developing visual communication structures. Theoretical work on ontological foundation of communication and perception.

## ENGLAND

**Vertical Hold**  
**21c, Upper Park Road, London**  
**N.W. 3**  
**England**  
**01-722-1791**

Have JVC Nivico; EIAJ Portable. ... three artists making own tapes for/with others. Also interest in community tv; documentary tapes of any nature.

**Gus Geddes**  
**Mission Control**  
**65 Harwood Street**  
**London, NW 1**  
**01-485-9467**

... works in association with artists in streets, parks, public places. Playback from van.

## GERMANY

**Norbert Nowotzsch**  
**D4501 Glandorf**  
**Weskendorf 32**  
**Honk-Farm**  
**Germany**

... experimenting with video both on our farm and at the art school in Munster (university)."

## SWEDEN

**First Generation Video, Inc.**  
**c/o Janne Arrendal**  
**Professorsalangan 7, 10405**  
**Stockholm, Sweden**  
**08-15-50-92**

Have 1/2" Sony, JVC Nivico. Also 1" Sony and Ampex.

Video workshop courses/mobile classroom/production unit/videotheatre/monitor; a monthly magnetic magazine on the media—1/2" (first five issues: report from Media-America).

## SOUTH AMERICA

**Michael Gowling**  
**Apartado Aereo 4043**  
**Medellin, Colombia**

... working with live theatre, filming group action and enlightening group awareness; full-length programming of theatre productions; social documentaries and travelogues of South America (Spanish and English).

## HAITI

**Paul E. Paryski**  
**Third Eye Farm**  
**6 Rue Traversiere**  
**Port-au-Prince**  
**Haiti**

Has Akai 1/4". Will have Sony 3650 soon. Make tapes of Haitian culture: painters, sculptors, folk culture, voodoo, les mysteres, rhythms. Also community tv interaction and mind stuff. We live in a commune in the mountains.

**FILE** invites you to re-  
gain control of the ivory  
tower.



name \_\_\_\_\_

address \_\_\_\_\_

city \_\_\_\_\_

province \_\_\_\_\_

ONE YEAR: \$2.00 for indivi-  
duals, \$5.00 for business and  
institutions (4 issues).

FILE Magazine, a transcana-  
dada art organ, 87 Yonge  
Street, Toronto, Ontario  
M5C 1S8, Canada.



BY THE PEOPLE--a project designed to catalyse local tv program origination



**THE OLD DUTCH**

48 Parkville St.  
Saugerties, N.Y.  
12487  
Ph. 914-244-4842  
Ph. 238-2238

POST OFFICE  
RURAL ROUTE  
BOXHOLDER  
LOCAL

# POST STAR

Saugerties Post Established in 1811 The Old Dutch Station Not Established in 1811

VOL. XXVII, NO. 28 SAUGERTIES, N.Y., TUESDAY, JULY 16, 1973 SINGLE COPY 15 CENTS

## Saugerties Area TV Presents First Program

**SAUGERTIES**

As previously reported in March of this year a group of students from Saugerties High School began an experiment to create a local group in Saugerties. Using portable videotape equipment, which is low-cost (compared to studio TV equipment), and flexible (it is battery run and light enough to carry on your shoulder, with instant picture and sound) the group set out to discover its town. In the few short months the experiment lasted the group covered local events such as the Easter Egg Hunt and the Saugerties Environmental Clean-up Campaign; some local shops such as a bake shop and a barber shop; people on the street; a pottery class; people in their homes.

This coming Thursday evening, July 12 at 7 p.m. on Channel 3, the group which has named itself Saugerties Area Television (SATV), will present a 36 minute edit from the 12 hours of material they gathered. The material will cover some of the highlights of the project.

In the future the group would like to continue to function as Saugerties local TV station and with other interested citizens form an organization which would serve the town through coverage of local news and events, and the creation of

programming which would be both entertaining and educational. In other words, they seek to bring TV to the local level. They hope to draw on the talents of the people of Saugerties to create a television which is personal and human, active and involving to the citizens of Saugerties.

After this first cablecast on Thursday, the group will seek to gather information on the possibilities of doing this on a regular basis.

In order for this project to have taken place it was necessary to borrow the portable videotape equipment from Beryl Korot in Ruby, N.Y. The project was funded by America the Beautiful Fund of New York, and was coordinated by Ms. Korot and Natalie Daley, a social studies teacher at Saugerties High School.

The newly formed group, Saugerties Area Television, is investigating ways in which they can raise money for a portable video unit to be used to serve the people of the town and village. Any people interested in learning more about the plans of the group or in learning more about the plans of the group or in helping out can call Ray Christianna at 246-8321 or Paul Rodriguez or Sheri Vadalma at 246-6178.

Your interest will be welcomed.

The situation for community cable in Saugerties is as follows:

Vidi-Com cable system in Saugerties is owned by a man who lives in Liberty, N.Y. In Liberty, through the local schools, he is developing the system for local origination. For \$10,000.00 the cable owner is proposing that the Saugerties schools "buy" a head-end for which Vidi-Com will provide maintenance. The schools, however, cannot afford the investment at this time (though independently they have raised money to purchase 1/2" studio equipment which they use primarily for taping programs off-air for playback in the classroom).

Aside from this offer to the schools no plans are being made at present to provide Saugerties with the necessary equipment for local origination, though the town will have 3500 subscribers shortly. Recently, the FCC has gone on record to accommodate cable stations in existence prior to the 1972 3500 ruling by granting them a moratorium on implementation of the ruling until 1977. (Saugerties presently has 12 channels used entirely for importation of distant signals with considerable redundancy.)

At present, therefore, it is up to the students who worked on the project and interested Saugerties citizens who have gathered together as a result of this recent experiment (see article printed above) to form an organization (which they are doing) which goes on record as having the interest, talent, desire to help a local origination project in the town become a meaningful experience for the town. There is no legal imperative hanging over the cable owners head to implement local origination before 1977. It is a matter then of convincing the cable owner that the inevitable investment, if made at this time, would be beneficial because of the present goodwill and ripe energies of this new organization to help raise revenue from within the town in support of a local station.

Furthermore, the students have permission to use the school's equipment on a limited basis. They can make good use of that loan in stimulating local support by creating programming of interest to the community and playing it back through the head-end on channel 3, one of the redundant channels (both the local cable manager in Saugerties, and the Liberty owner, who has just learned of the recent experiment, have agreed to this).

*Note: The State Cable Commission recently required Saugerties Vidi-Com to file a routine renewal application with them outlining any present plans, or reporting on present service to date. The Commission also called on citizens of the area the cable system serves to file any comments, objections, etc., they might have with Vidi-Com service. The Saugerties group (which has not yet legally organized) filed a letter with the*

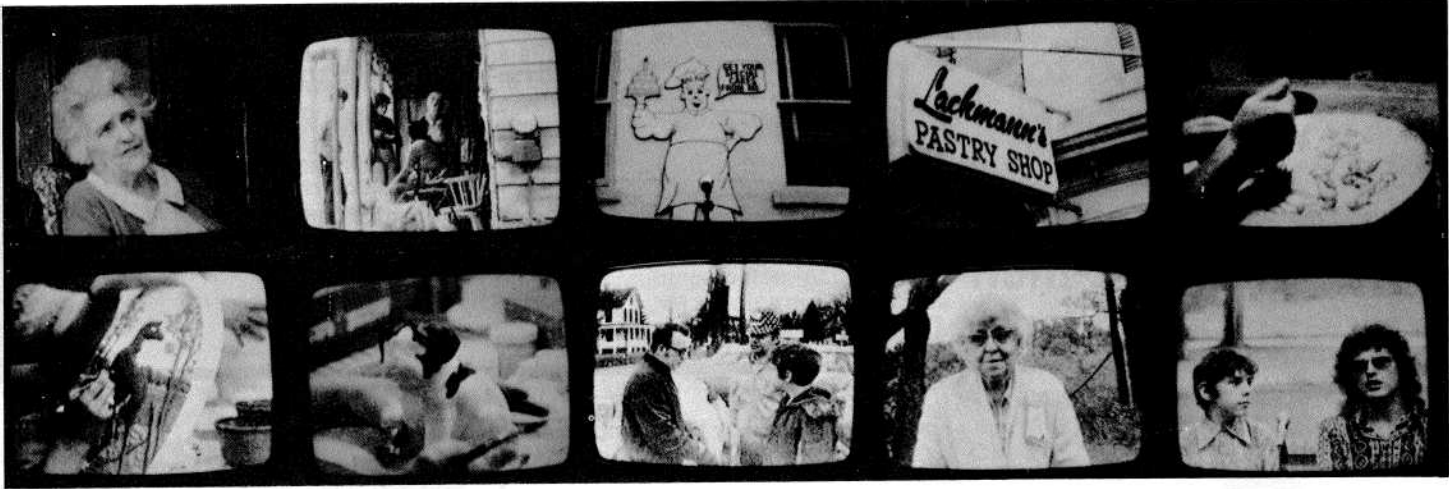

Commission reporting on the recent local programming experiment which they are working to have continued; in addition, they stated that the Vidi-Com system in existence since the early 60's had still not provided uniform, adequate technical installations throughout their system, or provided service for all those who desire it. Simultaneously, they mailed a friendly letter to the Liberty owner expressing their interest in exploring the possibilities for local origination in Saugerties.

Descriptions of your experiences with CATV community experiments are welcomed, both to be passed onto the Saugerties group and for possible publication in a future *Radical Software*. Please address your feedback to: Saugerties Area Television (SATV) c/o Raindance, POB 135 Ruby, N.Y. 12475.

A 40 minute edited tape of the Saugerties experiment is available from the same address. Part of the proceeds from the sale of this tape will go directly towards helping the group continue.

## RECOMMENDED PUBLICATIONS DEALING WITH CATV:

*Cable Television* by the Network Project (see article by them in this issue on Domestic Communications Satellites)—this booklet reports on the evolving structure of cable television, a system touted for its revolutionary potential but thwarted by those who economically or politically control it —“large cable system owners are buying up smaller systems in an effort to become leaders in what promises to be a multi-billion dollar industry.” These conglomerates are supported in their activities directly and indirectly (through lack of courageous leadership and commitment to a democratic form of communications system) by research institutions, the FCC, government. The process by which this is happening is clearly outlined.

For this booklet send \$2 to The Network Project, 104 Earl Hall, Columbia University, NYC, NY 10027.

*CATV Systems (directory, map service, and handbook)*—this atlas and glossary of cable systems provides statistical information on all operating cable stations in this country, latest FCC rulings, a sample franchise ordinance, a listing of CATV publications and associations, congressional committees and federal agencies designing legislation for cable, the NCTA advertising code, and more . . .

It costs \$8.95, is well worth the price, and may be ordered from Communications Publishing Corp., 1900 West Yale, Englewood, Colo., 80110.

*Community Video Report* by the Washington Community Video Center—this newsletter reports on video community activities in the D.C. area and around the country. It is a collection of community experiences/tape listings/tape showings. Their first issue is Summer, 1973; \$1.50 is the rate for individuals for forthcoming reports for the remainder of the year. Write to: Community Video Report, c/o Washington Community Video Center, 2414 18th Street, N.W. Washington, D.C. 20009. (A tape listing is available from them on a wide range of issues: health, education, political and social change.)

*Public Access Report*—a report initiated by Survival Arts Media of New York City. Published in January, 1973, it reports on the Public Access Celebration held in NYC last summer which was designed to generate interest in and awareness of the potentialities and problems of public access television. This was done by setting-up multiple viewing centers throughout the city which both turned people onto tapes previously made, and trained them in the use of the equipment; by using Teleprompter's studio head-end to create live interactive/feedback situations which encouraged people to phone-into the studio; and by playing back tapes made at the various decentralized centers through the head-end.

The booklet includes a detailed description of the experience and design of the event, as well as the development of cable in NYC and the history of public access.

To obtain copies of the booklet send \$3 (check or money order) to Public Access Report, POB 393, New York, N.Y. 10024.

*Video Resource Directory*—with funding from the New York State Council on the Arts members of Raindance and Videofree designed and edited a booklet which reports on access to videotape equipment and presentation facilities throughout New York State. The booklet outlines access to resources at colleges, universities, museums, galleries, historical societies, libraries, schools.

To obtain the booklet write to the Film/TV Bureau, New York State Council on the Arts, 250 West 57th Street, NYC, NY 10019.

ČASOPIS ZA  
 FILM AVDIO  
 VIZUALNA  
 ISTRAŽIVANJA I  
 TV  
 O BR.V.PETEK

NEWSPAPER FOR  
 FILM AVDIO VIDEO  
 RESEARCH AND  
 TV

NUŠA & SREČO  
 DRAGAN  
 ICVC, 00001  
 TABOR 9 LJUBLJANA  
 YUGOSLAVIA  
 N50010

AKUMULACIJA DISTRIBUCIJA ODREĐENOG  
 DOGAĐAJA PREDSTAVITVE PRVI PUT PRVO OVDJE  
 UVEK  
 ACCUMULATIO DISTRIBUTION OF FIX EVENT IS  
 PRESENTING ALWAYS FIRST IN THE FIRST PLACE HERE

# Modifications to VTR equipment to provide an Improved Method of Editing 1/2-inch Videotape Recordings

This is an excerpt of material from the National Film Board of Canada Technical Bulletin #10.

For copies of this bulletin write:  
 Jean Trudel  
 Production Services Branch  
 National Film Board of Canada  
 POB 6100  
 Montreal 101, Quebec,  
 Canada.

## Introduction

Editing with any 1/2-inch videotape recorder, such as the Sony AV 3650, was a tedious and time-consuming procedure.

Successful editing with clean picture cuts at precisely the right time was dependent, to some extent, upon guesswork and good luck! Even if the editor was fortunate enough occasionally to obtain a good picture cut, he was always faced with the problem of the sound cut being double recorded equal to the distance between the erase and the record heads.

It was after a considerable amount of frustration, trying to produce low-cost video programs within a reasonable amount of time, that Robert Forget conceived a method of eliminating the guesswork and achieving satisfactory results.

He discussed his idea with a group of NFB technicians who accepted the challenge and proceeded to convert the idea into reality.

## General Requirements

Devise a system for automatic editing of 1/2-inch videotape recordings.

It must be possible to select the first and last frames and the length of each scene, so that when they are assembled by transferring from one machine to another they produce a reasonable facsimile of the results obtainable with professional equipment.

## Specific Requirements

Modify the Sony AV 3650 videotape recorders and attach a push-button-operated control system to meet the general requirements.

When editing picture and sound, together or separately, the cut at the editing point must be technically and visually "clean".

The reasons why the 1/2-inch VTR equipment did not meet the general requirements were:

- 1 Difficulties existed in manually selecting and retaining in sync the exact picture cutting points on both the original videotape and the master assembly tape. Also, the procedure could not be repeated for rehearsal prior to the actual transferring process.
- 2 A perfect cut in the associated sound track was not obtainable due to a 1.7 seconds delay between the erase head and the record head. (Fig. 1)

## Phase 1

The difficulty in selecting and retaining the picture cutting points was largely overcome by:

- (a) Stopping and starting the machines from one common switch.
- (b) Providing a method of reversing both machines so that together they would run forward and backward.

An operating procedure was then established:

- 1 Locate the first frame of the shot to be transferred by adjusting the tape manually and viewing the still frame on a monitor.
- 2 In the same way, select the last frame of the previously recorded shot on the master tape.
- 3 Reverse both tapes "in sync" for a few feet so that when they are run forward again, they will be at normal operating speed and locked before the record button is pushed at the selected editing point.

Phase 1 modifications, therefore, consisted of extending the capstan motor connections to the exterior of each machine and connecting them to one common switching circuit. (Fig. 2)

In the forward mode, all the motor wiring connections of both machines are normaled through the common switching circuit.

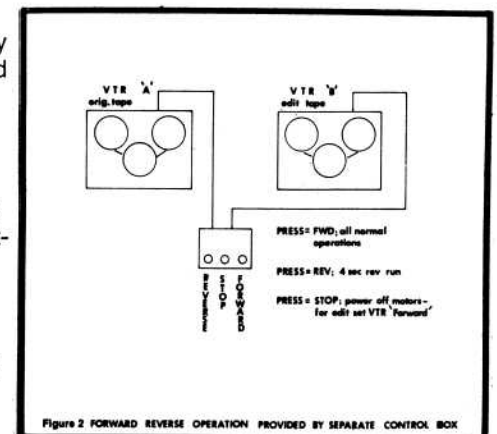
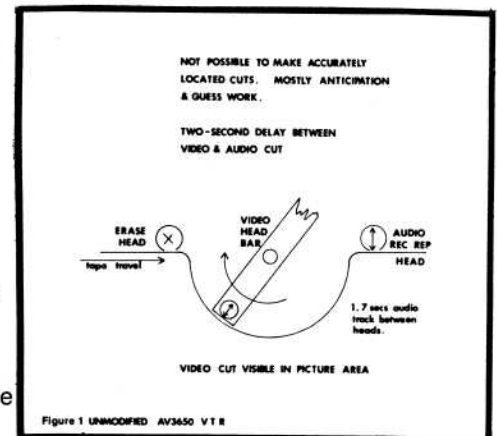

In the reverse mode, the motor wiring connections are reversed.

In the stop mode, the motor wiring connections are shorted and disconnected from the servo amplifiers. The short circuit provides dynamic braking to stop the motors instantly (Fig. 3).

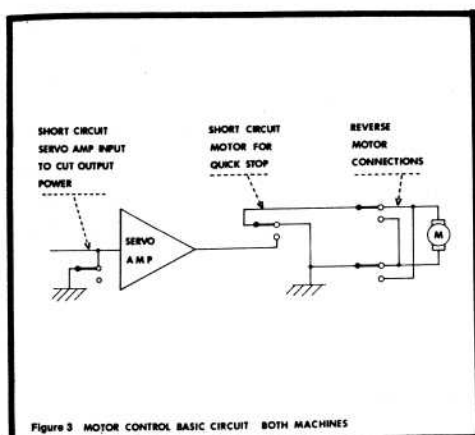

Figure 3 MOTOR CONTROL BASIC CIRCUIT BOTH MACHINES

As an additional safety precaution, the inputs to the motor servo amplifiers are shorted to prevent them operating at full power during the switching cycle.

The schematic (Fig. 4) shows the common switching circuit in the relay-operated control box.

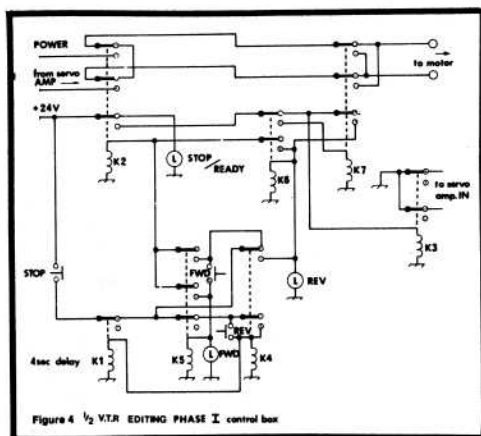

Figure 4 1/2 VTR EDITING PHASE I control box

K2 and K7 perform the motor switching operations.

K3 short circuits the servo amplifier inputs.

K1 is a delay relay that operates the drive motors in the reverse mode and stops the tape after four seconds.

The associated forward/reverse operations are controlled by other relays and they are interlocked to prevent a change in direction without first selecting the "stop" position. This allows the machine to come to rest each time to avoid damaging the tape.

The AV 3650 recorder was not originally designed to operate in the reverse mode. When the drive motor is modified to operate in reverse, the supply reel will not take up tape because it does not have a mechanically driven pulley.

The push-button and relay control box was designed to include an automatic stop at the end of the reverse mode, to allow the operator to give all his attention to the "tricky" business of reverse winding both supply reels at the same time.

Improvements to the sound editing operation during the Phase 1 modifications consisted only of eliminating the Sony delay circuits and permitting double recording at the edit point. Further studies of the inherent delay problems were required; solutions were found during the experimental stages, and were then incorporated into Phase 2 modifications.

## Phase 2

After some practical experience with the Phase 1 system, the possibilities of improving the editing system became apparent, and they are tabulated as follows:

- 1 Devise a means to mechanically operate the supply reel in the take-up mode when running in reverse.
- 2 If the length of the short run in reverse of both machines could be controlled by a time-delay circuit, it should also be possible to incorporate a method of switching the record function at the appropriate time and hence automate the editing routine.
- 3 If the switching of the record function can be made to operate automatically, it follows that it should also be possible to make the cut in the vertical interval.
- 4 If the bias to the video erase head, the audio erase head and the audio record head were controlled by time-delay circuits, then a clean sound cut could be obtained at the same time as the picture cut to produce an almost perfect editing sequence.

## Credits

*Concept Initiation:* Robert Forget  
*Concept Development:* Youssef Hasrouni  
*Mechanical Development:* Lester Dupuis and Anthony Zsiros  
*Drawings:* René St-Germain  
*Photography:* Jean Trudel  
*Author and Technical Coordinator:* Leo O'Donnell  
*Project Directed by:* Leonard A. Green



Dear Andy,

The other day I was shooting tape of airplanes flying over Manhattan. I noticed black specks on the video monitor when I played back the tape. These specks did not move even when the camera was moving. What's wrong?

Sincerely,  
Spot

Dear Spot,

The black specks you see are caused by little pieces of dust and dirt and crud which fall on the faceplate of your vidicon tube. This dust is difficult to remove because more dust can fall on the vidicon while you clean it. I had hoped to have a foolproof method of cleaning the tube before receiving your letter, but I guess omniscience is not enough. At every rate, here is my technique which doesn't work everytime, but will eventually get most of the filth off your tubes.

1. Remove the lens (removing the lens at other times should be avoided because dirt only gets on the tube when the lens is removed).
2. Remove the chrome ornamental ring.
3. Observe that there are six screws of two different sizes which secure the lens mounting assembly to the camera body. Unscrew the three larger screws with a Phillips screwdriver and remove the lens mounting assembly.
4. Drip a drop of menthyl alcohol or kodak lens clearing fluid on the glass faceplate of the vidicon tube.
5. Swab the tube face with lens tissue.
6. Dry the tube face with a dry head cleaning tip or other piece of chamois cloth.
7. Reassemble camera. The little indicator mark on the lens mounting assembly should be up.
8. Put the camera on standby and hook it up to a monitor or TV receiver via RF.
9. To check: close the lens, then open it one stop. Point the camera directly at a 100 watt bulb. Any dust on the tube will be silhouetted by the bulb. If there is still dust on the tube (and there usually is the first time), go through this whole routine again. Even if you have to spend an hour at it. A clean vidicon is worth the hardship.

*One last note: canned air doesn't seem to work as well as I had hoped.*

*The dust seems to stick to the tube due to a static charge which even very powerful canned air can't overcome. Perhaps a compressor would serve to clear the dust away.*

Tenderly,  
Andy Mann

#### Tips from Andy Mann

I have been using a BP-30 for a year and have personally not had any trouble with it. However there is a lot of concern among videotape makers over the BP-30's unreliability and its fondness for exploding.

*I recently was driving a car in which a friend was charging his BP-30, one which had been damaged and supposedly repaired. The charger plugged into the car's cigarette lighter. We were on US 13 doing 50 mph when the battery blew up, cracking the windshield and causing me to pull over to the side of the road. I threw the remains of the battery out of the car and it exploded again, and then a third time. The explosions were about the same magnitude as a blasting cap. That was when I decided to write this article.*

I here present you with my own way of dealing with the little critters.

1. I never charge a BP-30 unless it is completely exhausted. You can tell it is exhausted when the battery meter on the AV-3400 reads in the red. Exception: before going out to shoot, I try to charge my battery for about one hour in order to peak it up.

2.a. I have never used the charger that comes with the BP-30. Instead, I replaced the charging connector with an .085" co-ax plug, such as the one found on the BP-20, and used the AC-3400 to charge my battery. Since the AC-3400 shuts down when the battery is fully charged, there is no problem with over-charging. I have been told that this is not a good way to charge the BP-30, but I am satisfied that it works. (The battery is charged in 7-10 hours and should then be removed from the charger.)

2.b. When attaching the .085" co-ax plug to the battery charging leads, the red (+) lead is soldered to the shield, and the black (-) lead is soldered to the center conductor. If these two leads short together the battery burns up.

3. The greatest advantage of the BP-30 is not necessarily its greater capacity but the fact that it is an external battery. The AV-3400 is much easier to carry without an internal battery. I wear the BP-30 on a belt around my waist.

4. BP-30's will only explode if they are abused. Sony only packages them; most BP-30's being manufactured by Gould, Inc., a reputable concern. A battery can be over-charged and overheated until it shorts out and explodes, or it can be dropped and damaged and explode while charging, but with proper care, spontaneous detonations are unlikely. To be on the safe side, try to charge the BP-30 in a cool out of the way place where even if it does explode, at least nobody will get hurt.

*Incredibly enough, after writing this article I managed to accidentally short the battery out when the charging leads in my just broken .085" co-ax plug touched. The battery heated up in a few seconds and melted some of the plastic which encases the Nicad cells. The battery still works, but I feel a little foolish. It was my fault and not that of the BP-30*

*Spaghetti City Video Manual* by Parry Teasdale and Videofreex (Praeger Books)—look for this guide to maintenance, use and repair of ½" videotape equipment. Available at your local bookstore or contact Praeger.





**TECHNISPHERE ANNOUNCES THE INTRODUCTION  
OF THE MOST ADVANCED HALF INCH EDITOR  
AVAILABLE TODAY**

TECHNISPHERE CORPORATION has now refined the Panasonic NV-3130 to provide the most versatile half inch editor available. We now offer on an exclusive basis to our customers a VTR with an editing capacity previously found only in one inch machines of three times the cost.

The TC-3130 will now provide three modes of editing, (1) assembly, (2) insert with audio, and (3) VIDEO INSERT ONLY. A sound damping circuit has been added to eliminate the click at the edit point. Also for trouble free maintenance electronic switching has been provided.

TECHNISPHERE's model TC-3130 is designed to the specifications of the new EIAJ recommended color standard and is fully compatible with EIAJ #1 standard for recording and playback in black and white.

Please call or write for prices and additional information.

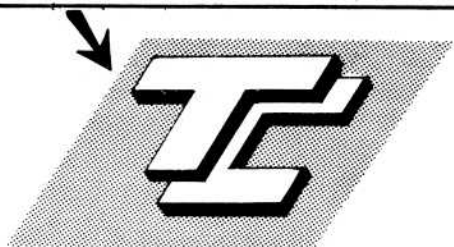

**TECHNISPHERE CORPORATION**

141 LEXINGTON AVENUE • NEW YORK, NEW YORK 10016

**(212) 684-3136**

**Rental • Sales • Service • Research • Engineering**

As of October 1 TECHNISPHERE will be located at 215 East 27th St., NYC.

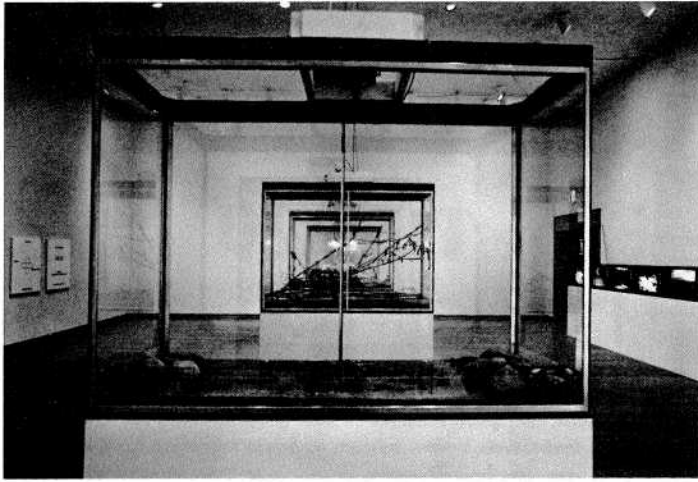

*Terraquae*. A single internal sync television camera scans snails and crabs from above. Three other environments are in the background. Information is displayed on the *Integration Matrix* of monitors at the right. Gallery C, facing west.

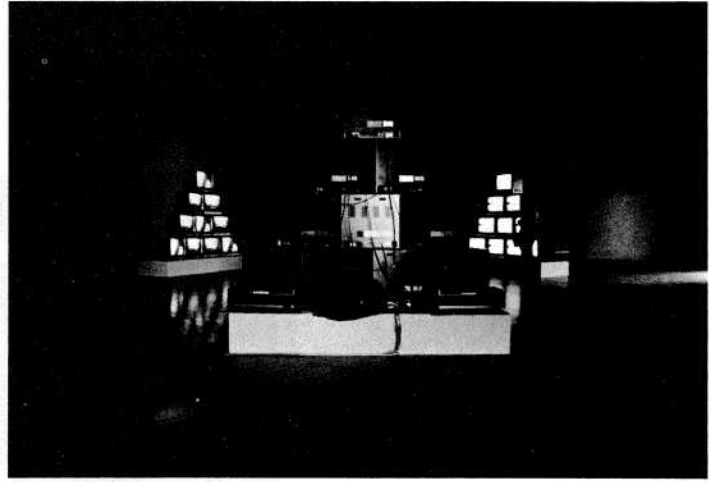

*Tetragramaton*. Each stack of ten GBC 17" monitors is fed by two JVC 3/4" cassette playback decks. Gallery B, facing northeast.

Photos: Kerby Smith

# Frank Gillette

Everson Museum of Art, Syracuse, New York

Although the Everson Museum of Art in Syracuse has exhibited the works of many video artists in the past, the recent month-long exhibition devoted to artist/theoretician Frank Gillette was the first time any Museum has used its entire facility to display the works of a single artist working in video. Gillette's exhibition at the Everson was held between May 19 and June 18, 1973.

Gillette gained recognition as an early maker of 1/2" video tapes, as the co-founder of Raindance, and as a lecturer and author of *Between Paradigms*, a mythological text connecting classical modes of thought with systems theory and cybernetic principles. His exhibition at the Everson included a videotape retrospective and a series of unique information environments which incorporated television as one of their elements.

Gillette believes that the traditional perception of man as separate from and superior to nature has provided an ideological basis which encourages technology to ravage nature and thus threaten man. The Everson environments juxtapose biological and technological processes and suggest that man, nature and technology are all parts of a unity. Television is used as one of the new references which re-relates these elements; because Gillette uses its processes (rather than just its images) as a compositional element, he augments the definition of its scope and purpose.

Many of his environments, such as *Track/Trace*, *Gestation/Growth*, *Subterranean Field* and *Terraquae* consist of closed ecological systems which are scanned by television cameras and fed back on monitors as information. Thus the spectator is able to experience the actual process, as well as the televised information of the process; his participation in both produces a third, or meta-level.

by Judson Rosebush, Everson Museum of Art

Each of these environments possess different characteristics. In *Gestation/Growth* chicken eggs hatch and the chicks grow to maturity; thus the processes inside the environment are both discontinuous and continuous. In *Subterranean Field* termites eat random patterns in wood veneers. In *Terraquae* five separate closed environments depict various ecological processes, such as metabolic exchange, symbiosis, birth/death, decay/growth. In *Track/Trace* a pyramid of monitors displays the contents of a Museum gallery so that the viewer experiences himself as information, both in real and delayed time and from different points in space.

The televised information from all the different systems is displayed on a single *Integration Matrix*, in which the viewer can explore the nature of the similarities and differences of the various systems.

In the remaining work, *Tetragramaton*, 30 television monitors are placed equidistant around a 25 foot diameter circle in three sets of ten. Each stack receives two different channels of video information, creating a multi-screen triangle of moving images. In all six channels of video information surround the viewer with images outside the gallery: oceans, forest, ponds, birds and clouds, and a single audio track unifies the work.

The Everson has published a comprehensive catalogue of the exhibition, which includes articles by James Harithas and David Ross of the Everson, as well as the text of a Willoughby Sharp interview of Frank Gillette, an illustrated description of the video tape retrospective, and an extensive description of the pieces in the exhibition. The 44 page catalogue contains numerous pictures and illustrations and is available from the Everson Museum of Art in Syracuse, N.Y.

**Frank Gillette: Catalogue of the Exhibition at the Everson Museum of Art. 44 pages text, illustrations and photographs at \$3.95 each. Published by The Everson Museum of Art, 401 Harrison Street, Syracuse, New York.**

The Everson also has available the following video tapes in any helical format: *Frank Gillette Video Catalogue* (short excerpts of all tapes), 60 min. B&W, \$75. *Willoughby Sharp Videoviews Frank Gillette*, 60 min. B&W, \$50 rental, \$300 purchase.

Information about the rental and purchase of all Frank Gillette video tapes included in this exhibit is available upon request.

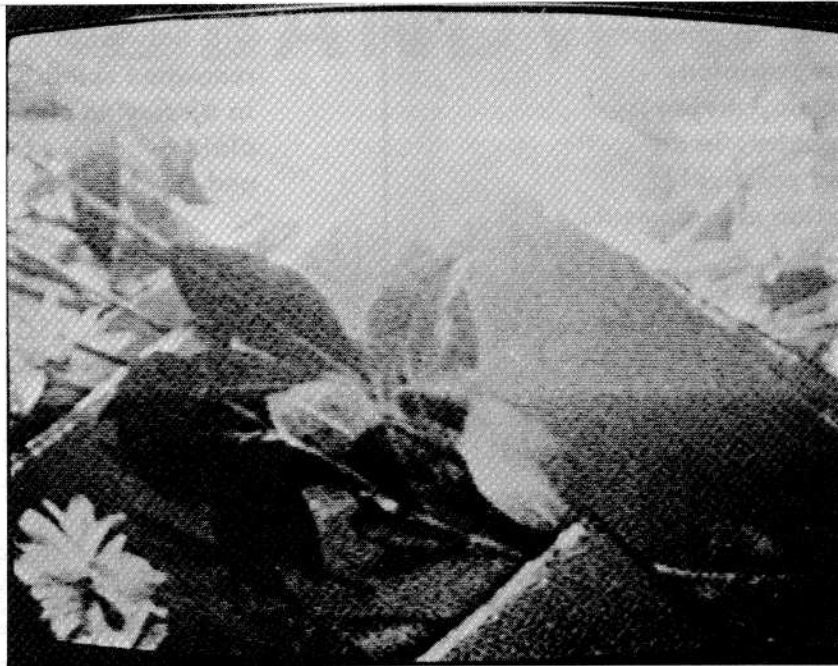

FRANK GILLETTE'S BOOK **BETWEEN PARADIGMS**  
IS AN INTEGRATED CONCEPTUAL/VISUAL WORK OF ART  
EMPLOYING A RANGE OF CONTEMPORARY IDEAS AND  
MODELS AS COMPOSITIONAL ELEMENTS. 12 COLOR  
PLATES, 48 PHOTOGRAPHS. AVAILABLE THROUGH THE  
PUBLISHER: \$4.50 PAPER, \$9.50 CLOTH.

AN INTERFACE BOOK, PUBLISHED BY:

GORDON AND BREACH  
ONE PARK AVENUE  
NEW YORK, N.Y. 10016



## SOCIAL CHANGE

SOCIAL CHANGE is an attempt to integrate fact and value; an attempt to utilize hard science, opinion, radical analysis, polemic, review, speculation, and/or poetry, in an effort to depollute and positively influence our information environment.

We think sharing information of this kind is as vital to humans as water is to fish.

We know that eventually man must become planet enhancing rather than planet destructive; we seek to foster this change.

The following titles comprise the first group of books in the SOCIAL CHANGE SERIES:

- TimeForms: Beyond Yesterday and Tomorrow—V. Gioscia
- How Behavior Means—A. Schefflen
- Birth and Death and Cybernation—P. Ryan
- Between Paradigms: The Mood and Its Purpose—F. Gillette
- Earthchild—W. Brodey
- Footholds—P. Slater
- Galaxies of Life: The Human Aura in Acupuncture and Kirlian Photography—Edited by S. Krippner and D. Rubin
- Towards a Radical Therapy: Alternate Services for Personal and Social Change—T. Clark and D. Jaffe

## PSYCHIC STUDIES

PSYCHIC STUDIES is a book series that will draw on the knowledge of world-renowned scientists, artists, and teachers, in discussing and analyzing telepathy, clairvoyance, precognition, psychokinesis, and psychopharmacology.

Tentatively scheduled for publication are works on symbolic experience and the imagination, LSD experimentation, psychic coincidences, transpersonal psychology, and a study of altered states of consciousness that uses as its basis a new theory of mind-body physics.

Dr. Stanley Krippner, Vice President of the International Association for Psychotronic Research, and Director of the Dream Laboratory at Maimonides Hospital in New York, will serve as Series Editor for PSYCHIC STUDIES.

Dr. Krippner will also serve as editor of the new Gordon and Breach journal, PSYCHOENERGETIC SYSTEMS.

### ORDER FORM

Please send me the following SOCIAL CHANGE titles:

HOW BEHAVIOR MEANS (\$10.95 cloth, \$4.95 paper) \_\_\_\_\_

BIRTH, DEATH, AND CYBERNATION (\$9.95 cloth, \$4.95 paper) \_\_\_\_\_

BETWEEN PARADIGMS (\$9.95 cloth, \$4.50 paper) \_\_\_\_\_

GALAXIES OF LIFE (\$12.50 cloth, \$6.50 paper) \_\_\_\_\_

TOWARD A RADICAL THERAPY (\$12.50 cloth, \$5.50 paper) \_\_\_\_\_

TIMEFORMS, EARTHCHILD, and FOOTHOLDS are still in preparation

I'm hooked on PSYCHIC STUDIES. Please send me detailed information on the series and the PSYCHOENERGETIC SYSTEMS journal as soon as it becomes available \_\_\_\_\_

NAME: \_\_\_\_\_

ADDRESS: \_\_\_\_\_

CITY: \_\_\_\_\_ STATE: \_\_\_\_\_ ZIP: \_\_\_\_\_

*Gordon and Breach, One Park Avenue, New York, N.Y. 10016*

---

---

# PICTURE BANDWIDTH COMPRESSION

Edited by  
Thomas Huang and Oleh Tretiak

---

---

A SERIES OF PAPERS THAT PRESENT INFORMATION ON THE EFFICIENT CODING OF PICTURES FOR TRANSMISSION OR STORAGE. IMPORTANT NEW TECHNIQUES IN CODING BINARY, MONOCHROME STILL, MONOCHROME MOTION, AND COLOR PICTURES.

CONTENTS IN BRIEF: The Human Observer, The Medium and the Message. Theory. Binary Encoding. Inter-frame Encoding. Color Pictures.

740 pages. \$29.00 special offer from the publisher.

Gordon and Breach  
One Park Avenue  
New York, N.Y. 10016

# NATURAL LIFE STYLES

NATURAL LIFE STYLES is a bi-monthly information exchange. It's home spun, youth oriented, and features recipes, book reviews, organic gardening aids, shopping tips, "how to" articles--anything that will help you live more naturally and artfully. Importantly, NATURAL LIFE STYLES' information is as valuable and relevant to city people as it is to country folks. From helping you build your own house, to cooking up a stew, NATURAL LIFE STYLES "takes the time and the trouble to do a full job."--THE WHOLE EARTH CATALOG

SUBSCRIPTION: \$9.00 Individual  
\$29.50 Library

# COUNTERPLAY

If you know what the counterculture is--is there a counterculture?--you should know about, and read, COUNTERPLAY. Four times yearly, COUNTERPLAY will take comments, articles, cartoons, artwork--whatever--from a variety of "underground/overground" sources, and run them through a thematic assumption. The first issue is "The Radical as Hero"; the second is "The Radical as Victim." Independent of the anthology framework will be the original fiction and non-fiction contributed by readers. Film, cocaine, politics, and games are just some of the topics that are covered in the first issue.

\_\_\_ When the first issue of COUNTERPLAY is ready, please let me know

# WOMEN'S STUDIES

AN INTERDISCIPLINARY JOURNAL

WOMEN'S STUDIES studies women. In history and current novels, in labor relations and love sonnets; in all the roles, and triumphs, and disasters. Three times per volume, WOMEN'S STUDIES examines literature and language, political science and art history, anthropology and psychology; it also publishes short fiction, poetry, and film and book reviews. The end result is a journal that chronicles changing consciousness, that explores the implications of feminism for scholarship and art, and that finally tries to help create a more equalitarian society--for women, and men.

SUBSCRIPTION: \$10.00 Individual  
\$29.00 Library

If your local bookstore doesn't carry Gordon and Breach magazines, tell us, and we'll try and do something about it.

*Gordon and Breach, One Park Avenue, New York, N.Y. 10016*



Juan Downey

Ira Schneider

Beryl Korot

Frank Gillette

WE ARE AVAILABLE TO COLLEGES, UNIVERSITIES, MUSEUMS, ETC . . . .

FOR

SYMPOSIA  
LECTURES  
WORKSHOPS  
DEMONSTRATIONS  
PERFORMANCES  
ENVIRONMENTS  
RAPS  
CONSULTATIONS

ON

MEDIA ECOLOGY  
(VIDEO  
CYBERNETICS  
VISUAL ARTS  
ARCHITECTURE  
FILM  
PRINT)

CONTACT: ELECTRONIC ARTS INTERMIX, 2 West 13th Street, New York, N.Y. 10011.  
212-989-2316.



# Changing Channels